

Caucasus Journal of social sciences

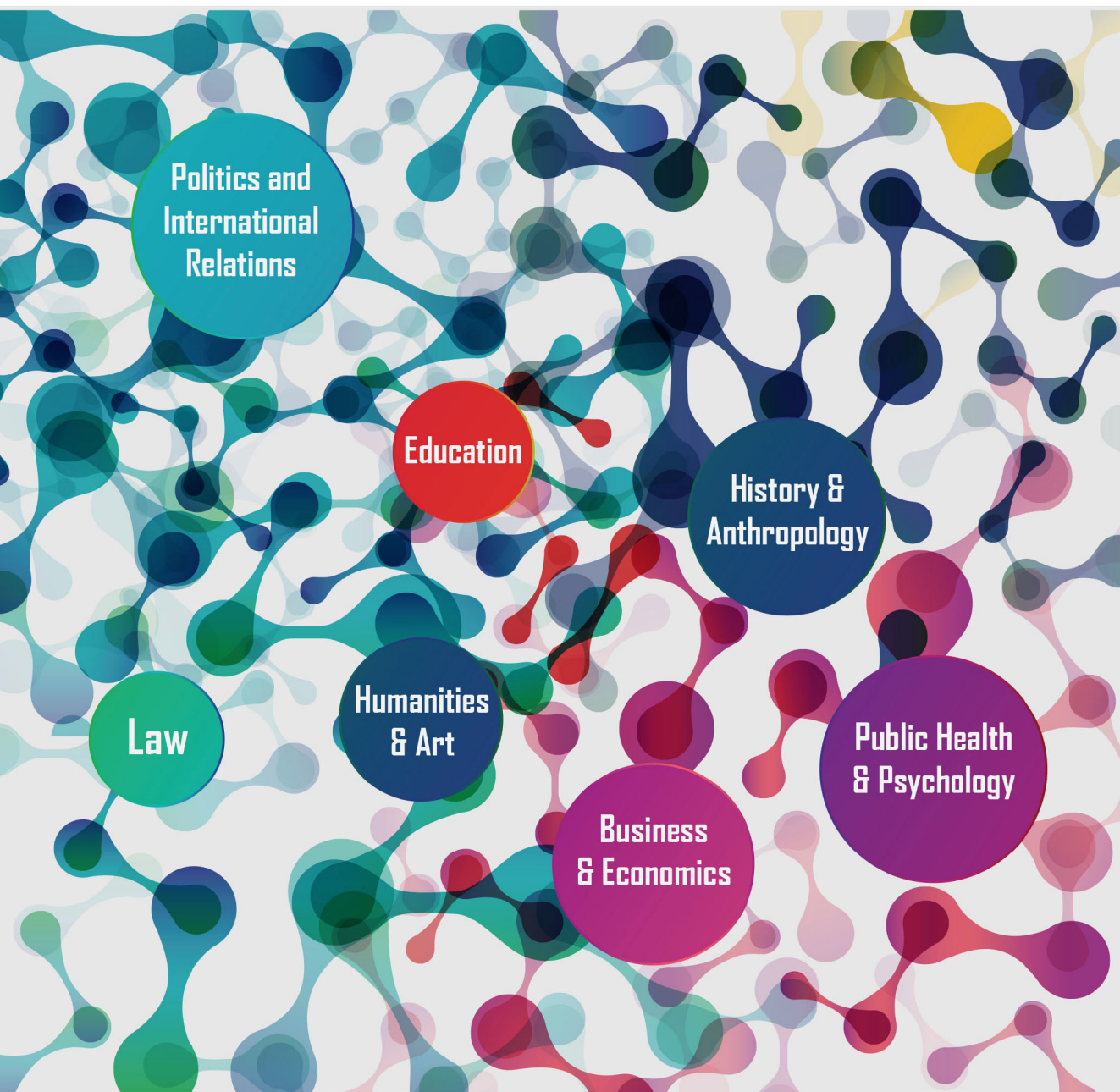

Volume 5, 2012

ISSN 1512-3677



UDC(93) 908 (479) (06)
3144

Printed at The University of Georgia,
Tbilisi, Georgia.

Copyright © 2012 by the University of Georgia. Permission to make digital or hard copies of part or all of this work for personal or classroom use is granted without fee provided that copies are not made or distributed for profit or commercial advantage.

All rights reserved. No part of this publication may be reproduced, in any form or any means, electronic, photo copying, in other works, without prior written permission of The University of Georgia Publishing House.

No responsibility for the views expressed by authors in the Caucasus Journal of Social Sciences is assumed by the editors or the publisher.

Caucasus Journal of Social Sciences
The University of Georgia.
Georgia, Tbilisi, 0175.
M. Kostava Street 77 a, Building V.
Tel: (+995 32) 24 11 44

Email: cjss_editor@ug.edu.ge
cjss_editor@yahoo.com

Copyright © 2012 The University of Georgia

Caucasus Journal of Social Sciences

ISSN 15123677

Caucasus Journal of Social Sciences

Editor

Marat Akopian

Managing Editor

Julieta Andguladze

Board of Editors

<i>Abuladze Kote</i>	<i>Tbilisi Teaching University Gorgasali</i>
<i>Akopian Marat</i>	<i>The University of Georgia</i>
<i>Alasania Giuli</i>	<i>The University of Georgia</i>
<i>Beradze Tamaz</i>	<i>The University of Georgia</i>
<i>Blauvelt Timothy</i>	<i>American Councils</i>
<i>Carper Mark</i>	<i>The University of Alaska Anchorage</i>
<i>Davies Janette</i>	<i>Oxford University</i>
<i>Gudushauri Tinatin</i>	<i>The University of Georgia</i>
<i>Goff Ken</i>	<i>The University of Georgia</i>
<i>Kakachia Kornely</i>	<i>Associate Professor</i>
<i>Kaladze Natia</i>	<i>The University of Georgia</i>
<i>Kazakhashvili Nata</i>	<i>The University of Georgia</i>
<i>Khomeriki Temur</i>	<i>The University of Georgia</i>
<i>Licheli Vakhtang</i>	<i>The University of Georgia</i>
<i>Nadareishvili Mamuka</i>	<i>Ilia State University</i>
<i>Raupp Edward</i>	<i>Gori University</i>
<i>Reisner Oliver</i>	<i>The Humboldt University</i>
<i>Sanadze Manana</i>	<i>The University of Georgia</i>
<i>Soderlind Ulrica</i>	<i>Stockholm University</i>

Caucasus Journal of Social Sciences

Volume 4, Issue 2

Contents

History

- Alasania Giuli
Kipchaks in Georgia 7
- Sanadze Manana
The Achaemenids in Georgia According to The Georgian Chronicle 24

Linguistics and Culture

- Gudushauri Tinatin
Syncretization Dynamics of the Religious Thinking of Georgian Mounteneers (Khevsur Beliefs) 45
- Mdivani Tamuna
Biblicisms, Interdisciplinary Language Units 50

Political Science

- Barbakadze Sophio
2nd Wave of Revolutions in the 21st Century- the Arab Spring ... 59
- Richard Rousseau
Dimensions of Russian Foreign Policy towards Georgia between Vladimir Putin's 2000 Election and the 2003 Rose Revolution 75

Sociology

- Tigran Matosyan
"Killer" Seat Belts, Feminine Drivers, and Tinted Windows: Pitfalls on the Way of Enforcement of Seat Belt Rules in Armenia 90

Public Health

- Chikhladze Nino, Pitskhelauri Elene, Pitskhelauri Nato and Skhvitaridze Natia
Georgian Health System and its Recent Impact on Health and Social Well-being 110
- Cheishvili Jilda
Engagement of Patient and Her Family Members into Cesarean Section Decision 125

Business and Economics

Bibilashvili Leli	
<i>Georgian Brands – Casually or Intentionally</i>	138
Kakubava Nino	
<i>Can Markets Benefit Public Health Services.</i>	148
Melikyan Narine	
<i>Corporate Culture as the Basis of Economic Democracy</i>	158
Tsitskishvili Rusudan	
<i>The Salesperson’s Social Influence Principles in the Process of Buying</i>	178
Marina Avalishvili-de Boer	
<i>ERM in Georgia.</i>	187

Law

Maskharashvili Khatia	
<i>Foster Care Placement and its Differentiation from Related Institutions</i>	199
Trapaidze Nato	
<i>Development and Legal Regulation of Entrepreneurial Activities</i>	214

Science and Technology

Gogodze Joseph and Uridia Merab	
<i>Georgian Research and Development System in 1996-2005</i>	228

History

ყივჩაყები საქართველოში

ალასანია გიული
საქართველოს უნივერსიტეტი

საქართველოში ყივჩაყთა გადმოსვლას მეცნიერთა უმრავლესობა 1118 წლით ათარიღებს. ყივჩაყთა ჩამოსახლებას საქართველოში როგორც დადებით მოვლენას აფასებს დავითის ისტორიკოსი. ძირითადად ასეთივე თვალსაზრისია ქართულ ისტორიოგრაფიაში. ამასთანავე, ყივჩაყების საქართველოში ყოფნასთან დაკავშირებით ლიტერატურაში აზრთა სხვადასხვაობაა. ნაშრომში განხილულია ჩამოსახლებულთა რაოდენობა, მათი განსახლების ადგილი, ინტეგრაციის ხარისხი და ურთიერთობა ადგილობრივ მოსახლეობასთან. ნაშრომში გაზიარებულია აზრი მათი სამხრეთ და სამხრეთ-დასავლეთ საზღვრებზე დასახლების შესახებ; გაზვიადებულად არის მიჩნეული დავითის ისტორიკოსის ნაშრომში მითითებული რიცხვი 40, 000 და მცდარად შეხედულება მოგვიანებით მათი რიცხვის გაზრდის შესახებ. სტატიაში უარყოფილია შეხედულება ყივჩაყთა სწრაფი ასიმილაციის შესახებ ზოგიერთი გამონაკლისის გარდა, გამოთქმულია აზრი მათი ძირითადი ნაწილის სამშობლოში დაბრუნების შესახებ დავითის გარდაცვალების შემდეგ. ნაშრომში განხილულია ყივჩაყების სტატუსი საქართველოში თამარისა და მის შემდგომ ხანებში.

Kipchaks in Georgia

Alasania Giuli
The University of Georgia

The Turkic peoples who settled in the North Caucasus had active communication with those who lived in the North as well as the South Caucasus including Georgians. Since the Early Middle Ages, various kinds of relations can be traced between them: cultural and economic interactions as well as frequent wars. Since the North Caucasus had been densely populated and frequently filled up by newcomers, migration to the South was a regular process. Search for new fertile lands—not always a peaceful activity—was accompanied by invasions and onslaughts, resistance from natives, massacres or expulsions of people on both sides. However historic memory has preserved some positive experience in relations between the Turkic migrants and the Georgians, frequent alliances of whom against their common opponents contributed a lot to their survival.

A new flow of Turkic people moved westward in the 11th c. The newcomers occupied a vast territory between the Volga and the Danube including the Crimean peninsula, the coasts of the Sea of Azov and the Caspian Sea, the Lower Volga and the left bank of the Yayk. The later interpolation of a related excerpt from the Georgian chronicle *Kartlis Tskhovreba* states, “Pachaniketi bordered on Ovsetia. Jiketi was located there. Much later the Pachaniks and Jiks were put to flight by the Turks, and Pachaniks went westward and the Jiks fortified themselves in the extremes of Abkhazeti” (Life of Kartli, 1958, pp. 156-157, 36, 52).

The source referred to above is a sort of an exception. All other Georgian written sources mention those newcomer Turkic people by their self-name - Kipchak, since Georgians, because of frequent contact with those people, knew their ethnic name very well. The same Kipchaks are known as Comans (Cumans) in the Byzantine and European sources, while in Slavic sources they are named “Polovtsi” (Murghulia & Shusharin, 1998, p. 13).

The newcomers turned out a big threat for their close and not so close neighbors. Evidence of some 34 incursions by the Kipchaks into the territory of Eastern Slavs and 22 campaigns by Russian princes against them in the course of the 12th c. can be found in the sources from the second half of the 11th c. and the 12th century (Murghulia & Shusharin, 1998, p. 62). Defeated by Russians several times, one part of the Kipchaks led by “Atraka, son of Sharaghan,” moved 750 km eastward (1095-1106) (Murghulia & Shusharin, 1998, p. 72). The Georgians’ relationship with the Kipchaks dates from this event.

Evidence about the Kipchaks is preserved in the chronicles written by contemporaries. These include the relevant parts of *Kartlis Tskhovreba*, and firstly, the chronicle written by David the Builder's historian. Some additional information is preserved in Arabic and Armenian sources. For comparative analysis purposes, one may also refer to the evidence from Byzantine and Hungarian sources. It is noteworthy that in some rare cases Georgian chroniclers mention the Kipchaks already in connection with the events of the ancient times. For instance, according to Leonti Mroveli, who lived in the mid- 11th c., some ruthless tribes called Bun-Turks and Kipchacks had settled on the bank of the Mtkvari prior to the coming of Alexander the Great to Kartli (Life of Kartli, 1958, p. 17). According to recent scholarly studies, Bun-Turks of the Georgian sources are to be interpreted as Scythians. The reference to the Kipchaks in this chronicle is actually one of the arguments for placing its author in the 11th c. (Biro, 1973, p. 168). In a later interpolation of the 18th c. manuscript of *Kartlis Tskhovreba* (in the part dedicated to Vakhtang Gorgasali, who reigned in the second half of the 5th c.), attributed to Juansher (6-8th cc.), we can see that Vakhtang Gorgasali "subdued the Ovses and the Kipchaks" (Life of Kartli, 1958, pp. 156-157). It has been widely accepted that the use of ethnic names in both above-mentioned cases is anachronistic.

It has been mentioned that the Georgian sources mostly use the term Kipchaks, as evidenced in the quoted cases. However, there are some other exceptions. For instance, the later version (12th c.) of metaphrastic hagiography of "Martyrdom of David and Constantine" (737), refers to "the country of Comans", who are explained as those "who are the Kipchaks." The Georgian scholar S. Jikia connected with the same word the name "Guman", mentioned in the Turkish defter, made in the late 16th c. for southern Georgia (Jikia, 1958, p. 464).

In the late 12th c., the Georgian king David the Builder, taking advantage of the start of the Crusades, stopped paying tribute to the Turk-Seljuks and began to deal with domestic problems; he defeated the domestic opposition and repulsed the invaders. According to the evidence of David's chronicler, after he stopped paying tribute, the Turks apparently were no longer able to spend winter in the Georgian lands where "[i]n Havchala and Dighuami and along the Mtkvari and the Iori they had settlements" (Life of King of Kings David, 1992, p. 168). However, we can see that the Turks did continue to camp in those regions; evidence to that effect is provided on several occasions (Murghulia & Shusharin, 1998, p. 76). For instance, recounting the events of 1110, the chronicler says: "They made camps in Gachiani, on the banks of the Mtkvari river, from Tbilisi to Bardavi and on the banks of the Iori, in all the beautiful winter places" (Life of King of Kings David, 1992, p. 177). After that follows a detailed description how they [the Turks] came in winter and returned in summer, "their power and numbers were big" and nobody could dare "to expel them and harm them" (Life of King of Kings David, 1992, p. 178).

According to the chronicler, since Georgians took Rustavi, “the Turks had no winter camping” (Life of King of Kings David, 1992, p. 189). But later the Turks also used to camp in Georgian lands: “As soon as the Turks learned that the king was far away, they camped along Mtkvari” (Life of King of Kings David, 1992, p. 188).

In 1105, after the reconquest of Kakheti-Hereti, the Georgian king defeated the Turks near Ertsubukhi. In 1110, the Georgians regained control over Samshvilde and Dzerna in Lower Kartli. They took Rustavi in 1115 and fortress Gishi in 1116, launched a campaign into Shirvan and Kaladzori in 1117 and into Agarani and Lore in 1118. All this was accomplished with a small number of troops. This is attested to by the chronicler who says that “[t]hey took Samshvilde either with skill” or “with a small army” (Life of King of Kings David, 1992, p. 172) that was led by the king personally.

But in all those years the main goal was still not achieved, as the Turks again spent winter in Georgian lands and the threat of loss of the territories was still in place. By that time the Georgian king had an ambitious goal “to join [to his kingdom] many and countless lands” - “if not so, what will be in my possession?” (Life of King of Kings David, 1992, p. 82) asked the King. To accomplish all that, the King’s army alone was not sufficient; however, he found a way out – an alliance with the northern neighbors – the Kipchaks, who, as David’s historian attests, had many attractive characteristics, such as “bravery in war, quickness in marching, fierceness in attacking inducing [their opponents] to submit” (Life of King of Kings David, 1992, p. 183; Biro, 1973). Thus, the Georgian chronicler convincingly demonstrates the need for bringing the Kipchaks to Georgia and settling them there.

By 1116, the Georgian king David IV (1089-1125) divorced his first wife, Armenian by origin, and married the daughter of a Kipchak prince Atraka, the son of Sharagan. There is a supposition that it have taken place in late 1104-early 1105. (Tsurtssumia, 2012). Reconquest of Tbilisi, which was still beyond the united Georgia, and liberation of the whole of the country from the domination of the Turk-Seljuks (“didi turkoba”) was now on the agenda of the king.

P. Golden mentions the reasons and goals why alliance with the Kipchaks was attractive to the Georgian king. “The marriage alliance with the Kipchaks reflects a broad, strategic outlook... . Like all medieval rulers struggling to create a form of government with minimal limitations placed on his authority (especially by the aristocracy), David expected to have the Kipchaks as a pliant tool for royal policy” (Margishvili, 2006, pp. 61-62). Firstly, the fact should be adduced that the Kipchaks had no property in Georgia and no clan interests, which would make them more loyal to the king. The king needed foreign warriors to restrict the power of the

Georgian aristocracy or, according to P. Golden, “to offset the power of the aristocratic clans” (Margishvili, 2006, pp. 36, 62).

A number of sources confirm that the Kipchaks easily established contacts with various peoples even those hostile to them. The Russian princes frequently married their women. Marital alliances between them are confirmed in 1163 and 1205. There are several other similar cases with no dates available for them (Murghulia & Shusharin, 1998, pp. 62-63).

After sending envoys and receiving a preliminary consent, the king together with the prime vezir, the Mtsignobartukhutsesi - Giorgi Chqondideli (bishop of Chqondidi) - went to Kipchaks and held negotiations with Ossetians to ensure a safe passage of the Kipchaks to Georgia. From the Georgian sources, we know that the king took hostages from both sides: “He established peace and love between them, as between brothers: [he took] control over the Darial fortresses and the Ossetian gates and the Caucasian mountains, and ensured a safe road for the Kipchaks”... (Life of King of Kings David, 1992, p. 184).

The precise date of bringing the Kipchaks to Georgia is not clear to the chroniclers. However the majority of scholars date this event to 1118 (I. Javakhishvili, Sh. Meskhia, M. Lordkipanidze, R. Metreveli, K. Chkhata-raishvili, G. Anchabadze, J. Stepnadze, P. Golden). This date is based on a succession of events according to David’s chronicler. I. Javakhishvili dated the “settling, training and arrangement” of the Kipchaks back to 1118-20 (Javakhishvili, 1983, p. 200).

According to David’s chronicler, bringing the Kipchaks to Georgia was a positive step. The same opinion dominates the Georgian scholarly literature. However, one may also discern a certain trend of underestimating the importance of the event. An example is served by P. Golden’s remark, who does not share the opinion of Sh. Meskhia and tries to downplay their [the Kipchaks] role (Margishvili, 2006, pp. 62).

There are some disagreements in the scholarly literature about specific issues concerning the Kipchaks’ settling in Georgia.

One such disputable issue is the locations of their settlement. According to I. Javakhishvili, the Kipchaks had both winter and summer camps in Georgia. Proceeding from the following evidence given by David’s chronicler, I. Javakhishvili supposes that Kipchak’s winter settlements were in Kartli: “The king came into Kartli and established winter settlement, food and supervisors for Kipchak families and managed all affairs in Kartli” (Javakhishvili, 1983, p. 209). In fact, according to the context, (“the king managed all affairs in Sharvan, granted a lot of gifts to Kurds, Lezgins, Tarass, went around Kartli, established winter settlement, food and supervisors for Kipchak families and managed all affairs in Kartli, Somkhiti and Anisi”) the settlements of the Kipchaks were not limited to Kartli only. However, Sh. Meskhia, R. Metreveli and M. Lordkipanidze, all shared I. Javakhishvili’s suggestion in this respect. According to R. Me-

treveli, the Georgian king was interested in the assimilation of the Kipchaks so much that he settled them on the territory of Kartli (Metreveli, 1990, p. 178).

There is also a difference of opinion as to whether the Kipchaks were settled along the south and south-western borders, were conditions are more favorable for a nomadic way of life based on cattle breeding (“he settled them with their families in more suitable places for them”) (Life of King of Kings David, 1992, p. 184) as well as more opportunities for pillage (Chkhartishvili, 1966, p.169; Murghulia & Shusharin, 1998, pp. 150, 151). According to M. Lordkipanidze, the Kipchaks were settled in Shida Kartli, northern Armenia, Hereti, on the borders of Georgia (Lortkipanidze, 1979, p. 127). The Kipchaks used to raid the neighboring areas; this becomes obvious from the following evidence of David’s chronicle, where envoys of foreign countries come with gifts “seeking peace and love, and the end of Kipchak raiding” (Life of King of Kings David, 1992, p. 198). S. Eremyan published materials, which confirmed the settling of the Kipchaks in Armenian lands. In 1206, Zakaria Mkhargrdzeli constructed a monastery called Ghfchakhvank, near Harwich. There was a village Ghfchakh. The people mentioned in the Harwich inscription, in the scholar’s opinion, are the Kipchaks; and in one inscription, there is a reference to Qubasar’s family members (Chkhartishvili, 1966, p. 169). There is a town Kipchak and a river Kipchak-Chay in Saingilo (Chkhartishvili, 1966, p. 169), at the border of historic Georgia, which is part of Azerbaijan at present. There are no Kipchak traces remaining on the Georgian territory except for the mentioning of Demetra Kipchakidze as an inhabitant of the village Chkhari in the document of 1621 (Chkhartishvili, 1966, p. 169). A. Yunusov thinks that “a center of the Kipchaks in the Middle Asia was the town Sighnaghi. The Kipchaks who were exiled to the Caucasus brought the name to a new place. That is how the village Sighnaghi in Azerbaijan and town Sighnaghi in eastern Georgia appeared” (IUnusov, 2000, p. 36). The same argument made by the Turkish scholar M.F. Kirzioghlu (1992, p. 21) is however doubtful, as it is known that the first time Sighnaghi as a town in Georgia is mentioned in the sources from the second half of the 18th c. (1762). In the first half of the 19th c., it became a royal town. N. Murghulia and V. Shusharin think that prior to that the place had been a winter camp, where Turks would come earlier along the rivers Mtkvari and Iori (Murghulia & Shusharin, 1998, p. 150).

The number of Kipchak settlers is disputable as well. The main source for this information is David’s chronicler: “He settled them with their families in more suitable places for them; 40,000 were selected for the army” (Life of King of Kings David, 1992, p. 184). The manuscript of *Kartlis Tskhovreba* attributed to Queen Mariam (the first half of the 17th c.) and the manuscript attributed to Queen Anna (15th c.) both give the

number 40,000 (Life of Kartli, 1906, p. 304; Life of Kartli, 1942, p. 214). One may see the same number in the Armenian version of *Kartlis Tskhovreba* (13th c.) (Old Armenian Translation of Life of Kartli, 1953, p. 245).

I. Javakhishvili considered the issue in different times. In his opinion, David the Builder first resettled “40,000 selected for the army” together “with their families.” Except for them, there was a slave force of 5,000, and “each [of them] became Christian, reliable and tested for bravery.” Since that time, the king had “45,000 permanently provided, deliberately trained cavalry” (Javakhishvili, 1983, p. 200). The same chronicle contains the following evidence: “David the Builder established 40,000 Kipchak warriors in Georgia”... (Javakhishvili, 1983, p. 214). If we allow at least five people for one family and recall that “40,000 plus 5,000 slaves were cavalry, we can presume then that David the Builder resettled in Georgia, at least, 225,000 Kipchaks of both genders” (Javakhishvili, 1983, p. 215). Bringing 225,000 Kipchaks to Georgia at a time when the country led by the ambitious commander and king was moving forward ceaselessly and growing, can be considered a big acquisition” (Javakhishvili, 1983, p. 215). It should be noted here that one may agree with N. Murghulia and V. Shusharin who argued that adding the slave troops to Kipchaks was not acceptable (Murghulia & Shusharin, 1998, p. 123). However, P. Golden suggests that the slave army “consisted of Kipchak and other Turkic tribesmen... together with North Caucasian mountaineers” (Margishvili, 2006, p. 62).

The estimate of 40,000 Kipchaks who together with their families settled in Georgia is repeated in the works by M. Lordkipanidze, R. Metreveli and K. Chkhataishvili (Lortkipanidze, 1979, p. 226; Metreveli, 1990, p. 178; Chkhataishvili, 1996, pp. 161-187). According to K. Chataishvili, “simultaneously 40,000 warriors fought” from 40,000 families settled in Georgia. J. Stefnadze repeated the same figure - 225,000 - suggested by I. Javakhishvili (Stepnadze, 1999, p. 207). G. Anchabadze says that the total number of the settled reached 200,000-250,000 (Anchabadze, 1990, p. 106). S. Margishvili had a different opinion: “A more realistic assumption would be that the number of Kipchak warriors who came to Georgia was 5,000, together with the families about 25,000; that would be more in agreement with the scale” (Biro, 1973, p. 98).

Based on the above-mentioned figure (40,000) and the chronicles by Vakhushti Bagrationi and Ioanne Bagrationi (18th -19th cc), the scholars are able to calculate the number of the king’s regular army. According to M. Lordkipanidze, “Except 40,000 Kipchaks, David had 20,000 Georgian regular warriors, and that makes 60,000 warriors” (Lortkipanidze, 1979, p. 228). According to R. Metreveli, “if there were 40,000 Kipchaks, it is natural that the remaining 20,000 were Georgians.” The scholar refers to Ioanne Bagrationi: “There were provided 60 thousand warriors on

wages” (Metreveli, 1990, p. 178). The suggestion by I. Shaishmelashvili was not much different: “While conducting strategic operations, except the personal guard and 40 thousand Kipchaks regular army, David the Builder summoned the royal army frequently and for protracted periods of time. It seems this part of the armed forces [the royal army] was not different from the above-mentioned regular army. Otherwise it is not possible to explain the gathering of 60 thousand army in just three days after issuing an order” (Shaishmelashvili, 1973, pp. 53-59). This opinion was not shared by G. Anchabadze. “It is doubtful that Georgia could ever have economic resources for keeping such a regular army. To our mind, the resettled Kipchaks provided a light regular cavalry, while small numbers of warriors led by their military elite, could always be with the king” (Anchabadze, 1990, p. 110). The scholar refers to the Armenian chronicler of the 12th c. Matheos Urkhaetsi about the composition of the army, which was fighting at the Didgori battle (1121).

It has been mentioned both above and noted in the scholarly literature that numbers 400, 40,000, and 400,000 are traditional in connection with the Turkic world. The evidence of Anna Comnena from 1091 is worth attention. The evidence refers to “almost 40,000 warriors, the leaders of whom were Togortak and Maniak (Boniak) and others...” (Komnina, 1996, p. 223). Roger gives the following information about the coming of the Kipchaks to Hungary, which is based on verbal sources: “As they say, they were about 40,000 without family members” (Murghulia & Shusharin, 1998, p. 95). Indeed, the same number is preserved in verbal sources. There is related evidence in the scholarly literature; after all, it was noted that Anna Comnena, Roger, and David’s chronicler all give the number of 40,000 troops, taking into consideration Kipchaks’ self-perception” (Murghulia & Shusharin, 1998, p. 95).

One may also recall here the evidence of the encounter of the Byzantine emperor Heracles and the Turks close to Tbilisi. The Turks too brought 40,000 men. The same number in connection with the north is mentioned in *Kartlis Tskhovreba* in another case, when Bagrat IV “brought 40,000 warriors from Ossetians.” Hereby one may recall the evidence of the chronicler of Queen Tamar about the number of Rum warriors brought by Rukn ad-Din Suleiman-Shah II against the Georgians in 1202: “He summoned all his army and gathered warriors of 40 times as many, which is 400,000” (Life of Kartli, p. 367).

N. Murgulia and V. Shusharin have some doubts about the number 40,000, which was indicated by David the Builder’s chronicler; they suppose that the number was much bigger (Murghulia & Shusharin, 1998, p. 96). They base their opinion on the evidence of the same chronicler, which is, in fact, misinterpreted in scholarly literature.

I. Javakhishvili indicates 50,000 in his “History of the Georgian Law”: “To empower himself, the king created an army of 50,000 warriors

from the resettled Kipchaks, trained them well and had them always ready for fighting”(Javakhishvili, 1984, p. 106).

In G. Anchabadze’s opinion, “[i]n order to ascertain the precise number of the military forces, a census was held periodically. According to the evidence of David’s chronicle, the census of 1123 showed that the number of Kipchaks who carried arms reached 50,000. Since the natural growth of population couldn’t be 20 %, it is suggested that in 1119-23 new groups of nomads from the North were resettled” (Anchabadze, 1990, p. 111).

P. Golden refers to I. Javakhishvili and shares his suggestion that the number of the settled foreigners was 225,000 (Margishvili, 2006, p. 62).

By F. Kirzioghlu, the number 225,000, which was introduced by I. Javakhishvili, was a rather low estimate. Allowing for six people in a family and counting a total of 50,000 families, he determined that the total number was as high as 300,000 (Kirzioghlu, 2002, p. 125). A. Yunusov shares this opinion (Unusov, 2000, p. 32).

N. Murghulia and V. Shusharin concluded that for determining the total number of the warriors that came to Georgia, one has to rely on the data of a census by David’s chronicler (50,000) (Murghulia & Shusharin, 1998, p. 96). Such an interpretation of the text is reflected in the Russian translation of the Georgian chronicle: “He instantly summoned all his troops. By his order, all came from his kingdom. He rose against the Sultan; and the Kipchaks, who were counted over again that time, were 50,000” (Murghulia & Shusharin, 1998, p. 215). The translation is not faithful to the Georgian original text. Before launching a campaign to Shirvan the Georgian king gathered the army and, as David’s chronicler notes, “[h]e quickly summoned all his army and by his order an army from all his kingdom gathered before him and came forward against the Sultan; the Kipchaks were counted over again; the fighters that he found, were 50,000. When the Sultan learned of their arrival, the power and size of his [the king’s] army, he was scared, left the place where he camped and sheltered himself in the city” (Life of King of Kings David, 1992, p. 194). In this context, the number 50,000 refers to the army as a whole and not only to Kipchaks. This also seems to be confirmed in the following excerpt of the same chronicle. Before taking Anisi, David once again called up his army: “He quickly sent written summons and on the third day 60,000 warriors were before him. He moved and on the third day took the city” (Life of King of Kings David, 1992, p. 197). As one can see, there is no big difference between those two numbers – 50,000-60,000. The indication of the 60,000 (in Georgian “samotsi” means “three twenties”) in the latter context can probably be explained by the desire to repeat the number “three”, which is preferable in *Kartlis Tskhovreba* because of its sacral meaning: “On the third day “samotsi” (three twenties) thousand warriors stood before him. He moved and on the third day easily took the town of

Anisi and its fortresses and villages and the lands around Anisi” (Life of King of Kings David, 1992, p. 197).

The evidence of Matheos Urkhaetsi, in which the participants of the Battle of Didgory are named one by one, seems to be more correct: “...With 40,000 strong and courageous men and warriors, experienced in warlike activities; He also had 15,000 other troops from the Khapchakh (Kipchak) king; 500 bold and selected men from the Ossetian tribe, 100 Franks” (Murghulia & Shusharin, 1998, p. 134). The evidence of the Armenian chronicler of the 13th c. Smbat Sparapet, according to which the king “gathered all his army, invited for help 40,000 Kipchaks, 18,000 Alans, 10,000 Armenians, 500 Franks” (Murghulia & Shusharin, 1998, p. 83-84), seems less reliable.

According to the Georgian chronicler, the resettlement of the Kipchaks contributed to David’s successes. Just after that, the Georgian king “began to raid Persia, Sharvan and Great Armenia” (Life of King of Kings David, 1992, p. 185). After their resettlement, the Kipchaks supposedly participated in all the king’s campaigns, no matter whether the Georgian chronicler mentions them or not.

The Arab chronicler Ibn al-Athir (13th c.) indicates that in the Battle of Didgori in 1121, which was followed by the reconquest of Tbilisi in 1122, Kurjs (Gurjs) came out jointly with the Kipchaks. This record alone is sufficient to make it obvious that the Kipchaks were the advanced guard of the Georgian army. That is why before the battle “200 men from Kipchaks came forward, entered the midst (of the Moslems) and shot arrows” (Ibn al-Athir, 1966, p.567).

An issue which draws our attention is the process of assimilation of the Kipchaks who were settled in Georgia and their relationship with the local population. According to P. Golden, “[t]he use of a large foreign army (the Kipchaks) to be settled in the country was a daring move which, had the arrangements soured, could have had a disastrous, perhaps fatal, effect on Georgia” (Margishvili, 2006, p. 61).

The evidence of David’s chronicler that “the bulk of the Kipchaks day by day became Christians and their big number was added to Christianity” (Life of King of Kings David, 1992, p. 185) in the Georgian scholarly literature is interpreted with some exaggerations. According to I. Javakhishvili, the Kipchaks who were resettled in Georgia, “learned Georgian and became Georgians and no one from their descendants was left as a Kipchak, but everybody without any compulsion became Georgian voluntarily” (Javakhishvili, 1983, p. 216).

The opinion above was shared by other scholars. However, related records fail to confirm this suggestion and present a different picture.

David’s chronicler emphasized that from the very beginning, right after the settlement of the Kipchaks in Georgia, the king tried to assimilate them; he started the process by their conversion to Christianity.

However, the process of Christianizing as well as Georgianizing of the foreigners was not so successful and their relationship with the local population as well as with the king himself was rather complicated. The chronicler does not hide the fact that the Kipchaks frequently took prisoners from among the local population, and the king was forced to pay a ransom for them: "Who can count the prisoners who were liberated by Him and were ransomed from the Kipchak relatives by fee" (Life of King of Kings David, 1992, p. 210). P. Golden suggests that problems came from Kipchaks who were not in the Georgian service and were not allies of the Georgians (Margishvili, 2006, p. 74-75). Indeed, "the Kipchaks of Daruband" are also mentioned in the source. However, this argument is not entirely convincing, since one can see that the Kipchaks, who were settled in Georgia, did not spare the Georgian king himself, frequently betraying him and organizing plots against him. "How many times the Kipchaks planned treason, installed leaders, bold, some with sword, some with spear, and others with arrows - and this was not done just once or twice or thrice, but many times. However, God never allowed to approach the crosier upon the truthful" (Life of King of Kings David, 1992, p. 222).

The foreigners were not always reliable in battles either. According to Ibn al-Athir, in 1223-4 during the siege of Shemahya, there was a confrontation between the Kipchaks and the Georgians. That is why the king was forced to raise the siege of the town just in time when the Sultan, who came to help [the besieged], intended to leave: "God gave them release... . A dispute and enmity occurred between the Kurj and the Kipchaks. They battled each other that night and departed as if they retreated" (Ibn al-Athir, 1966, p. 615-616), as Ibn al-Athir tells. It is noteworthy that there was another occasion connected with the Kipchak-Georgian alliance which took place later. As the Iranian chronicler of the 13th c. Juveyni relates, in 1228 at the battle near Bolnisi, when the foes "saw the flags of Kipchaks and 20 thousand selected men, the Sultan called Qoshkar, gave him one loaf and some salt and sent to the Kipchaks. He reminded him of the case, which took place during the reign of his father - times, when they were enslaved and humiliated... and the Sultan liberated them. For that reason the Kipchak troops retreated" (Juvein chronicles about Georgia, p. 36). However similar incidents were rare in times of David the Builder and positive relations between the Georgians and the Kipchaks prevailed.

According to David's chronicler, it is obvious that the assimilation process was not as fast, as planned and desired by the Georgian King. The chronicler credits the King with the establishment of order in the army and notes that many "multi-lingual ethnic groups with different languages" (King of Kings David, 1992, p. 208) were part of it. One may draw a parallel with the Turk-Seljuk troops, in which, according to Nizam ul-Mulk, the participation of representatives of different ethnic groups was

mandatory, since such a diversity created a competitive environment (Nizamu'l-Mulk, 1999, pp. 72-73).

P. Golden also noted that Georgian scholars overemphasized the number of the Kipchaks, who settled and remained in Georgia (Golden, 1984, p. 65). However, there are also some Georgian scholars, who came to the same conclusion. By their suggestion, the Kipchaks returned to the northern steppes after the death of David the Builder (Chkhartishvili, 1966, p. 173; Stepnadze, 1999, pp. 201-210; Murghulia & Shusharin, 1998, p. 152). Along with others, this argument is based on a Russian source – specifically, the evidence introduced by the chronicle of Daniel of Galicia, which informs us that after the death of Vladimir Monomakh the northern relatives of Atraka, the son of Sharekhan, sent envoys urging him to return to his lands: "Volodimir is dead... return, brother, come back to your own land. Say my words to him, sing him Cuman songs and if he will not want [to return], give him the grass called evshan to sniff." Nevertheless, he wanted neither to return, nor to listen. And he [envoy] gave him the grass and he sniffed [it] and broke into tears. He said: 'It is better to lay down one's bones in one's own land than to be famous in a foreign [land]'. And he returned to his own land" (Margishvili, 2006, p. 69). According to J. Stepnadze, a plot against Demetre, the eldest son of David, in 1130 could also be the reason for the return of the tribal followers of Atraka to their homeland. The goal of the plot against King Demetre was to enthrone his younger brother, born from a Kipchak princess. According to the evidence of the Armenian chronicler of the 13th c. Vardan, the participants of the plot were ruthlessly punished; among them was the brother of Demetre, who was blinded (Vardan, 2002, p. 142). That the Kipchaks might have participated in the plot is suggested by the fact that the claimant to the throne, Vakhtang, was a grandson of Atraka, the son of Sharaghan.

It seems that only a minority - those who were promoted to high positions and were close to the throne - remained in Georgia. Among them was Qubasar, who supported king Giorgi III (1156 -1184) later to quell a revolt of the Orbeli clan. For that, Qubasar was promoted to the positions of Mandaturtuhkutsesi (Interior Minister) and Amirspasalar (commander-in-chief). The Georgian chronicler says nothing about his ethnic identity; however, Stepanos Orbelian, the Armenian chronicler of the 14th c., notes that Qubasar was Kipchak (Orbeliani, 1978, p. 46). According to the same chronicler, when Orbeli rebelled against the king, the latter "summoned" Qubasar and jointly they hardly managed to gather 5,000 troops (Orbeliani, 1978, p. 46). Stepanos Orbelian reports, "[They] found about 5,000 troops and nobody else was of a helper" (46). It means that the Kipchaks, except for some of them, were not in Georgia by that time and the Armenian chronicler knows that very well. As for the indicated 5,000, this number was seemingly taken from David's chronicler, who gave this number for the slave troops who were at the king's disposal. We can not share in this case the suggestion of P. Golden that at

this time the Kipchaks were still there, in Georgia, and those 5,000 could be *mona-spa* (slave army), or, in his opinion, some Kipchak guards (Margishvili, 2006, p. 78).

The Kipchaks are mentioned in the Georgian history later as well. However, they were not residents of the country and came just at the invitation for a temporary military service. The Georgian anonym of the 13th c., "Chronicler from the Time of Giorgi Lasha," whose work is included in *Kartlis Tskhovreba*, notes at the end of his chronicle: "When he ordered some thousand men of the Ovses and the Kipchaks, they came, similarly the house of Sharvan" (Life of Kartli, p. 298). Unlike David's historian who was well-disposed towards the Kipchaks, this chronicler does not have a positive opinion of them: "The Ovses, Mtiuls (mountaineers), the Kipchaks and the Suans did not dare to engage in thievery" (Life of Kartli, p. 300), he notes referring to the reign of Tamar.

According to the so-called "first chronicler of Queen Tamar," it is clear that the Kipchaks in those times were in Georgia for a temporary military service, and they were paid for that: "In that time Savalat (Vsevolod), the brother of Sevinj, the Kipchak King, was here for service." His coming to Georgia was something new, since when the issue of Tamar's marriage was being considered, the Russian prince was mentioned, who was in the North by that time, at his uncle Savalat ("in the town of the Kipchak king, Sevinj") (Georgian Historic Documents, p. 64; Life of Kartli, p. 347). In those times, the Kipchaks were no longer a core force of the Georgian army; they were just an additional force: "Hers and Kakhs, nobles and aznaurs, with enclosed Kipchaks." They were still an advanced guard of the Georgian army as before. While describing the Battle of Shamkor (1195), the chronicler uses the terms "chalash" and "dasnach". The first - "chalish-savash" - meant war, fighting (Murghulia & Shusharin, 1998, pp. 1000-101). At the same time, fighting of advanced guards was "chalib fighting," which is mentioned by the anonym of the 14th c., the so-called "zhamtaaghmtsereli" or the "describer of the times," whose chronicle is included in the same collection *Kartlis Tskhovreba* (Silagadze, 1987, p. 34, 148-151). As to "dasnachta," according to M. Beladze, this is distorted "da sanjakta" ("and of sanjaks").

Tamar's first chronicler mentions the term "new Kipchaks" ("Ovses and new Kipchaks") (Georgian Historic Documents, p. 65; Life of Kartli, p. 348). Some scholars think that the expression "new Kipchaks" means Kipchaks who were newcomers (Stepnadze, 1999, p. 209). Along with that, some scholars introduce the expression "old Kipchaks" (Kirzioghlu, 2002, p. 122). According to these scholars, those who came in times of David the Builder, were the "old", while others who came in times of Tamar were the "new Kipchaks." This opinion is based on a wrong assumption that the Kipchaks were continuously coming to Georgia and staying there. This perception in its turn followed the wrong interpretation of the number 50,000 in the text of David's chronicler. The expression "old Kipchaks" is not found in the chronicles; it appeared in the scholarly litera-

ture. These two expressions are not equal and there is a considerable difference between them. The "new Kipchaks" did not live in Georgia and came there for a while, for a military service. The suggestion of P. Sikharulidze that the expression "new Kipchaks" probably meant the Kipchaks who converted to Christianity, just as in the 19th c. "new Kartvels" (new Georgians) meant the Georgians who converted to Christianity -- should also be taken into consideration. One may recall Ingilo "yeni gelen," which too refers to new converts, but this time the Georgians who converted to Islam (Stephnadze, 1999, p. 219). The assimilation process is reflected in the term "nakipchakari," which means "former Kipchak," early arrivals, which according to P. Golden, were "denomadized, becoming a kind of a Cossack-type force" (Margishvili, 2006, p. 64).

It seems that right from the times of Giorgi III there was established a special tribute "Sakipchake" ("for Kipchaks"). One can see evidence about this tribute in the deed issued by David VIII (1297/8) (Enukidze, 1973, pp. 183-4). According to the opinion dominating in the Georgian scholarly literature, this tribute was established by David the Builder (Gandzaketsi, 1976, pp. 33-35). However, the need for such a tribute seems more obvious in times of Giorgi III (in order to pay wages to the Kipchak mercenaries).

Later on, the relations between the Kipchaks and the Georgians became tense. The Armenian chronicler of the 13th c. Kirakos Gandzaketsi has preserved evidence about further relations between the Kipchaks and the Georgians. During the events of 1221-22 the chronicler relates that the Georgian King Giorgi Lasha (1207-1123) and his Amirspasalar (commander-in-chief) Ivane Mkhargrdzeli refused to give the Kipchaks the land for residence, in exchange for a military service. Rejected, the Kipchaks went to Ganja, which was frequently attacked by the Georgians. They were welcomed there and got the land they needed. A little later they defeated the Georgian army led by Ivane, and seized many Georgians, while the others fled. Later on, Ivane attacked them once again, defeated and took their children prisoner to Georgia (Bunyatov, 1978, p. 139).

Ibn Al-Athir gives some additional information on those years. Among the events of the year 619 (15 November 1222 - 3 November 1223), he presents information that 50,000 Kipchaks came to Daruband from the North and twice asked for a land. After their request was denied, the Kipchaks seized Daruband with trickery, devastated it, left and moved to Qabala, which was under Georgian control. They could not take Qabala, but plundered its surroundings and retreated. After that they moved to Ganja, where they somehow got land for settling. Soon the ruler of Ganja, Qoshkar, accused them of organizing some turmoil and expelled them. The Kipchaks again went to Shirvan, where they were pursued by Moslems, Georgians and Lezgins, defeated them and took prisoners. According to this evidence, the leader of the Kipchaks tried to convince the ruler of Ganja that the Georgians were their enemies and that if they had good

relations with the Georgians, they would not choose the Daruband Pass, but instead would pass through their country, as it had happened before (Ibn al-Athir, XI, 1966, pp. 406-410; Silagadze, 1987, pp. 67-78; Stepnadze, 1971, pp. 118-120).

The Kipchaks appeared in Georgia once again in David VIII's reign (1293-1311) when eastern Georgia was under political control of the Ilkhans, who had been waging incessant wars against the Golden Horde. In this situation anyone who was at odds with the Golden Horde was a natural ally for the Ilkhans and thus a subject of their concern. Just for that reason, the Ossetians came from the North and settled in Georgia. The situation was similar in the case of the Kipchaks.

As David VIII refused to obey the Ilkhans, they let his brother Vakhtang III (1298-1308) ascend the throne; in some cases Vakhtang III was forced to act against David. The Mongols allowed the Kipchaks to settle on the Georgian territory. A related evidence about this incident is preserved in the chronicle of an anonymous author of the 14th c. One can find here the evidence of the fighting between David VIII and the Kipchaks who were en route to their summer camp. David's brother Vakhtang came to help the Kipchaks. Together Vakhtang and the Kipchaks pursued David's troops and killed many. The chronicler tries to justify Vakhtang's behavior: "Actually, Vakhtang was not his brother's enemy, but was fighting him, because he was afraid of the Tatars" (Life of Kartli, p. 544). Arguably, the famous "Ballad about a Kipchak" – where a Kipchak is preserved in Georgians' memory as a negative personage - dates to these times.

References

- Anchabadze, G. Z. (1990). *Istochnikovedenie problemy voennoi istorii gruzii* [Source Study of Problems of Military History of Georgia]. Tbilisi.
- Biro, M. B. (1973). *The "Kipchaks" in a Georgian Martyrdom of David and Constantine*. Annals Budapest.
- Buniatov, Z. M. (1978). *Gosudarstvo atabekov Azerbaidzhana* [State of atabeks of Azerbaijan]. Baku.
- Chkhartishvili, K. (1966). *Uc'xoelebi XII saukunis sak'art'velos lašk'arši* [Foreigners in Georgian Army in XII Century]. Tbilisi.
- Davlianidze, L. (1966). *Mat'eos Surhaec'is c'nobebi davit'a mašeneblis šesaxeb*. In *Sak'art'velo rust'avelis xanaši* [Mateos Surhaetsi's sources about David the Builder. In *Georgia in Rustaveli Epoch*] (pp. 242-253). Tbilisi.
- Enukidze, T. (1973). *XIII saukunis qartuli samoxeleo termini "mesaqivč'aqe."* In *K'art'uli cqarot' mc'odneoba. IV* [Georgian Official

- Term "Mesakivchake" in XIII Century. In *Georgian Source Studies. IV* (pp. 183-4). Tbilisi.
- Gandzaketsi, Kirakos. (1976). *Istorija [History]*. Translated from old Armenian, preface and comments added by Khanlaryan, L. A.
- Georgian Historical Documents in IX-XIII cc. (1984). []. Collected and prepared for publishing by E nukidze, E. Silogava, V. Shoshiashvili, N. (pp. 64; 20, 347; 36; 20, 329; 65, 20, 348). Tbilisi.
- Georgian Prose. [k'art'uli proza]. (1982), I, (p. 169). Tbilisi.
- Ibn al-Athir. (1966) *Al-Kamil fi'l tarikh*, vol. I-XII. Editeurs Dar Sader, Dar Beyrouth, Beyrouth. (pp. X,615-616; XI, 406-410; 34, 67-78; 33, 118-120).
- Javakhishvili, Iv. (1983). *History of Georgian Nation*. [k'art'velt'a eris istoria]. II. (pp. 216, 223). Tbilisi.
- Javakhishvili, Iv. (1983). *Selected Works*. [t'xzulebani]. II. (pp. 200, 214, 123, 215). Tbilisi.
- Javakhishvili, Iv. (1984). *Selected Works*. [t'xzulebani]. VII. (p. 106)
- Jikia, S. (1958). *Gurjistan Vilaiet Great Book*. [gurjistanis vilaiet'is didi davt'ari]. III. (p. 464). Tbilisi.
- Juvein Sources about Georgia (1974). [juveinis c'nobebi sa k'art'velos šesaxeb]. Persian text preface, Georgian translation, and notes by Kiknadze, R. (p. 36). Tbilisi.
- Kirzioghlu, M. F. (2002). *the Kipchaks*. [k'p' 'a k'lar]. (pp. 122; 125). Ankara.
- Komnina, A. (1996). *The Alexiad*. [aleksiada] Prolusion. Translation and Comments by Lubarsky, I. N.
- Life of Kartli. („Old Life of Kartli“). [veli k'art'lis c'xovreba]. Prepared for publishing, and preface and Definitions were added by Antelava, Il. And Shoshiashvili, N. (pp. 367; 298, 300, 367). Tbilisi.
- Life of Kartli. (1906). [k'art'lis c'xovreba]. Mariam Dedoplian Version. Published by Takaishvili, E. (pp. 304; 14, 214). Tbilisi.
- Life of Kartli. (1942). [k'art'lis c'xovreba]. Ana Dedoplian Schedule. Prepared by Kaukhchishvili, S. Tbilisi.
- Life of Kartli. [K'art'lis C'xovreba]. (1955). I Text. Stated according to basic manuscript by. S. Kaukhchishvili. pp. 156-157, 36, 52
- Life of Kartli's Armenian Translation Published with the Research and Dictionary by Abuladze, I. (1953). (p. 245). Tbilisi.
- Life of the King of Kings David. [c'xovrebay mep'et'-mep'isa davit'isa. (1992). Text edited, researched; dictionary and index added by Shanidze, M. (pp. 168, 177, 188, 182, 183, 184, 198, 197, 185, 222). Tbilisi.
- Lortkipanidze, M. (1979). Georgia at the end of XI century and at the first quarter of XII Century. *Chronicles of Georgian History*. [sak'art'velo XI saukunis bolos da XII saukunis pirvel meot'xedši. sak'art'velos istoriis narkvevebi]. III. (pp. 227, 226, 9, 178,11,161-187,228). Tbilisi.

- Margishvili, S. (2006). Myths and Reality about the Reign of David the Builder. The War against Selchuk World. [mit'ebi da realoba davit' a mašeneblis mep'obis šesaxeb. Omi selč'ukt'a samqaros cinaa mdeg]. (p.98). Tbilisi.
- Meskhia, Sh. (1972). Glorious Victory. [žlevay sakvirveli]. Tbilisi.
- Metreveli, R. (1990). David the Builder. [davit' a gmašenebeli]. (p. 178) Tbilisi.
- Murghulia, M. P. Shusharin, V. P. (1998). The Polovtsi, the Georgians and Hungary in 12-13 cc.[Polovtsi, Gruzia i Vengria v 12-13 vv.] pp. 13, 62, 63, 72, 76, 150, 123, 95, 96, 215, 134, 83, 84, 100, 101.
- Nizamu'l-Mulk. (1999); Siyaset-name. Hazirlayan Prof. Dr. M.S. Koymen; Ankara. (pp 72-73).
- Orbeliani, Stepanos. *Life of Orbelians*. [c'xovreba orbeliants'a]. Old Tsartuli Translation.Georgian-Armenian sources prepared for publishing, preface and index added by Tsagareishvili, E. Tbilisi.; *Life of Kartli II*. (1959). Text is stated according to all basic manuscript by Kaukhchishvili, S. (p. 46). Tbilisi.
- P.B. Golden. (1984); *Cumanica I: The Qipcaqs in Georgia- Archivum Eurasiae Midei Aevi*, III. p. 64
- Shaishmelashvili, I. (1973). The Didgori Battle from the View Point of Military Art. [didgoris bržola samxedro xelovnebis t'valt'axedvit']. Chkhatarashvili, K., Shaishmelashvili, I. *Didgori Battle. [didgoris bržola]*. (pp. 53, 59). Tbilisi.
- Silagadze, B. (1987); Arabian Writer about Kipchaks' attack in Transcaucasia in the beginning of 20-ies of XIII century. *Georgian Source Studies*, VII. (pp. 148-151). Tbilisi. [arabi mcerali qivč'a g't'a šemosevis šesaxeb amierkavkasiaši XIII saukunis 20-iani clebis dasacqis ši. Q'art'uli cqarot'mc'odneoba, VII]. Tbilisi.
- Stepnadze, J. (1971). History and Eulogy of the Monarch. For the defining of one place. *Georgian Source Studies*, III. [istoriani da azmani šaravantedtanit'ani. Q'art'uli cqarot'mc'odneoba]. Tbilisi.
- Stepnadze, J. (1999). The King of Kings Giorgi the III. [mep'et'-mep'e giorgi III]. Second Edition. (pp. 219; 207). Tbilisi.
- Tsurtsunia, M. (2012). Ivane Javakhishvili Tbilisi State University Faculty of Humanities. Institute of Georgian History Proceedings VI. *Towards the Qipchaq (Cuman) Question in Georgian Policy of the Early 12th Century*. [qivchaqt'a sakit'xisat'vis XII saukunis kart'ul politikaši]. Tbilisi: Meridiani.
- Unusov, A. (2000). Meskh Turks Twice Deported People. [mesxetinskie turki dvaždi deportirovanni narod]. (p. 32). Baku.
- Vardan. (2002). *The World History*. [msop'lio istoria]. Translated from old Armenian by Shoshiashvili, M. & Kvatchantiradze, E. Comments and index added by Kvatchantiradze, E. (p.142). Tbilisi.

აქემენიდები საქართველოში – „ქართველთა ცხოვრების“ მიხედვით

სანაძე მანანა

საქართველოს უნივერსიტეტი

„ქართველთა ცხოვრების“ იმ ინფორმაციების ანალიზს, რომლებიც ქართლში მეფობის დაწყებამდე და ფარნავაზის გამეფებამდე ხანაზე მოგვითხრობენ, შემდეგ დასკვნებამდე მივყევართ: ძვ. წ. VII-IV სს-ში, უფრო ზუსტად ალექსანდრე მაკედონელის მიერ აქემენიანთა იმპერიის დანგრევამდე, სამხრეთ კავკასიაში ერთმანეთს იქ დამკვიდრებული სკვითური მომთაბარე ტომები და აქემენიანები ებრძოდნენ. სამხრეთ კავკასიაში და მათ შორის საქართველოს ტერიტორიაზე დამკვიდრებული სკვითები ორ ნაწილად იყოფოდნენ: თავდაპირველად მოსულები და დამკვიდრებულები, რომლებსაც „ქართველთა ცხოვრება“ „ბუნ-თურქებს“ და „ხაზარებს“ უწოდებს და მოგვიანებით, უკვე მიდიის მეფის ქიასარისაგან გამოდევნილები და თავიანთ ძველ თანამეტომეებს შემოერთებული – „თურქები“ და „ხონები“. სკვითებს ადგილობრივ კავკასიურ, მათ შორის ქართულ მოსახლეობასთან ლოიალური დამოკიდებულება ჰქონდათ, მით უფრო, რომ ერთად ლაშქრობდნენ საერთო მტრის – აქემენიანთა სპარსეთის წინააღმდეგ. სკვითები სერიოზულ პრობლემებს უქმნიდნენ აქემენიანებს, კავკასიურ ტომებთან ერთად არბევდნენ და მარცვავდნენ აქემენიანთა ჩრდილოეთ პროვინციებს. ამიტომ ეს უკანასკნელნი მაქსიმალურად ცდილობდნენ მტკვრის ხეობაში გაბატონებას და სკვითებისათვის ჩრდილოეთიდან სამხრეთ კავკასიაში შემოსასვლელი გზების ჩაკეტვას. პირველი აქემენიანი შაჰის კიროსის ლაშქრობა ამ მხრივ უშედეგო აღმოჩნდა - ის დაიღუპა სკვითურ-კავკასიურ ერთობასთან ბრძოლაში. ეს ამბავი „ქართველთა ცხოვრების“ შესავალ ნაწილში თარგამოსიანთა ნებროთთან ბრძოლის, მისი დამარცხებისა და ნებროთის მოკვლის გაბიბლიურებული ვერსიის სახითაა მოთხრობილი. აქემენიანთა რიგით მესამე ხელმწიფე დარიოს I, „ქართველთა ცხოვრების“ „სპანდიატ რვალი, ძე ვაშტასაბისა“, კვლავაც შეეცადა სკვითებისა და კავკასიელების დამარცხებას, მაგრამ მისი მცდელობა, საკუთრივ სპარსეთში აჯანყების გამო უშედეგოდ დამთავრდა. აქემენიანებმა ქართლის და ზოგადად სამხრეთ კავკასიის დამორჩილება მხოლოდ

მისი ვაჟის ქსერქსეს („ქართველთა ცხოვრების” ბარამის) და შვილიშვილის არტაქსერქსეს („ქართველთა ცხოვრების” - „რომელსაც იცნობდნენ არდაშირობით”) დროს მოახერხეს, მათ მიერ გამოგზავნილი სატრაპი არდამი იგივე არიან ქართლიდან მოსული აზოა, რომელიც არტაქსერქსეს მმიშვილი და მის მიერ მოკლული ძმის - დარიოსის (იარედი) მითიზირებული სახეა. აზო/არდამის ჩათვლით ქართლში ერთმანეთის მიყოლებით 5 აქემენიანი სატრაპი განაგებდა. აქემენიანთა გამგებლობა აქ დაახლოებით 130 წელი, ალექსანდრე მაკედონელის მიერ სპარსეთის დამარცხებამდე, ანუ 331 წლამდე გრძელდებოდა. ფარნავაზი ქსერქსე/არტაქსერქსეს ხანაში არდამ/აზოს მიერ მოკლული „ბუნ-თურქთა” მამასახლისის საგვარეულოს შთამომავალია, ანუ გაქართულებული სკვითური საგვარეულოს წარმომადგენელია, რომლის მმართველობა ალექსანდრე მაკედონელის მიერ აქემენიანთა განადგურების შემდეგ, ან ცოტა ადრე ჩაენაცვლა ქართლში აქემენიანთა მმართველობას.

The Achaemenids in Georgia According to The Georgian Chronicle

*Sanadze Manana
The University of Georgia*

The Georgian Chronicle (Kartvelta Tskhovreba) gives the following account of events in Georgia before the beginning of the Kings’ rule, or the prehistoric period:

- The settlement of the House of Targamos a.k.a. Torgoma in the South Caucasus;
- Targamos’s clash with Nebroth and his victory over Nebroth;
- The campaign against the K’hazars in North Caucasus and the building of a Citadel there;
- The conquest of Kartli by the K’hazars’;
- The establishment of the Persians’ rule in Kartli by the Persian king Afridon’s warlord (eristavi) Ardam;
- The liberation of the Georgians from the Persians;
- Another imposition of a tribute on Kartli by the Persian king Kekapos;

- Second-time liberation of the Georgians from the Persians;
- Persian King Faraborot's (Fraorta) raid into Georgia and his defeat by the locals;
- Persian King Qaikhosro's (Kiahksaros) invasion of Georgia and the subjugation of the Georgians;
- Third-time liberation of the Georgians from the Persians;
- The appearance of the 'Turks' and their settlement in Georgia by permission of the Kartli's Landlord (Mamasaxlisi);
- The arrival to Georgia of the Jewish refugees fleeing Nabucco;
- Spandiat's, the son of Persian king Vashtashab's, raid into Georgia, and his retreat soon after;
- The raid by Baram, the son of the Persian King Spandiat, and the submission of the Georgians;
- Alexander the Great's raid to Georgia and the appointment of Azo as a ruler here.

If we take a close look at the sequence of this narrative, it is obvious that by "Khazar's campaign" *The Georgian Chronicle* does not mean invasions of Georgia by the Turkic-speaking semi-nomadic K'hazars, who lived in the North of Caucasus in the VII-Xth centuries AD. In this case, the ethnonym 'K'hazar' is a term-symbol denoting only a range of nomadic tribes and thus revealing that the author of this part of the text should have lived in the VIII century (Sanadze, Beradze, 1999. p. 100). But what nomadic tribes and what occurrences are referred to in *The Georgian Chronicle*? Surely, they are the tribes who had invaded through Derbent and the Dar'ial passes before Alexander the Great, before the rulers of Persia, and before the Median Kings. This could only be the Cimmerians and the Scythian nomads at that time. In fact, the historiography points out that in various historical epochs presented in *The Georgian Chronicle* the ethnonym "K'hazar" has been used to denote the following meanings: In the most ancient times of Alexander the Great, and in the pre-Pharnavazian period, K'hazars meant nomadic Cimmerians and Scythes; in the times of Mirian and Vakhtang Gorgasali, the term meant nomadic tribes of the Huns; and in the Chronicles of VIII century, it meant the actual K'hazars, as well as north Caucasian tribes under their domination (Barkradze, 1889, p. 45; Baratov, 1865, p. 10-11; Kovalevskaia, 1875, p. 62).

But what is the real chronology of the above mentioned events? The beginning of the Raids of the Cimmerians and then of the Scythians into the South Caucasus are dated by the 30s of the VIII century BC. So, the story of the clash between the K'hazars and the Targamosians and the subjugation of the latter can be dated similarly by that time. As for the rule of the Median kings Kekapos (Keikaus), Fharaborot (Fraorta according to Herodotus), and Qaixosro (or Qiaxsar, approximately 625-585 BC), it is dated by VII-VI centuries BC. In 653/2, Fharaborot is defeated by the

Scythians and is killed in the battle.. That is the story told by *The Georgian Chronicle* about Fharaborot's raid "over the Armenians, Georgians and Targamosians:" "... [A]nd Gathered all the Targamosians, met (Fharaborot) placed near Adarbadagan, and turned him back (or repulsed) (Fharaborot) and eliminated his army."

The King of Media Qiaxsar (or Qaixosro, according to *The Georgian Chronicle*) destroyed the Urartu kingdom in 590 BC. He also successfully defeated the Scythian nomads at Media's north-western borders. Herodotus tells us how Qiaxsar eliminated the Scythians from this land and how the Scythians found a shelter in the kingdom of Lydia (Herodotus, 1975. pp. 62, 76). But Qiaxsar raided Lydia several times, and it seems that the Scythians had to move to the North-East and came in to the South Caucasus. One of the versions of this is the information found in *The Georgian Chronicle* that tells us about the "Turks" that fled from Qaixosro (Qiaxsar) and came to Georgia. Evidently, *Turks* here is the term-symbol used to denote the nomadic tribes in general (just like that of *K'hazars*): "It was the time when the Turks fled from Qaixosro, passed over the Gourgen Sea (Caspian Sea), went up the river Mtkvari and came to Mtskheta; and they were 28 houses that asked the Mamasaxlisi (Landlord) of Mtskheta..." (*The Georgian Chronicle*, 1955, p. 15).

The "Gourgen Sea" is, evidently, the Caspian Sea and is interpolated in the text in the VIth century AD, as at that time the Persians already fought against the real Turks and not the Scythian nomads, and not in Asia Minor or Lydia, but in Central Asia, at the banks of Amu-Darya. Thus, the Georgian chronicler thought that the only route that the Turks could take to get to Kartli could have been via the Caspian Sea. The same story, with some minor differences, is told in *The Conversion of Georgia (Moktsevai Kartlisa)*: "Then came warrior tribes of the Hons, pursued by the Chaldeans, and beseeched the Lord of the Bun-Turks (Native Turks) to give them a land for rent (in Georgian, kharky), and settled at Zanavi place. And they Kept it For rent (kharky) and this [was] why the name of the place became kherky" (*Moktsevai Kartlisa*, 1961, p. 81).

The similarity of these two references becomes even clearer, if we take into account that in the old Georgian "Chaldean" meant "Persian," and Hons/Huns as well as Turks and K'hazars meant nomads in general, or – in the times of Qiaxsar/Qaixosro – the Scythians in particular. In *The Conversion of Georgia*, the Mamasaxlisi of Mtskheta is mentioned as the Lord of Bun-Turks because according to this source, before the coming to Georgia of Alexander the Great, it had been actually inhabited by the mixed Georgian-Cimmerian or Georgian-Scythian population: "[D]own the river Mtkvari in four cities." Thus, according to this source, when the Hones (i.e. Scythians), fled from the Medians//Chaldeans and came to Georgia, they were met here by the Georgian-Scythian population, named as the Bun-Turks (Native Turks).

In the text of *The Conversion of Georgia*, later the above mentioned term “Chaldeans” was later interpreted by one of its editors, in whose time this ethnonym already did not mean the Persians; this interpreter considered Chaldeans as the Mesopotamian population and linked the fact of the “Hons” retreat from this region to the name of king Nebuchadnezzar, who was notorious for his policy of dispersal and resettlement. Such interpretation is even more plausible, if we take into account the fact that at that times (VIII-IX cc.) nobody remembered the Hon/Huns. That is why the historian of a later period thought that “Hons” was an abbreviation and decoded it as “Hurians,” or “Jews” (Arakhamia, 2002, pp. 126-128).). That was the reason why the information was distorted: “King Nebuchadnezzar destroyed Jerusalem and the Hurians (actually, the Hones/Huns) fled to come to Kartli and asked the Mamasaxlisi of Mtskheta a land for settling and promised to pay rent (in Georgian, kharky). He gave them the place to live on the bank of the Aragvi River, named Zanavi. And they kept it for rent (kharky) and this why the name of the place became kherky.”

The same story about how the Scythian nomads fled from Qaixosro/Qiaxsar and appeared in South Caucasus is told in *The Georgian Chronicle* as one more Biblically veiled version. Like many other nations, after the conversion to Christianity, the Georgians tried to attach their mythical heroes to “biblical” prototypes. The opening part of *The Georgian Chronicle* tells us about the settling of Targamos in South Caucasus, his struggle with Nimrod and his defeat. When in the XXth century, the Georgian historiography started critical analysis of *The Georgian Chronicle*, this opening part was claimed to be a Biblical scheme only, lacking historical evidence; but in fact, it is a biblical redesigning of the historical information (Sanadze, 2001, p. 29).

Names of the Ethnarchs Torgoma and Gomer derive from the same root Cimer. Namely, Gomer is the Biblical form of Cimer, i.e. Cimmerian. Why did ancient *The Georgian Chronicle* attach the story of the Scythians, who fled from Qiaxsar, to Togorma/Targamos and why did he tell all this in the form of a narrative of the Targamosians’ arrival? This is because he considered Targamos as the ancestor for nomadic tribes in general, as well as for the Scythians. Thus, the story of the arrival of the Targamosians to South Caucasus is the Biblically veiled version of these stories: the coming of the “Hons pursued by the Chaldeans” from *The Conversion of Georgia*, the arrival of the “Turks [who] fled from Qaixosro” from *The Georgian Chronicle*, and the flight of the Scythians from Qiaxsar the king of Media from Herodotus. We can precisely determine the chronology of this historical event: it should have happened between years 590-585, as a period when the king of Media – Qiaxsar destroyed Urartu, and his death.

Now let us consider the story how the Targamosian brothers, i.e. Scythians and Caucasian joint forces struggled against Nimrod (Nebroth), defeated him, killed him and liberated Caucasian tribes from the Nimrodians.

This Nimrod, like Targamos, is a biblical personage. According to the Holy Book, Nimrod is the son of Cush - one of the Noah's grandsons. He was the king of Mesopotamia, the king of Shinkari country, and he became notorious for his forceful policy towards other nations. That is why in South Caucasian folk epic, he was identified with the oppressor and enslaver against whom the house of Torgoma, i.e. Georgian-Armenian-Scythian union fights successfully. According to Armenian sources, the name of the giant enemy of the Torgoma house is Bel - also one of the legendary kings of Mesopotamia. The Armenian historian Movses Khorenatsi notes that Bel is Nimrod himself. So, we can conclude that he is acquainted with the Georgian version of the story from *The Georgian Chronicle*. But actually, who stands for Armenian Bel and biblical Nimrod or Nebroth from *The Georgian Chronicle*?

In *The Georgians Chronicle*, Nimrod (Nebroth) is forefather of the Persians: "And since then strengthened the Persians living in the East, where the Sun rises, descended from Nimrod," says the chronicler. The "Book of Nimrod" is well-known to the authors of *The Georgian Chronicle*, and evidently it the same as the great Persian-Zoroastrian book - the Avesta. In the same *Chronicle*, in the context of Persian dynasties, the Nebrothians means the Achaemenids as well as the Ajghalanians means the Arshakians of Parthia and the Khosroians means the Sassanides.

According to *The Georgian Chronicle*, Nebroth/Nimrod is the ruler of the world: "*All these eight [the Targamosian brothers] served Nimrod the Hero, who was the king of the whole world,*" says the chronicler. The first Achaemenian king of Persia, the Ruler of the World, Nebroth assaults the Targamosians (according to the chronicler's terminology), in fact the Scythian-Caucasian joint army near Ardabagadan, that is, from the side of present-day Iranian Azerbaijan: "*...and as came Nebroth to the land of Adarbagadan and camped there,*" continues the chronicler. Finally, the decisive battle will take place near the Mount Ararat, in broad valley: "*... And Haos called for all seven heroes and all the Targamos keens and got aid from other relatives from the West. He gathered them all at the base of the Mount Masis.*" The Targamosians take over and the first king (the forefather) of the Persians perishes in the battle with the Targamosians, that is, the Georgian-Caucasian-Scythian union. Definitely, it is nothing but a biblical view of the folk story that transforms an event well-known through the ancient world about the killing of Cyrus (Kiros), the first king of the Persia, in the battle with the Scythians near the Araxes river (Sanadze, 2008, p. 257). This great battle, most completely described in *The History* of Herodotus, can be dated quite exactly by the death of Cyrus in 530 BC.

Nowadays, in the modern historiography, this battle is considered to have taken place near the river Amu-Darya, but as we have already proved, this argument is based on a wrongful understanding of Herodotus' geography: In fact, Herodotus meant river Araxes in the south Caucasus and not Amu-Darya in Central Asia as the place where the Scythians killed Cyrus (Sanadze, 2008, p. 257).

After telling in a mythical-biblical form (as a fight of the Targamosians with Nimrod) the story of the defeat and death of Cyrus by the Georgian-Armenian-Caucasian-Scythian tribes, the chronicler of *The Georgian Chronicle* makes a long chronological leap backwards, into the depths of centuries, and recalls the events of the Median kings – Kekapos (Qeiqaus), Fharaborot (Fraorta), and Qaixosro/Qiaxsar: Their raids into the South Caucasian region and namely, into the territory of Georgia. But before starting the cycle about these historical median kings, he speaks of legendary Persian king Aphridon, who raided South Caucasus and whose sons fought among themselves for the throne. He also mentions that in the times of king Aphridon, a Persian warlord (“eristavi”) Ardam came to Kartli and settled there.

The latest dating margin for the Median kings mentioned in *The Georgian Chronicle* is Qiaxsar/Qaixosro's deathtime in 585 BC.

Then the story tells about the Persian king Vashtashab's son, Spandiat Rvali, raiding Kartli and retreating soon, thanks to internal disturbances that took place in Persia. This undoubtedly is the ruler, Darius I (522-486 BC), the son of Histaspas/Hishtashba/Vishtashpa, that actually raided Armenia, and supposedly, Kartli as well. At that time, Darius I failed to suppress the rebels, as someone Gaumata the Magus raised a large-scale rebellion in Persia proper. These events are dated by the year 522 BC. Then, *The Georgian Chronicle* makes one more long chronological leap of some sixty years, but this time forward, and does not say anything about the rule of the first Achaemenid kings – Cyrus II (Kiros II) and Cambis II (as we have seen, the fight of Cyrus with the Georgian-Scythian-Caucasian union was told in an epical-mythical form as the struggle of the Targamosians against Nimrod) but speaks directly about the events that imply relations of the third king, Darius I, with the South Caucasians.

The Georgian Chronicle concludes the so-called “Persian Cycle” with following information: “Afterwards, for several years, Baram, the son of Spandia, who was known under the name of Ardashir, became the king of Persia. His fame surpassed that of any other Persian kings and he conquered Babel and Assyria, and laid commission upon the Greeks and Romans and on Georgians as well.”

In this case, the information covers all in one: That of the two kings of Persia – the son of Darius I, Xerxes - Baram from *The Georgian Chronicle* and the grandson of Darius I, Artaxerxes. Artaxerxes is only mentioned in some sources by the name of *Ardashir*. From the beginning of Xerxes'

rule, the Achaemenid Persia became unprecedentedly successful. In 480 BC, Xerxes started a war against the Greeks and occupied the most of Thrace and Greece. No other Achaemenid rulers were ever so successful in the Western (European) direction. The King Leonydas of Sparta was defeated and killed and the Persians seized the most important city-state of ancient Greece, Athens. Although, finally the scale of success tilted in favor of the Greeks and Persia lost that war.

The success of Xerxes in Mesopotamia was equally significant: In 479 BC, he finally abolished the kingdom of Babel (until then, the title of the kings of Babel belonged to the Achaemenids personally) and made Babel one of the provinces of Persia. Let's recall the phrase from *The Georgian Chronicle*: "He conquered Babel and Assyria, and laid a tribute upon the Greeks and the Romans."

As we see, that is the same time when, according to *The Georgian Chronicle*, Xerxes/Baram also laid a tribute on Kartli. At that time, he was content with the contribution, and never sent a Persian satrap to Kartli. Such policy was taken only by his son, Artaxerxes/Ardashir.

In fact, this Artaxerxes-Ardashir (462-424 BC) was not a legal heir to the throne: He was enthroned thanks to a conspiracy against his father and his elder brother Darius in 465 BC, and after their murder, he himself got rid of the other of his brothers, Vishtaspa. *The Georgian Chronicle* considers Xerxes/Abram and his son, Artaxerxes/Ardashir as one and the same person, and it connects the reign of this "dual" king with the period when the Achaemenids rule was finally established in Georgia. After telling us about the fact of imposition of a tribute on Kartli, the *Georgian Chronicle* turns on to Alexander the Great's invasion of Georgia, thus chronologically jumping to the years 330-323 BC and omitting a 130-year period, although it is obvious that during the time of Artaxerxes/Ardashir's rule and the era of Alexander the Great, the Achaemenids were in power here.

Now let's turn to the question of the king Aphridon's epoch, Kartli's tribute, and the Persian satrap Ardam's coming to Georgia. As *The Georgian Chronicle* considers strengthening of the Persians in the South Caucasus at the time of Artaxerxes/Ardashir to be a later fact, it names Aphridon – the legendary king of Persia – as the first to come and conquer Kartli.

The Georgian Chronicle on the levying of a tribute on Kartli in the times of Aphridon:

And since then strengthened the Persians in the East – descendent of Nimrod, and one hero amongst them, named Aphridon, 'who chained the Lord of Serpents – Bevrasph, and tied him at the mountain where no man can find a path.' This is written in the "Persian Chronicle". Aphridon ruled over entire Persia, and sent to

some of its parts warlords (eristavi) of his own, and made some to pay him a contribution. He sent his warlord (eristavi) Ardam, son of Nimrod's descendents, with an enormous army, and he came to Kartli and ruined all the cities and citadels and killed all of K'hazars found in Kartli. (*The Georgian Chronicle*, 1955, p. 13)

The Georgian Chronicle on the levying of a tribute on Kartle at the time of Xerxes/Baram and Artaxerxes/Ardashir:

Several years after this, the son of Spandiat, named Baram, known as Ardashir, became the king of Persia. He became the greatest amongst of the kings of Persia. He conquered Babylon and Assyria, laid a contribution upon the Greeks and the Romans, and the Georgians as well. (*The Georgian Chronicle*, 1955, p. 16).

It seems there is nothing to be surprised about: There are centuries between these two events, but the anachronistic layout is quite clear – it is one more example, as it was in case of Nimrod and Torgamos, that history and myth are mixed up. Aphridon, the same Phridon, is a mythical king of Persia, and so, what epoch and which historical king is meant under his name in *The Georgian Chronicle*? It is hard to suppose that the Persians could have invaded South Caucasus and appointed their own ruler there before the abovementioned Kaikhosro/Qiaxisar for the simple reason that Media itself had not yet been established as an united kingdom. Qeiqavus' and Phraortes' activities, according to the chronicler of *The Georgian Chronicle*, were of no particular success; and it is hard to imagine it could have happened in an even earlier period, in the time of the legendary Aphridon. Before Kaikhosro / Qiaxisar, mostly the Scythians and the Urartian Kingdom dominated in South Caucasus. Qiaxisar destroyed Urartu only in the year 590 BC, and at that same time, he did a lot of damage to the Scythians as well, and afterwards, as we already mentioned, their big masses came back to South Caucasus and settled there. If all this had happened before Qiaxisar, warlord (eristavi) Ardam could not have found Khazars, that is, the Scythians on the territory of Georgia, because before the new influx of the Scythians driven out by Qiaxisar, the part of the Scythians who had invaded the South Caucasus and, which had detached from the main influx and stayed on the territory of Georgia almost two centuries before had already assimilated with locals.

Thus, we can suppose that Ardam, the same Satrap who came to Kartli in the time of the Achaemenids, and not in the period when the mythical Aphridon reigned. As for the levying of a tribute on Kartli in the times of the Achaemenids, *The Georgian Chronicle* connects this fact with the reign of Xerxes (Baram)-Ardashir (Artaxerxes). The same source offers us an interesting report about the ruling period of eristavs - satraps

in Kartli: According to the chronicler, there were five “eristavs” succeeding each other in Kartli including Ardam himself. Their rule was hereditary and the five eristavis ruled in Kartli for approximately 125-130 years. If we take as the starting point the year 331 BC, when Alexander the Great defeated Persia’s last ruler Darius III, and make a countdown, we’ll get the year 460 BC, that is, the beginning of Artaxerxes/Ardashir’s reign (462 BC.). In fact, that is the sum of those years that the chronicler missed out when he jumped right to Alexander the Great, after the period of Artaxerxes/Ardashir. Moreover, all this story about the struggle between the three sons of Aphridon for the throne, when the elder brother and legal heir, *Yared*, perished, is absolutely identical to the story of Artaxerxes’ ascending to throne and the death of his elder brother *Dari*. All this proves that Aphridon mentioned in *The Georgian Chronicle* is a mythical prototype of the fourth Achaemenid king, Xerxes/Baram (Sanadze, 2010).

In its pre-Pharnavazian part, *The Georgian Chronicle* often presents one and the same story in two versions: that of a mythical epic and a historical document. The reason is that the chronicler refused to miss any information, be it Georgian mythical, written or any foreign (Persian-Aramaic, Greek) sources. Because of some differences between these various versions of the same historical story, chronicler suggests them to be different stories and puts them in temporal sequence. This doubles, or sometimes, even triples the ancient stories; and sometimes even makes them chronologically vague.

Now we must pay special interest to the subject of identifying Azo and Alexander the Great in Georgian sources. According to *The Georgian Chronicle* and *The Conversion of Georgia*, Alexander the Great might have raided Georgia twice. *The Conversion of Georgia* describes the first raid of Alexander the Great into Georgia as follows:

Firstly, when Alexander the Great defeated the Loti tribe sons and sent to land of Kedari (land of north) came up the river Mtkvari and saw brutal Bun-Turks [native Turks] living in four towns: Sarkine, Kaspi, Urbnisi and Ozrkhe; and their castles: great castle of Sarkine, Uphlistsikhe of Kaspi, and the citadels of Urbnisi and Ozrkhe. Alexander was surprised to see that they were kin to Yebosians, used to eat any flesh and had no graves, as they ate their dead. Alexander could not fight them and retreated.

Then came warrior tribes of the Hons, fleeing the Chaldeans, and beseeched the Lord of the Bun-Turks [Native Turks] to give them a land for rent (in Georgian, kharky), and settled at Zanavi place. And they kept it for rent (kharky) and this why the name of the place became kherky.

The second raid of Alexander the Great to Georgia is described as follows:

Some time after, again came Alexander, the lord of the world, and ruined three of these towns and citadels, and defeated Huns. And put under siege the town of Sarkine for eleven months and stopped in the west of Sarkine, planted the vineyard, channeled out the water from river Ksani, put there watchmen (dastagi) and this why this place was called Nastakisi. He took the town Sarkine and they (Turks of Sarkine) abandoned town and fled. (5, 81).

The Georgian Chronicle describes the first raid of Alexander the Great into Georgia as follows:

Alexander conquered the whole world... [c]ame over the mountains of Caucasus and came to Kartli, and found the Georgians worse than any in their faith, having no limit in vice and marriage, eating their dead, and most cruel in behavior, similar to beasts. The behavior of whom was unable to utter. Pagans and barbarians they were, whom we call the Bun-Turks and Kipchaks, and lived on the banks of the River Mtkvari. Alexander tried to defeat them, but failed, as high were the walls of citadels, and mighty[were] the warriors.

Later came other tribes of the Chaldeans and settled in Kartli too.

Alexander's second raid into Georgia is described as follows:

[A]nd became Alexander the lord of the world, and he came to Kartli, and found strongholds and citadels there: Tsunda, Khertvisi of Mtkvari, Odzrkhe on the rock of Ghado, Tukharisi overlooking the river Speri, named Chorokhi, Urbnisi, Kaspi, and Uphlistsikhe; Big town of Mskheta and its surroundings: Sarkine, Tsikhedidi, Zanavi – Jewish district, Rustavi, main citadel of Samshvilde and citadel of Mtveri – named Khunan and towns in Kakheti. And locals were well-armed and fighting brutally. Then he divided his army and put all these towns under siege, and himself he set near Mtskheta, and strengthened with the army: that side and this side (benches of river Mtkvari), up and down, and he himself stood near the river Ksani, at the place called Nastakisi.

However, he did not fight against the citadel of Mtveri and Tukharisi, as they were too well-built. He conquered all the citadels and cities in six months. The Bun-Turks of Sarkine scolded him, and Alexander got angry, and refused to make a treaty with them... He fought with the Sarkine people for 11 months. They

secretly started to make a hole in the rock and finally bored it. .. They left the town empty. Thus conquered Alexander all of the land of Kartli and annihilated all the mixed population there, took women and those under 15 years old captive and only spared the descendent of the Kartlosians. (4, 18)

The similarity of these texts is self-evident, but it is clear that the same story is told in different volumes and details, though the first coming of Alexander is almost identical in both Chronicles. The main plot of the texts stresses the fact that Alexander invaded Georgia and was met by the Scythians, who are named the Bun-Turks or the "local Turks" by the author of *The Conversion of Georgia* and as Bun-Turks and Kipchaks in *The Georgian Chronicle*. No wonder that Kipchaks in *The Georgian Chronicle* should have appeared in the XII century, when the Georgians got acquainted with the nomadic Kipchaks. It is noteworthy that *The Georgian Chronicle* identifies these Bun-Turks, that is the Scythians, with Georgians too: "... and found the Georgians worse than any in their faith, pagans and barbarians they were, who we call the Bun-Turks and Kipchaks...," says the chronicler. It is quite clear that from his point of view, the Scythians or the Bun-Turks and the Georgians are some organic unity. Both chronicles agree that Alexander's first raid was a failure; he could not seize the citadels/towns and had to retreat.

After this, both chronicles tell us about some people coming to Georgia. *The Conversion of Georgia* identifies them with the Huns that fled from the Chaldeans, that is, the Persians, and for *The Georgian Chronicle*, they are merely the Chaldeans that came to Kartli and settled there. This also is no surprise as the chronicler of *The Georgian Chronicle* turned the story of the "Huns, who fled from the Chaldeans" and their settling in Georgia into the story of Hurias (Jews) that fled from Mesopotamian ruler Nebuchadnezzar and settled here in Georgia. So the chronicler settled the Jews instead of the Huns (i.e. the Scythians) in Kherk and Zanavi. Therefore, it would have been strange of him to settle them in the same places for the second time!

Afterwards, both of the texts tell us about the second raid of Alexander the Great to Georgia. Describing this event, "The Georgian Chronicle's" is more voluminous than the "Conversion of Georgia", but on the whole, the information is identical: Alexander defeated Scythians, i. e. the Huns –the same Bun-Turks, so that they had to flee from Georgia and moved to North Caucasus.

Finally, both Chronicals give us the same kind of information – namely, about how Alexander brought a certain Azon/Azo to Georgia and made him a ruler there. Though, facts about the descent and identity of Azo are radically different in these sources.

The Georgian Chronicle outlines the facts as follows:

... And he left Azon, the son of Yaredos, descendent of the Macedonians, as a governor (Patric) over them and gave him 100,000 Protathosian soldiers from the Romans. These Protathosian were strong men stragglng against the Romans and he brought them to Kartli, gave them to Governor (Patric) Azon, appointed the latter as the Eristavi of Kartli and left him with his soldiers there. (4, 18)

The Conversion of Georgia presents the following account:

Alexander the King had beside him Azo, son of king from Arian-Kartli and gave him Mtskheta to rule over, and the borders up to Hereti, Egrisi River, Somkhiti, and mountain Tsroli, and left. (5, 18)

The information of *The Georgian Chronicle* can be described as layers of events that took place in different historical periods: This is where Alexander the Great coexists with a hundred thousand Roman soldiers; but the Romans appeared in South Caucasus and in Georgia proper in 65 BC, when this region was raided by the famous Roman general Pompeius. Definitely, the Romans had nothing to do with Alexander the Great, as well as with Azo (see below). So, where did these 100,000 horsemen, which were afterwards considered the Romans, come from? While speaking about Azo's coming to Kartli, *The Conversion of Georgia* mentions "eight houses and ten houses of mama-mdzudze" accompanying him. The term "house" here has nothing to do with modern "household" but means "tribe." In comparison, the "mamamdzuze" (straight meaning of it being "father-breast giver," "wet nurse") meant a tribe of lower social status. Different versions of the same plot are given in other Georgian sources. The changes mainly refer to the number and social terminology. For example, there are mentioned *ten* and *ten*, as well as *thousand* and *ten*. E. g., in the XI-XII cc. editions of *the Life of St. Nino*, we read: "Then Azoel went to Kartli and took thousand houses of laymen and ten houses of noblemen, with all their relatives with him, and settled them there." As we see, the original *eight and ten* gradually transformed into *thousand and ten*, and in the later edition of *The Georgian Chronicle* even into *hundred thousand* Roman soldiers.

Other information about Azo, given in *The Georgian Chronicle* is evidently changed in the later times. Precisely, they show some trace of Hellenization: Azo is transformed into "Azon," that is, Jason and his father's name, Yared-os also carries a Greek suffix. However, most importantly, Azon/Jason himself becomes a Macedonian general and thus a comrade of Alexander. All this proves the priority of the version kept in *The Con-*

version of Georgia. Nevertheless, who was Azo and how could he be related to Alexander the Great? Besides all these, did Alexander the Great really raid Georgia?

Nowadays scientists generally agree that Alexander the Great had never been to Georgia (Sanadze, 2001, pp. 70-72).

Nevertheless, an ancient *The Georgian Chronicler* had a basis for bringing Alexander the Great to Kartli. Firstly, it is the antique Greco-Roman literary heritage, where Alexander's raids into "Pontus" or "Caucasus of the Scythians" are mentioned in different passages. It should be noted that in the ancient times two Caucasus existed: One was the Scythian Caucasus, that is, on the Black Sea coast, and the other was the Indian Caucasus, that of the Hindu Kush. One group of ancient authors confused the Hindu Kush and the Scythian Caucasus (the same as our Caucasus) with each other. Thus, Alexander's raid to India and crossing of the Hindu Kush was mistaken as a raid into the Black Sea region. Such a mistake was especially common for the Roman authors who were rather far chronologically from the times of Alexander and had little knowledge about the Indian Caucasus, but who knew quite well the "Caucasian" Caucasus. This mistake was corrected by the ancient Greeks, who criticized the fact of the turning of the Hindu Kush Caucasus into the Caucasian Caucasus. Thus, the ancient Georgian historian, in this particular case Juansher Juansheriani, could have encountered such stories in the writings of antique writers, both Latin and Greek, about the coming of Alexander of Macedonia to his motherland [Georgia] and raiding the Caucasus Region from the North to the South (as *The Georgian Chronicle* relates) or from the South to the North. In short, the story of Alexander of Macedonia is interpolated in the plot due to the similarity of the stories. Obviously, Juansher Juansheriani asked a question: Who could have been the anonymous "king of the whole world" from the ancient chronicles, who "ruined three citadels/towns and wiped out the Huns" and decided that it was nobody but Alexander. Now, let us try to understand who was the anonymous king whose name was replaced by Alexander the Great? Naturally, it is in some connection with the identity of Azo that in Persian stands for "Leader," or "Goat" (Andronikashvili, 1966, p. 136).

According to the Azo's very first story from *The Conversion of Georgia*, Azo's native country was Arian-Kartli. Nobody doubts that Ariani/Ariana is Iran and Persia. Arian-Kartli is supposed to be the Persian Kartli. But then opinions of scholars start to differ: The most popular viewpoint is that Arian-Kartli is identified with the Klarjeti region. This opinion is conventionally shared among the scholars. (Melikishvili, 1959, pp. 278-279; Khazaradze, 2001, pp. 331-332; Sanadze 2010). It is based on two postulates: 1. Azo comes from Klarjeti, because when the Georgians abandoned him and supported Pharnavaz, Azo flees to Klarjeti, and finds a shelter "in the citadels of Klarjeti." In the same year, the chronicler in-

forms us that Pharnavaz conquered the whole Kartli, except the Klarjeti region. Indeed, according to the same chronicler, Azo ruled Klarjeti before the final struggle with Pharnavaz, until his death in Klarjeti.

Even the last battle between Pharnavaz and Azo took place in the South-West of Georgia, in the Javakheti region. Nevertheless, this is not an incontrovertible proof of Azo's Klarjeti origin. If we assume that Azo who came from Arian-Kartli was Persian and he fought Pharnavaz in times when Persia had been already defeated by Alexander the Great, it becomes clear that the defeated motherland could no longer support Azo and the latter had to seek refuge in one of the regions that were under his own rule. Apart from that, according to Herodotus, two satrapies (the 18th and the 19th) bordered Georgia from the South-West. In such a situation for the Persian Satrap who was in Mtskheta, who is referred to as "patrik" (a Byzantine term denoting a local ruler) in *The Georgian Chronicle*, it would be the only way out to seek a refuge in Klarjeti, and wait for assistance - troops from neighboring Persian satrapies there.

And yet, for those supporting the viewpoint that Azo was a Klarjetian, the second argument is most valuable. The proponents of the viewpoint insist that Arian-Kartli, or the Persian Kartli was just a part of Georgia occupied by the Persians. According to Herodotus, such a place could only be the South-Western part of Georgia, since this is the place of residence (the mouth of the Mtkvari and the Chorokhi Basin) of the Georgian tribes: Saspers, Moskhs, Mosinics, Tibarens, etc, paying a tribute to Persia. Indeed, when Herodotus lists the countries that paid a tribute to the Achamenids and their satrapies, he remarks: "Matians, Saspers, and Alarodians paid 200 talents, and that is the 18th satrapy; Moskhs, Tibarens, Mosinics, and Marees had to pay 300 talents, and that is the 19th satrapy". (Herodotus, 1975, p. 226).

The point is that the chronicler of *The Conversion of Georgia* could not identify the abovementioned tribes as "Georgians" - even modern scholars had to conduct linguistic research for that purposes. Based on what then could the chronicler refer to the Klarjeti region or the South-Western part of Georgia on the whole, as "Persian Kartli"? This could have happened in the case of a historical tradition that the Persians conquered and ruled only in the South-Western parts of Georgia. Yet, the historical reality is different. According to *The Georgian Chronicle*, the evidence of that is based not only on written and oral sources, but to a considerable extent also on the historical tradition mentioned above: the Persians conquered the whole Kartli and their "eristavi," that is, the satrap resided in Mtskheta. In this circumstances, Arian-Kartli could not have been a term standing for Klarjeti, as the whole Kartli ruled by the Persians!

Everything will become much clearer, if we take *The Georgian Chronicle* as the basic source of information. If we cut off the Greek suffix

'os' from Azo's father's name, we will have just *Yared*. What does *The Georgian Chronicle* say about Yared?

"When Aphridon divided the kingdom between his three sons, Yared got both Persia and Kartli. Then the two brothers killed Yared, the third one" (4, 13).

As we can see, Yared, the father to Azo, was not a Macedonian general, but a Persian prince. Moreover, he is the one of the three brothers, who ruled over Persia, and also received Kartli as his share. No wonder that after Yared's death, his son Azo got away from his uncles and fled to Georgia, with all his army and household. It also might have been that his uncles gave him the mission in order to get rid of him.

Thus, we see that Yared, one of the three sons of Persian King Aphridon, was killed by his brothers; while Azo, the son of Yared, fled to faraway Georgia to conquer it; he may have been sent there by the brothers of Yared to get rid of him (or he escaped himself). Conquering the region was a very important matter for Persia because the inhabitants of South Caucasus, in alliance with the Scythians, were a trouble for the Achaemenid Persia and apparently the raids of the former [the Scythians] from the North were devastating the Persians.

The same story, according to other version is as follows:

Aphridon conquered the whole Persia, to some countries he sent *eristavis*, and some of the countries paid him contribution. He sent a great *eristavi* Ardam, the son of Nimrod's descendent, with a big army to Kartli, Ardam ruined the citadels/towns of Kartli, and killed all the Khazars there. Ardam *Eristavi* built a city and called in Derbent.that is translated as "closed door" (*daxsha kari*) He also been the first to fortify Mtskheta by limestone. After that people of Kartli learnt constructions by using Limestones. The same Ardam expanded the Armazi limestone fortification up to Mtrvari river. Aradm ruled there for many years. (4, 13).

If we replace the symbolic narration of *The Georgian Chronicle* with historical-scientific terms, we can see the following: A Persian king, conditionally referred as Aphridon, who is the mythical face of Xerxes I the Achaemenid, as we could see above, sent an *eristavi*-satrap named Ardam Achaemenid (Nimrodian) who ruined all the citadels/towns in Kartli and killed as many Khazars, i.e., the Scythians as he found in Georgia. In the times of the same Aphridon, Azo, the son of Yaredos, Aphridon's son, came to Georgia. He was notorious for his brutality. A representative of the Achaemenid dynasty, *eristavi* or satrap Ardam, also notorious for his cruelty and violence came to Georgia, too. If we take into consideration the fact that Azo is not a personal name and means "the leader" in gen-

eral, the resemblance between Azo's and Ardam's identity will not be difficult to realize.

According to both sources, *The Georgian Chronicle* and *The Conversion of Georgia*, Alexander the Great comes to Georgia twice: The first time, he failed to harm local citadels and retreated with no results; the second time, he conquered the country and ruined the foundations of citadels. In *The Georgian Chronicle*, the same story is told otherwise: 1. The coming of Spandiat, i.e. Darius, the son of Vashtashab, and his retreat because of a rebellion in homeland. 2. The levying of a tribute on Kartli in the time of his son Baram, i.e. Xerxes, a.k.a. Darius's grandson Artaxerxes/Ardashir epoch.

Now we can assume that the "king of the whole world," later called "Alexander the Great", was actually the mighty king of Persia Darius I the Achaemenid, that is, Spandiat Rvali, son of Vashtashab, who raided the South Caucasus, but because of a rebellion in Persia, had to retreat. Later on, an Achaemenid satrap named Ardam sent by Artaxerxes, the same "Azo, son of Yaredos," conquered Kartli (Azo was the son of Darius; of the elder brother of Artaxerxes and legal heir to the throne. He was assassinated by the rebels). Indeed how did the so-called Alexandre acted when he came second time in Kartli?

"So Alexandre came, the king of the entire world, and ruined these three cities and citadels, and smashed the Huns...", says the chronicler (5, 81). We can assume that he speaks about the Huns that were actually "Khazars", i.e. the Scythians.

The fact that the so-called "Alexander" is Ardam Eristavi of Achaemenids, i.e. Azo, becomes even more evident, if we compare the deeds of Azo in Georgia with the abovementioned extract that has already described Ardam the Satrap's activities in Georgia:

Azo destroyed the walls of Mtskheta with the foundation and left just four citadels: one the main citadel called Armazi, the second at the end of Armazi fortification, the third, at the top of Mtskheta and the fourth on the west, over the river Mtkvari. He strengthened and filled them with his own army, knocked down all the fortifications and conquered all the borders of Kartli from Hereti and River Berduji, till the Sea of Speri (Black Sea), and conquered Egrisi too and laid a tribute upon the Ossetians, the Lesghins, and the Khazars. (4,19)

We should also take into account that before the so-called "Alexander of Macedonia" came to Kartli, *The Georgian Chronicle* tells us about the Achaemenids setting their rule there in the times of Artaxerxes/Ardashir purging the Khazars, i.e. Scythians. If Alexander were to invade Kartli, he would have to deal with the Achaemenids and not with

the Huns and “Khazars”. But instead it is told that Alexander still eliminates the Huns and the “Bun-Turks” because the name “Alexander” substituted “Ardam” and “Achaemenids” in the text.

The Georgian Chronicle says the following about the end of the Persian eristavi-satrap approximately 130-year rule:

While the sons of Aphridon were struggling with each other and two of them killed the third brother Yared, the Kartlosians took advantage of the situation and called the Ossetians; they found the Persian satrap (eristavi) on the battle field and killed him. The Ossetians and the Georgians got rid of the Persians, and liberated Kartvelians, yet Rani and Hereti were left under the Persian rule. (4, 13-14)

Even in this case, the chronicler ignores the chronological sequence; however it is not difficult to restore the chronology: Ardam the Satrap came to Georgia right at the time when two brothers killed Azo’s father Yared; later the 130-year Achaemenian reign started: “Ardam was the eristavi for many years... and after Ardam eristavi’s death the D eristavis died” notifies *The Georgian Chronicle*. Thus, the defeat of Ardam/Azo could not coincide with the time of the killing of Yared (i.e. Dari-os, the elder son of Xerxes) and the time of Artaxerxes and his brother Vishtasp fighting for the throne. So, when were the Achaemenids, i.e. people of Ardam/Azo defeated? Which period is implied in the abovementioned information and who was the organizer of the defeat of the Achaemenids in Kartli?

According to *The Georgian Chronicle*, Azo’s defeat and the beginning of a local dynasty’s rule is connected with Pharnavaz. The name Pharnavaz is also of Persian origin and means “shining hand” or the glorious ruler. Pharnavaz/Pharnavush is one of the epithets for Ahuramazda, and in Persian realm it was used for the king, because the king was considered as the incarnation of Ahuramazda on the Earth (Sanadze, 2001, p. 82). In the kingdom of Kartli, in time of Pharnavazians’ rule, Pharnavaz/Pharnavush was a title for the kings of Kartli. Later on, it became a proper name. Therefore, Pharnavaz defeats satrap Azo – after Macedonians take over Persia – and he himself becomes the king. But actually, who is Pharnavaz? Which dynasty substitutes the Achaemenids in the South of Caucasus? According to *The Georgian Chronicle*, this Pharnavaz is a nephew to Samara, the “Mamasakhlisi” (the landlord) of Mtskheta. In addition, as we know, this Samara ruled in Kartli in the times of the so-called “Alexander’s” raid to Georgia, i.e. the Achaemenid Ardam-Azo’s occupation of Kartli, in approximately 460s BC. As we know from *The Conversion of Georgia*, the mamasakhlisi of Mtskheta of that time is the mamasakhlisi of the Bun-Turks, i.e. he is of local nomadic Georgian-Caucasian-Scythian

origin. Indeed, Pharnavaz is a nomad-hunter. He had to flee to the Caucasian highlands from the Achaemenid rule. In the period of Azo-Achaemenid rule in Kartli and the whole South Caucasus, which lasted for about 130 years, Pharnavaz developed friendly relations with the Achaemenids and gained permission from the Achaemenid governor Azo to come back and settle in Kartli. Naturally in such conditions, when Iran was destroyed, the Achaemenid satraps' dynasty, left without any support in the South Caucasus, was defeated by the Georgian-Caucasian-Scythian coalition. This was thereafter followed by the restoration of the Georgianized Scythian dynasty's rule in Kartli.

One of the versions of Azo's, i. e. Achaemenids' arrival in Kartli and establishing of their rule there can be found in the writings of a Byzantine historian Cesar Constantine Porphyrogenitus. Surely, he had heard the story from Georgians, which he never denied:

We should keep in mind that those self-pompous Iberians – i.e. the Curopalates Iberians, claim they are the descendants of Huria's wife seduced by David, the prophet and the king. They say that they are descendants of the woman who gave birth to the child from David, and thus they are kins to the Holy Mother, as she herself descended from David.

They say that their dynasty comes from Jerusalem, and they left the place because of the vision that David and his brother Spandiat had. So they came to the borders of Persia and settled on the land they still live on now. This Spandiat was blessed and, according to the Iberians, no blade could wound him except in the heart area which he protected with a special cover. So the Persians were afraid of him very much; he gained victory over them and settled his kin Iberians in impassable lands. They still live there, and gradually spread and turned into a mighty nation. (Georgica, 1952, pp. 255-259)

The point is that this interpolation of genetic kinship to David the Prophet and the Holy Mother of God is the result of a Christian period and this motive substituted the Persian version of the Ahuramazda's descent. It is rather easy to be convinced that the main hero of this plot is Spandiat and not David: Spandiat, who was blessed by God and who was the ire of his enemies, the blade-proof hero, who took his people – the Iberian-Georgians in this case - to their new homeland, i.e. Georgia. Naturally, he should have been the forefather of these Georgians, but the Christian epoch, somehow, changed the essence of this myth. As we can see from Porphyrogenetos's subsequent narrative, Spandiat had no children, and the heritage descended over his Jewish "brother" David. But now the question arises: Who is Spandiat himself? Spandiat, the same Spandiat Rvali, as we have already mentioned, was the third king of the Achaemenids, the

forefather of the lateral branch of the Achaemenid dynasty on the throne of Persia, Darius I. He is the ethnarch and direct ancestor of the Achaemenid satraps that settled and ruled in Kartli. Naturally, the Achaemenid Spandiat would not have taken the so-called “Georgians” from Jerusalem; he could have brought them only from Ariana – Persia or (if we use the terms in *The Conversion of Georgia*) from Arian-Kartli. (No wonder the Georgians (Kartvels) could only have come from Kartli!) As we can see, here the semblance with the story of Azo’s arrival in Kartli is absolutely clear.

References

- Ancient Georgian Hagiography Literature Masterpieces. [zveli k’art’uli hagiograp’uli literaturis zeglebi]. (1971). Book III, p. 80, Tbilisi.
- Andronikashvili, M. (1966). Chronicles of Iranian-Georgian Language Relationships, I. [narkvevebi iranul-q’art’uli enobrivi urt’iert’obidan]. Tbilisi.
- Arakhamia, G. (2002). The First Chronicles of “Life of Kartli”. [k’art’lis c’xovrebis pirveli matiane]. Tbilisi. (Georgian)
- Bakradze, D. (1889). History of Georgia (From the old times to the end of 10th century). [sak’art’velos istoria]. Tbilisi.; Baratov, S. (1865). History of Georgia, 1. [istorja gruzii]; Kovalevskaia, V. (1875). Scythians, Dedia, Iran in Relations with Caucasia on the bases of Leonti Mroveli. Matsne.
- Georgica (1952). Byzantine Authors’ Data about Georgia. [bizantieli mcerlebis c’nobebi sak’art’velos šesaxeb]. The Text with the Georgian translation was published and the definitions were added by Kaukhchishvili S. Book IV, Part II, Tbilisi.
- Herodotus. (1975). History. [istroia]. Preface and Index translated by Kaukhchishvili T. I, Tbilisi.
- Kartlis Tskhovreba. (1955). [k’art’lis c’xovreba]. The texts stated by all basic transcripts according to Kaukhchishvili, S. I, Tbilisi. (Georgian)
- Melikishvili, G. (1959). History of Ancient Georgia. Tbilisi. [istorya drevej gruzii]; Khazaradze, N. (2001). Leonti Mroveli and Arian Kartli’s localization Issue. [leonti mroveli da arian k’art’lis lokalizaciis sakit’xi]. Delicatio, Historical Philological Searches. Tbilisi.

- Moktsevai Kartlisa. (1961). [mok'c'evai k'art'lisai]. Old Georgian Hagiographic Literature Masterpiece edited by Ilia Abuladze. Book I, Tbilisi.
- Sanadze, M. (2001). Life of Kartli and the Antient Period of History of Georgia. (From Kartlos to Mirian). [k'art'lis c'xovreba da sak'art'velos istoriis uzvelesi periodi (k'art'losidan mirianamde)]. Tbilisi. (Georgian)
- Sanadze, M. (2008). The first Sovereign of Achaemenids, Cyrus, and of „Life of Kartli” Nimrod (Georgian History). (Georgian) Caucasus Journal of Social Sciences. I. The University of Georgia. Tbilisi. (English)
- Sanadze, M. (2010). Chronology of Ancient Pre-Parnavas Part of Kartlis Tskhovreba. [k'art'lis c'xovrebis uzvelesi p'arnavazamdeli nacilis k'ronologia]. The University of Georgia The Second Annual Conference in Humanities, Tbilisi.
- Sanadze, M., Beradze, T. (1999) Antient Political and Geographic Description of Caucasus and the Creation Date. Meskheta III. [kavkasiis uzvelesipolitikur-geograp'iuli aḡceriloba da misi šedgenis dro-mesxet'i]. Tbilisi-Akhaltzikhe.

Linguistics and Culture

ქართველ მთიელთა რელიგიური აზროვნების სინკრეტიზაციის დინამიკა (ხევსურული რწმენა–წარმოდგენები)

ლუდუშაური თინათინ
საქართველოს უნივერსიტეტი

კვლევის ძირითადი მიზანია რელიგიური აზროვნების ორი ტიპის–
ტრადიციული (არქაული) და თანამედროვე (ქრისტიანული) შერწყ-
მის, გადაკვეთისა და კონტამინაცია/სინკრეტიზაციის ელემენ-
ტების გამოვლენა და განზოგადება, რაც ნათლად იკვეთება XIX
საუკუნის გერმანელი მეცნიერი–მოგზაურების (კ.ჰანი, გ.რადე,
ნ.ზაიდლიცი) მიერ კავკასიაში მოპოვებულ და დაფიქსირებულ
ეთნოგრაფიულ მასალაში. ამ ტიპის მონაცემები გერმანელ მეც-
ნიერთა შრომებში საკმარისი რაოდენობითაა და შესწავლისთვის
საინტერესო ობიექტს წარმოადგენს, რამდენადაც ერთი მხრივ ეს
უშუალოდ გერმანელ ავტორთა მიერ XIX საუკუნის შუა ხანებში
კავკასიაში, კერძოდ საქართველოს მთიანეთში მოპოვებული ორი-
გინალური მასალაა და, მეორე მხრივ საქართველოში ამ მონაცე-
მების უდიდესი ნაწილის მეცნიერული ანალიზი დღემდე არ
გაკეთებულა. მათი შედარება ქართველი ეთნოგრაფების ანალო-
გიურ მასალასთან ნათელყოფს, რომ ამ რეგიონის მოსახლეობის
რელიგიური აზროვნების სფეროში პრინციპული ცვლილებები
პრაქტიკულად არ მომხდარა და სხვაობები თავს იჩენენ იმ დონე-
ზე, როდესაც ისინი არ კარგავენ კავშირს ინვარიანტულ სქემასთან
და შეიძლება განვიხილოთ მხოლოდ ძირითადი ვერსიების ფორ-
მით. სავარაუდოა, რომ რელიგიური სინკრეტიზმი, რომელიც
მუდავნდება ადგილობრივ წარმოდგენებში, რელიგიური აზროვ-
ნების თანდათანობით სახე ცვლილებას უნდა შეესაბამებოდეს და,
ამ თვალსაზრისით, ხევსურული რწმენა–წარმოდგენები ერთ-ერთ
უძველეს ქართულ რელიგიურ არქეტიპად შეიძლება ჩაითვალოს.

Syncretization Dynamics of the Religious Thinking of Georgian Mounteneers (Khevsur Beliefs)

Gudushauri Tinatin
The University of Georgia

The worldview of the Georgian people, its beliefs, views, traditions, and cultural layers reflecting the influence of foreign cultures and universal values are clearly manifested in the ethnic culture of the nation. In this context, the uniqueness of religious beliefs of the Khevsurs - the inhabitants of a mountainous region in Eastern Georgia - is of special interest. It should be mentioned that this region has always had its own original culture, traditions, myths, rituals and ceremonies. A system of syncretic religious beliefs and variants of "popular Christianity" (Kandelaki, 1998, 42) have always been dominant here. This is primarily due to the fact that in the mountainous regions there was a kind of preservation of the remnants of the pre-Christian and the early Christian religions, which is the result of a certain reticence, the traditional character and resistance to the process of historical change.

The main objective of the study is to identify and synthesize the elements of connection, intersection, and syncretization of two types of religious thinking - the traditional (archaic) and the contemporary (Christian) one - which is clearly seen in the Caucasian ethnographic material of German scientists and travelers of XIX century (K. Hahn, R. Erkert, G. Radde, N. Seidlitz).

Materials of this nature are available in large quantities in German ethnographic studies and are an interesting object for study inasmuch as they were collected by the authors themselves in the Caucasus, particularly in the mountainous regions of Georgia in the middle of the XIX century, and for the most part have not been subjected to scientific analysis.

The analysis and juxtaposition of this material with the analogous studies by Georgian authors can lead to several conclusions.

First, it should be noted that Georgian mountaineers have a deep faith in the existence of a close relationship between this and the other worlds. The afterworld is virtually an idealized reflection of the real life, though with some specific features.

The second thing to emphasize is the perception of the universe as a whole, which is represented by the three levels each having a corresponding coloring; the great influence of this view on the funeral ritual as well as the existence of the idea of the eternal life and that of the sacral

center, implemented through the hearth, the heaven tower, a sacred poplar and a banner.

Third, it is assumed that the overall picture of the afterworld, a list of all sorts of crimes and punishments reflects the degree of socialization of the Khevsur society and points to the structurally weak and differentiated patriarchal community with a well-developed system of kinship, in which the remains of pre-Christian and early Christian religions have been mothballed.

And finally, taking into account the existence of pre-Christian religious elements in the Khevsur beliefs, on the one hand, and a certain resistance of the region to historical change, on the other hand, we may assume that religious syncretism, which manifests itself in local beliefs, may correspond to a gradual modification of religious thought, and that Khevsur beliefs are one of the oldest Georgian religious archetypes.

Since ancient times, a human could only live in a defined and a well-ordered universe (Eliade, 1995, 135). Traditional religious beliefs actually represent the view of the world order. The perception of the world order in the Khevsur religious thought takes a significant place in the ethnographic material collected by the German scholars. From this data, we may say that the universe is one whole for the Khevsurs, represented by the three cosmic layers or levels, each having a corresponding color (black, red, white) and is divided into the mortal life and the afterlife. This division and the link between the mortal life and the afterlife are crucial to the Khevsursian outlook. The Khevsurs believe that after death, life continues in the other world. In their view, the transition to the other world happens through a narrow bridge, constructed over a tar river, at the end of which judges sit and make decisions on the destiny of the dead by sending them to heaven or hell. The hell is represented with a dark closed quadrangle.

To the Khevsurs, heaven is a multi-storey white tower reaching the sky. It is brightly illuminated by the sun, next to the tower there grows a poplar that reaches the sky. Our attention was drawn to two things - the source of light and the role of the poplar. We believe that this may be a sign of the existence of a developed solar cult in the past, on the one hand, and the special significance of the sacral tree, on the other hand. The dead in the afterlife are allocated different cells; there is even a system called "mghebrebi," or "greeters" who are responsible for bringing the soul of the deceased to his/her cell called "antabi." The souls are placed on different floors of the tower in accordance with the measure of their guilt and are either in a bright or dim light; the very top of the tower is a place for innocent children, who play there. This corroborates our assumption that sometimes guilty people go to heaven, though they will certainly be punished with a dim light. This picture of heaven is in fact repeated in all ethnographic materials of Georgian authors, although sometimes the cri-

terion for the allocation of souls is the age – the elder are placed on the first floor and so forth; the same happens in case of the lighting. We tend to believe that this picture coincides with the potential of a person to sin – the lowest in childhood and the highest – in elder ages.

Symbolism related to the tree of life is highlighted in the picture of heaven. First, it takes the form of a white tower. It is known that a tower, a mountain, a tree are cosmological structures that have signs of universality. This impression is further enhanced by the poplar growing nearby. It seems that in the Khevsur heaven the tower and the tree are the symbols of the world axis passing through the sacral center and uniting the three levels of the universe, which represents the idea of an eternal life. The three-tier and three-color perception of the universe is a phenomenon characteristic of the Khevsur religious thinking. The special significance of such a view is displayed in the funeral traditions of Khevsurs. Typically, the deceased is dressed in three shirts of different colors – white, blue and red – the colors corresponding to the basic colors of the layers of the universe.

According to the evidence of the German scholars, the attitude towards the deceased occupies an important place. Attention is drawn to the fact that despite the beautiful picture of the heaven of Khevsurs, they are still afraid of death. This fear led to the emergence of a distinctive tradition associated with the deceased. This tradition does not permit a person to die at home – a dying person is taken out into the court. However if death does happen at home, the house is purified with a special ritual, as it is believed that the soul is pure, while the remains are putrid. To take care of the dead, there are the so-called "narevebi" or young people who are responsible for dressing the deceased; for deceased women, there are young ladies who serve as "narevebi." Because of their contact with the dead, "narevebi" become putrid. Therefore, according to the tradition, they stay in the house of the deceased for 6 or 7 days and bathe in the river every day. After the last bath, they are finally cleansed from putridity. The German scholar G. Merzbacher sees in this the influence of the laws of Moses (Merzbacher, 1901, 27). We think that this is most probably associated with pyrolatry, in particular, with the idea of putridity of the dust and cleaning means mentioned in the "Avesta."

A special significance of funeral wakes for the religious thinking of the Khevsurs should be pointed out. This is evidenced by the tradition of funeral repasts given while the deceased is still alive. This was usually done by lonely people who were not sure that after their death someone would arrange a funeral repast for them.

Mediators (mesulete) play a great role in relations with the other world. For the most part, mediators are women and girls. They communicate with the souls of the deceased and pass their wishes and predictions on to their relatives. If a child of a Khevsur falls ill, the cause of the

sickness is determined by mesulete. She tells the family if the cause of the disease comes from the deceased, that is, if the latter wants the child to be given his or her name. In this case, if the child is under 3, his or her name is changed. The mesulete also tells the family of the deceased what dishes the family must serve at the wake. The mediators must keep clean and sacrifice a sheep to a sanctuary 2-3 times a year. They do not charge for their service and are respected by people.

To sum up, the comparison of the German ethnographic data with related materials by Georgian authors shows that despite some changes, the religious beliefs of the Khevsurs always kept in touch with the invariant pattern of "popular Christianity," and can only be considered in terms of its basic versions.

References

- Kandelaki, M. (1998). Religious Syncretism and Socio-religious Institutions in Mountainous Georgia. [Religiuri sinkretizmi da soc'ialur-religiuri institutebi sak'art'velos mt'ianet'si]. *Annals*, 1. Tbilisi.
- Eliade, M. (1995). *The sacral and the profane*. [Das Heilige und das Profane]. Frankfurt am Main.
- Merzbacher, A. (1901). *From the high mountains of the Caucasus*. [Aus dem Hochgebirgen der Kaukasus]. Leipzig.
- Nioradze, A. (1931). *The funeral and the cult of the dead among the Khevsurians*. [Begräbnis und Totenkultus bei den Chevsuren]. Stuttgart.
- Hahn, C. (1900). *Pictures from the Caucasus. New studies for the knowledge of the Caucasians*. [Bilder aus dem Kaukasus, Neue Studien zur Kenntnis Kaukasiens]. Leipzig.
- Hahn, C. (1911). *New Caucasian traveling and studies*. [Neue Kaukasische Reisen und Studien]. Leipzig.

ბიბლიიზმი, ინტერდისციპლინარული ენობრივი ერთეული

მდივანი თამუნა
საქართველოს უნივერსიტეტი

სტატიაში გაშუქებულია ბიბლიიზმი, როგორ ინტერდისციპლინარული ერთეული, ბიბლიური კოგნიტური მეტაფორის ენობრივი გამოვლინება, რომელიც დასტურდება ყველა ქრისტიანულ ენობრივ სისტემაში. ბიბლიიზმი სინტაგმატურ ჭრილში ეკუთვნის ენობრივი იერარქიის სხვადასხვა დონეს, კერძოდ, მორფოლოგიურს, ლექსიკურსა და სემანტიკურს. აქედან გამომდინარე, ერთეულების შესწავლა ხდება სხვადასხვა დისციპლინის-ლექსიკოლოგიის, ფრაზეოლოგიისა და პარემიოლოგიის ფარგლებში. შესაბამისად, დასტურდება ერთეულების რამდენიმე ჯგუფი: სიტყვა ბიბლიიზმები, ფრაზეოლოგიური ერთეული ბიბლიიზმები და პარემიოლოგიური ერთეული ბიბლიიზმები-ბიბლიური ანდაზები და აფორიზმები. თითოეულ ჯგუფს ახასიათებს იმ დისციპლინების სინტაქსური თუ სემანტიკური მახასიათებლები, რომლის ფარგლებშიც ხდება მათი შესწავლა, მაგრამ ამავე დროს, აერთიანებს ბიბლიური კოგნიტური მეტაფორა, ბიბლიური ტროპი, რომელიც დასტურდება ყველა მათგანის სემანტიკურ სტრუქტურაში და რომელიც ერთეულს ინტერდისციპლინარულს ხდის.

Biblicisms, Interdisciplinary Language Units

Mdivani Tamuna
The University of Georgia

Centuries have been dedicated to studying the Bible-the divine book that interested so many scholars and scientists. The Bible has influenced not only the religion but the language and in general, the philosophy of the (Western) civilization. Despite geographical, cultural and eth-

nological differences, all Christians are united with comparably similar perception of the world, similar thesaurus, as the world vision and perception to a certain extent are determined by the religion itself. This, in my view, is well proved by a cognitive biblical metaphor belonging to the level of cognition and embedded in a language reality in various forms, including the ones determined as biblicisms. The biblicisms as the units of Christian languages vary according to time and space, but in spite of these variations they all preserve biblical archetypes, entering Christians' cognition throughout centuries and determining the way of their thinking, values and world vision.

Biblicism attracted the linguists' attention from the very beginning of the discipline. Linguists were basically interested in studying the biblicism as a type of phraseological unit (Kunin, 1972; Naumova, 2001; Sakvarelidze, 2001, among others), while late last century the study of biblicisms, as of a specific group, came to the front. The scholars already proceeded from the study of an independently functioning language unit (Fedoulenkova, 1997; Dubrovina, 1998; Khachapuridze 2004), which offered a wide range of material to literature, speech, etc., although the interdisciplinary nature of the unit was never mentioned.

Based on the model of a *language sign*, proposed by Lebanidze (1998), a biblicism as an interdisciplinary unit can be studied within syntagmatic and paradigmatic frameworks of the language system. In syntagmatics, a hierarchical topology of the signs are present, conditioned by the contradiction and interrelation of complete and incomplete signs, reflected on different levels of the hierarchy. Based on this concept, biblicisms, according to the syntagmatic approach, are present on morphological, lexical and semantic levels of the language hierarchy. On the morphological and lexical levels, the biblicism is represented by a single member unit-lexeme/word of biblical etymology, with the interdisciplinary characteristics, i.e. biblical trope revealed in its semantic structure as in the words «Paradise», «Angel», «Golgotha» and others with the equivalents traced in other languages as well (in Georgian, «Samotkhe», «Angelozi», «Golgota»; in Italian: «Paradiso», «Angelo», «Golgota»; in Russian: «Rai», «Angel», «Golgota», respectively). In these and other lexemes, when functioning as biblicisms, connotative meaning dominates denotative. For example, in «Angel», the denotative meaning of the word is a *divine creature*, while when functioning as a biblicism it describes a kind, honest and in general, a very positive person. The meaning of the word to a Christian is motivated without any special religious background knowledge, proving the common perception and thesaurus the Christian people have. «Sei proprio un angelo» (Eng: *you are a real angel*), an Italian will tell an addressee who has done him a favor; «Namdvili angelozia» (Eng: *is a real angel*) a Georgian would caress the child; «Be an angel and give me a hand», (International Dictionary of English, 1996, p. 44) an Englishman would apply to someone to ask for a help.

On the lexical level, another type of biblicism is also revealed - the maximal unit of the level – a biblical phraseological unit. As mentioned above, initially biblicism was only viewed from the phraseological approach, as phraseology was the only discipline within the framework of which the unit was studied. This, in my view, is due to the numeric number and importance of biblical phraseological units among other types. *Biblical phraseological units are the units of biblical etymology characterized by completely or partially (on components level) transferred meaning, and are represented at least by a two-member unit and often by a sentence.* Structurally they differ from word-biblicisms, but semantically they too contain biblical metaphor in their semantic structure. A biblical phraseological unit may be of biblical etymology with a direct prototype in the text of the Bible as «Daily bread» with inter-lingual equivalents: Georgian: «Puri Arsobisa», Russian «Khleb nasushnii», Italian «Pane quotidiano», all deriving from the prayer «Our Father»: «Give us today our daily bread» (Matthew 6:11). Nowadays the biblicism means something of vital importance and is so natural for the Christian languages that is evidenced in a large variety and different types of discourses. The same is true about the biblicisms, such as «Crown of thorns», «The garden of Adam», «To wash one's hands», etc. All these units derive directly from the Bible with prototypical phrases which can be either a free phrase, transferred out of the Bible or already a metaphoric unit. In the second case, we would deal with the units not deriving as ready made from the Bible, but formed based on a biblical event, personage, etc. That Christian nations perceive the world through the same lenses across different spaces is well-proven by identical biblicisms created by different languages without prototypical direct phrase in the Bible. For example, the biblicisms «Good works», «Doubting Thomas» with respective units in Italian, Georgian, and Russian Languages: «ketili saqmeebi», «urtsmuno toma», «Affari Buoni», «Fare come San Tommaso», «Dobrie dzela», «Foma nevernii». In spite of the fact that the syntactic metrics differ from language to language, all the units are united by common biblical metaphor present in their semantic structure. For example, in the mentioned unit «Doubting Thomas», it is infidelity, proceeding from a biblical event when the apostle Thomas did not believe in the resurrection of Christ until he saw Christ's wounds himself. Apart from similar biblicisms, a language may borrow a word from the Bible and based on its specific needs form a phraseological unit on its basis. Such units rarely coincide in languages, as in many cases, despite similar interpretation of biblical cognitive metaphors by different languages as argued above, the language may fill its metaphoric stock based on its needs and lack and consequently interpret some happening in «its own way». In the semantic structure of such units biblical archetype is mostly preserved: Georgian biblicism «Iudas Kerdzi» (Eng: dish of Judas), Italian «Ai tempi di Noe'» (Eng: of the times of Noah), Russian: «Kak u

Khrista za pazukhoi» (meaning to live comfortably without any needs), English “Amen to that,” etc. Despite these differences within the group of biblical phraseological units, they all preserve interdisciplinary biblical characteristics - biblical metaphor.

As the statistical study of the inter-lingual biblicisms used as the research material revealed, 42% of biblicisms have direct prototype in the Bible, while 58% are based on the Bible and formed by the languages.

Biblical words and phraseological units represent minimal and maximal units of the same hierarchy of the language system, but are studied within different disciplines - lexicology and phraseology. The interrelation of word and phraseological unit is one of the ardent issues dealt by linguistics. Frequently, the two types of units have been regarded identical because of the degree of commonality they have in common (Reformatski, 1967, Cachiari, 1993). Identification of the two types of units was basically because of metaphoric nature they are characterized by. Metaphor, in my opinion, is rather a general category, not only a distinctive feature for a phraseological unit but for other types of units not belonging to phraseology as well (Rusieshvili, 1989). Although in semantic aspect the two units have something in common (Berger, 1997, Alekhina, 1989), their structure should not be disregarded, as the word - the smallest part of the speech - is one story and the unity of words is another. A word is firstly part of a connotation and only afterwards it is part of a sentence. Proceeding from the said, phraseology should study a phrase, a unity of at least two words, while the word even complex in semantic structure, idiomatic and non-translatable in another language does not belong to phraseology, but should be studied by lexicology and lexicography (Larin, 1956). Together with lexicology, for the study of a metaphoric word another discipline should also be involved, in particular, stylistics-to decode stylistic devices present in the lexemes, although lexicology remains as the central discipline to study the word (Stubbs, 2002).

Another type of biblicism is proved on the semantic level of language hierarchies, where it is represented by the unit of a sentence structure: biblical proverb/aphorism, studied within paremiology. As a famous paremiologist Mieder describes, «Proverbs (are) those old gems of generationally tested wisdom, help us in our everyday life and communication to cope with the complexities of the modern human condition» (1995, p. 28). From the 1990s, the study of paremiology becomes rather actual. The opinions of the scholars as to what is included in the discipline differ (Ageno, 1960; Takhaishvili, 1961; Cram, 1983; Mieder, 1995; Rusieshvili, 2005). That the proverb as a basic object of the study of the discipline reflects the in-depth conceptualization of the world and cognitive perception (Rusieshvili, 2005) is, in my view, in the first place true about biblical proverbs, as they reflect all the possible situations or

events a human may face, the answer to the problems or issues, that may exist in the mankind.

Much has been said and written about the proverb, but its status has not been unanimously determined. According to Rusieshvili (2005, p. 6), one may distinguish among three different approaches to the proverb. The first approach coincides with the initial stage of the development of phraseology and is based on the concept that proverbs represent a part of phraseology, although they differ from idioms proper (Smirnitsky, 1956, Ageno, 1960.). According to this concept, a proverb is characterized by several peculiarities including metaphoric nature, transferred meaning, and fixed form, but at the same time it has features making it different from a phraseological unit, one of them being a communicative function it is usually used with. Based on another approach, a proverb is not included in phraseology, as it is not a PU* (Lejava, 1959, Anderson, 1971.) and therefore, is not characterized by structural and semantic peculiarities of a PU. Lejava thinks that a proverb is not a language unit, but a literary text (1959) while Emisova and Avaliani (Rusieshvili, 1999) regard it to be a communicative unit. According to the third concept, a proverb is a separate language sign, the unit of one of the levels of the language hierarchies (Dandes, 1975, Kartoziya, 1995). In spite of the similarity of PU and proverb, the difference between the two types of units is still noticeable: a proverb is a unit of general reference, while a PU has always its definite reference. At the same time, a proverb is based on in-depth, metaphoric perception of language rules, while a PU is a sensory - physical, rather superficial - and usual nomination of something, not to mention their structural difference, namely that a proverb always takes the form of a sentence while a PU can be a two word unit as well (Rusieshvili, 2005). Proceeding from this concept, although biblical archetype is present both in biblical PU and proverb, in a deep hierarchical structure of a proverb semantic opposition is revealed, something that is missing in the case of a PU. The examples of biblical proverbs are as follows: «Not to let one's left hand know what the right hand does», «Let us not be weary in well doing», «He who lives by the sword shall die by the sword», «When the blind leads the blind, both shall fall into the ditch», «Better a dinner of herbs than a stalled ox where hate is»; Italian: «Il buon vino allieta i cuori degliuomini», «Non dare le perle ai porci», «Perche` seminarano vento e raccoglierano tempesto», Georgian: «nu scnoobs marcxena sheni, rasa iqmodes marjvena sheni», «rasac dastes, imas moimki»; Russian: «Pust levaya ruka ne znaet chto tvorit pravaya» etc.. All these units differ in structure from the rest types of biblicisms, as they represent complete sentences with all the necessary elements of the sentence, while a word-biblicism is a single member unit, and a PU may be a phrase. Different from phraseological units, proverbs are provided to languages ready made (although in the course of time a ready made proverb may undergo

modification). Consequently, apart from lexicology, phraseology and stylistics, paremiology is also included in the study of biblicisms that once again points to the interdisciplinary nature of the biblicism.

The biblicism, characterized by a transferred meaning is metaphoric. The history of the study of metaphor is mostly the history of semantics. Although according to some viewpoints, the place of a metaphor is arguably within pragmatics. For example, Grice (1975) regards the metaphor to be the deviation from the norm together with irony and hyperbole. The norm in this case is a maxim. If the speaker violates the maxims, the listener tries to search similar proposition, implied by the speaker and tries to decode the said (Grice, 1975, pp. 115-120). Nebieridze regards pragmatics to have great influence on such semantic processes as they are metaphor, metonymy, and synecdoche (1991, p. 35). While according to a contrary viewpoint, metaphor is a semantic category and cannot not be studied within pragmatics. As distinct from both approaches, Rusieshvili thinks that a metaphor is a pragma-semantic category (Rusieshvili, 2003, p. 87). Supporting this concept, based on the first group of biblicisms, i.e. word-biblicisms, it can be argued that although in the units connotative meaning dominates denotative, metaphoric nature is only examined by the context- only in speech acts the unit as a biblicism is revealed. For example, independently taken units *Communion, Cross and Judas* out of the context may be regarded as the lexemes of religious meaning or as metaphoric units. The metaphoric nature is revealed in the context and the units may be correctly decoded by listener. As for other groups of biblicisms - PUs and proverbs, the units have the meaning independent from the context, while in the context they acquire additional load. As mentioned above, unlike a PU, a proverb is a unit of general reference and always has constative function (according to the classification of speech acts of Ostene, 1971). The semantic structure of a proverb is a unity of three hierarchical levels: 1. explicit meaning 2. implicit meaning 3. presupposition (Rusieshvili, 2005). To illustrate the said, in the proverb: «Not to let one's left hand know what one's right hand does» on explicit level an explicit opposite structure is registered: *Right-Left*, while on implicit level the unit is already decoded through semantic search, based on speaker's mentality, cultural schemata and the following meaning is registered: *do the good work hidden, the work done for others to see is not the good work*. On the propositional level, different associations may emerge, which would be basically intermingled with the context. The same is true about biblical phraseological units. In the discourse from Italian reality:

«*Ma adesso che posso fare io* »?

«*Chi cerca, trova*». (Eng: "Now what can I do? Who seeks, finds) the speaker of the speech act asks for the advice from the listener. Instead of giving a definite advice, the listener uses a biblical idiom which should be

decoded easily by the speaker proceeding from the background knowledge to learn about the pragmatic intention of the listener. On the explicit level, we face the opposite structure: *search-find* (as the unit derives from a biblical aphorism); on implicit level, the said is equipped with the illocutionary force of indirect directive and aims at encouraging the speaker, pushing to action, which can be regarded as the perlocutive force of the said, its presupposition. As it follows, among the biblicisms the first group -word biblicisms are always chained to the context, for example, speech acts they are used in to encode/decode their function as of biblicisms, while PU and proverb biblicisms acquire additional load, for example, perlocutive force in the speech acts, but their interdisciplinary characteristics is revealed even out of context.

Therefore, each group of biblicism is unique and is characterized by the peculiarities making the groups different from one another. In syntagmatics biblicisms are represented by the units of different levels of language hierarchies and are examined within the disciplines studying the units of these levels: *word-biblicism within lexicology, PU-biblicism within phraseology, proverb/aphorism i.e. sentence-biblicism within paremiology*. These disciplines differ from each other but at the same time are inter-chained. Three types of units are distinguished and united because of their interdisciplinary characteristics: *biblical etymology and metaphoric nature* present in all types of biblicisms.

References

- Khachapuridze, L. (2004). *Georgian Orthodox Parish Speech*. [k'art'veli mart'Imadidebeli mrevlis metkveleba]. Dissertation. Tbilisi.
- Lebanidze, G. (1998). *Antropocentrism and Communicative Linguistics*. [ant'ropoc'entrizmi da komunikac'iuri lingvistika]. Tbilisi: Language and Culture.
- Lejava, L. (1959). The Language of Georgian Proverbs. *The Structure of Georgian Languages*, ¹1, 139-167. [K'art'ul andazat'a ena. K'art'velur enat'a struk'turis sakit'xebi]
- Nebieridze, G. (1991). *Introduction to Linguistics*. [enat'mec'nierebis šesavali]. Tbilisi: Education.
- Ruseishvili, M. (1989). *Idioms in English, Georgian and Russian Languages*. [Idiomebi inglisur k'art'ul da rusul enebši]. Doctoral Thesis. Tbilisi
- Ruseishvili, M. (1995). *Proverb. Monography*. [Andaza. monograp'ia]. Tbilisi.
- Ruseishvili, M. (1999). *Proverb- Functional Issue, Semantic and Pragmatic Parameters*. [Andazebi-p'unck'c'iuri arsi, semantikuri da pragmatuli parametrebi]. Doctoral Thesis. Tbilisi. 89-101.

- Sakvarelidze, N. (2001) Theory of Translation. [T'argmnis t'eoris sakit'xebi]. Tbilisi University Press.
- Takiashvili, A. (1961). Georgian Phraseology. [k'art'uli p'razeologiis sakit'it'xebi]. Tbilisi. Press of Academy of Science.
- Alekhina, A.I. (1989). *Phraseological Unit*. [Frazeologièeskaja edinica]. Moscow: High School.
- Fedulenkova, T. (1997). *Phraseology of Bible*. [Biblejskaja frazeologija]. Omsk: Russia and the East.
- Kunin, A.V. (1972). *Modern English Phraseology*. [Sovremennaja Angliskaja Frazeologija]. Moscow: High School.
- Naumova, I.O. (2001). *Phraseological Commonalties of Biblical Origin in Russian and English in Language and Culture*. [Fraseologièeskaja sxodstva biblejskovo proisxaždenija v ruskom i angliskom jazike i literature]. *Journal Issues of Philology*. Russian Academy of Sciences, Institute of Foreign Languages. Moscow: R-T press.
- Smirnitsky, I. (1956). *English Lexicology*. [Leksikologija angliskovo jazika]. Moscow: University Press.
- Zagot, M. (2003). *Russian-English Dictionary of Biblicalism*. [Rusko-angliskji biblejskji slovar'] Moscow:Valent
- Agno, F. (1960). Premesa a un Repertorio di Frasi Proverbiali. *Romance Philolog*. XIII/3, 242-264.
- Anderson, S.R. (1971). *On the Linguistic Status of the Performative/Constative Distinction*. Indiana University: Linguistics Club.
- Austin, J. (1971). *Performative versus Constative*, in Searle: Philosophy of Language, London: CUP, .13-22.
- The Bible*, (1971). Glasgow: the British and Foreign Bible Society.
- Burger, H. (1998). Idiom and metaphor: their relation in theory and text. , in : *Phraseology and Paremiology (International Symposium, September 2-5, 1997, Liptovský Ján)*, Bratislava: Akadémia PZ, 30-36.
- Cambriadge, (1996). *International Dictionary of English*, London: Cambridge University Press.
- Cacciari, C. (1993). *The Place of Idioms in a Literal and Metaphorical World*. Hillsdale: Lawrence Erlbaum Associates.
- Cram, A. (1983). The linguistic status of the proverb. *Cahiers de Lexicologie*, 2, 43-78.
- Dandes, A (1975). On the Structure of the Proverb. *Proverbium* #5. Texas, 179-199.
- Dubrovina, K. (2001). From the Bible to Russian biblical idioms, retrieved August 28, from www.rudn.ru/en/?pagec=411.

- Larin ,A. (1956). On Phraseology, *journal: Philology*. №198, Moscow, 45-49.
- Grice, P. (1975). *Logic and Conversation in: Cole and Morgan Syntax and Semantics, Speech acts*. NY: New York Academic Press, 113-128.
- Mieder, W, (1995). The apple doesn't fall far from the tree; a historical and contextual proverb study based on books, archives and databases, de proverbso: *journal of international proverb studies*, N1, 200-289.
- Reformatskii', A.A. (1967). *Ocherki po yazikovedzeniu*. Moskva: Akadzemiya nauk.
- Stubbs, M. (2002). *Words and Phrases: Corpus Studies of Lexical Semantics*. Oxford: Blackwell.
- ASDA Baldini, M, (1999). *Milli Proverbi Italiani. tascabili feconomici newton*. Bologna: Zanboni.
- Casadei, F. (2001). *Breve Dizionario di Linguistica*, Roma (Carocci).

Footnote:

* PU-phraseological unit

21-ე საუკუნის რევოლუციების მეორე ტალღა - არაბული გაზაფხული

ბარბაქაძე სოფიო
საქართველოს უნივერსიტეტი

21-ე საუკუნის დასაწყისმა მსოფლიოს თავი რამდენიმე მნიშვნელოვანი მოვლენით დაამახსოვრა, რომელთა შორის ერთ-ერთი უმთავრესი რევოლუციების სრულიად ახალი ფორმის-ხავერდოვანი რევოლუციების გამოჩენა იყო. ხავერდოვანი რევოლუციის ცნების, მისი ხასიათის, წარმოშობის მიზეზებისა და სამომავლო განვითარების ირგვლივ აზრთა სხვადასხვაობა წარმოიშვა. ამასთანავე, 21-ე საუკუნის მეორე ათწლეულმა თან მოიტანა ხავერდოვანი რევოლუციის ახალი ფორმა, რომელიც „არაბული გაზაფხულის“, „არაბული გამოღვიძებისა“ და „უკრაინის რევოლუციის“ სახელითაა ცნობილი. სტატის მიზანს წარმოადგენს სწორედ ამ ახალი ფორმის რევოლუციის სიღრმისეული ანალიზი, მისი რევოლუციური პროცესის შესწავლა, არაბული რევოლუციის შედარება ტრადიციულ და ხავერდოვან რევოლუციებთან და მისი მნიშვნელობის დადგენა როგორც უშუალოდ ახლო აღმოსავლეთისთვის, ისე ხავერდოვანი რევოლუციების „პირველი ტალღის“ ქვეყნებისთვის უპირველეს ყოვლისა-საქართველოსთვის.

The Second Wave of Revolutions in the 21st Century - the Arab Spring

Barbakadze Sophio

The University of Georgia

The 21st century has been marked by several notable events, among them the emergence of a new form of revolution - a so-called "color revolution." There is a controversy over the definition, the character, the causes and the future of this phenomenon. While these questions still remain unanswered, yet another form of revolution has emerged known as an "Arab Spring", "Arab Awakening", and a "Jasmine Revolution." This article will provide an in-depth analysis of this new form of revolution. This will include studying the process of Arab revolutions, comparing the process with those of the traditional and of the Color Revolutions, defining its importance for the Middle East as well as for countries which have recently undergone color revolutions, first of all, for Georgia.

"The Arab revolt that started in Tunisia has opened a Pandora's Box that cannot be closed by brutally forcing opposition forces into submission" (Dorsey, 2011).

The spring of 2011 saw a rising wave of demonstrations in the countries of the Arab world. "In what became known as the Jasmine Revolution, a sudden and explosive wave of street protests ousted the authoritarian president, Zine el-Abidine Ben Ali, who had ruled with an iron hand for 23 years. On January 14, Mr. Ben Ali left the country, after trying unsuccessfully to placate the demonstrators with promises of elections" (The New York Times, 2011) this was the way the news about Tunisia (formerly a relatively peaceful "European country in Africa," afterwards known as the "cradle of Jasmine Revolution") were reported by all media sources throughout the world. After the successful revolution in Tunisia, the wave of demonstrations spread to Algeria, Morocco, Egypt, Jordan, Libya, Yemen, Bahrain, Oman and Syria (Fig. 1).

Signs of instability were observed in Kuwait, Lebanon, Djibouti, Saudi Arabia and Sudan. However the wave of unrest has passed the regional boundaries and has been echoed in the recent demonstrations in Sub-Saharan Africa, Europe, Caucasus, Asia and the Americas. Due to the limited size of this article, I will concentrate just on the events in Georgia later on.

Why the Arab Spring is not a true "Colour Revolution"?

From the very first days of the Arab Spring, parallels were drawn with the color revolutions of the first decade of the 21st century (which swept the post-Soviet regimes in a number of former-Soviet states including Georgia and Ukraine). The article will try to examine the revolutionary processes of the Arab Spring to find out whether "color revolution" is an appropriate term for this new phenomenon. We will analyse the recent processes in the Arab world to determine their general characteris-

tics and finally, to categorise the Arab Spring either as a “traditional” or a truly “colour” revolution. The best way to analyse any revolution is to go

Figure 1
Map of Arab Spring

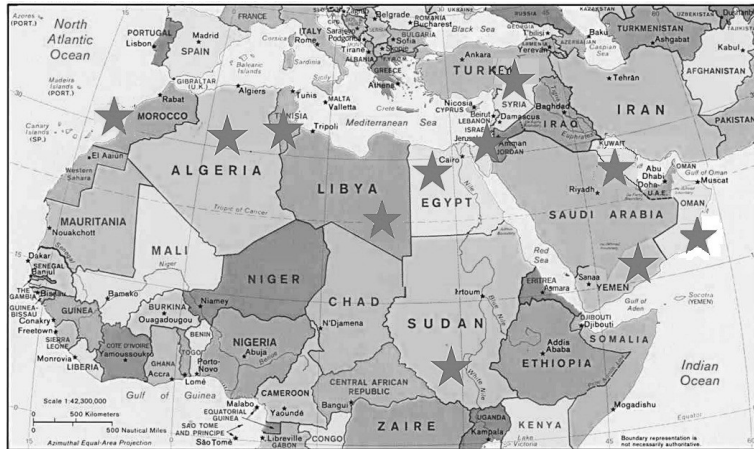

Retrieved from:
Google.com

step by step through seven phases of the revolutionary process (Fig No.2) before making any conclusions regarding its nature. However, as long as the Arab Spring has occurred rather recently, we can only put the first three phases (“Crisis”, “Fall of old regime” and “Honeymoon”) under discussion. Therefore, whatever the conclusions will be at the end of this article, they will definitely leave a space for contemplation.

Crisis and fall of the old regime are the first two phases of the revolutionary process. “As new desires arise, or as old desires grow stronger in various groups, or as environmental conditions change, and as institutions fail to change, a relative disequilibrium may arise and what we call a revolution break out” (Brinton, 1938). Usually, the financial, economic and social crises of the pre-revolutionary regimes are the roots of all revolutions- both traditional (France- 1789-1799, England- 1640-1660, America- 1775-1783, Russia- 1917) and color revolutions (Serbia’s 2000 Bulldozer Revolution, Georgia’s 2003 Rose Revolution, Ukraine’s 2005 Orange Revolution, Kyrgyzstan’s 2005 Tulip Revolution). However similarities between traditional and color revolutions end there. In the traditional revolutions fall of the old regime is preceded by the government’s *violence* against its people in an attempt to curb the riots and its failure to do so. In the color revolutions the government *doesn’t engage in violence* against the demonstrators - the only exception being Kyrgyzstan - with some violence occurring between demonstrators and government supporters (which seemed more like spontaneous clashes than a government-initiated violence).

Figure No. 2
Phases of the Revolutionary Process

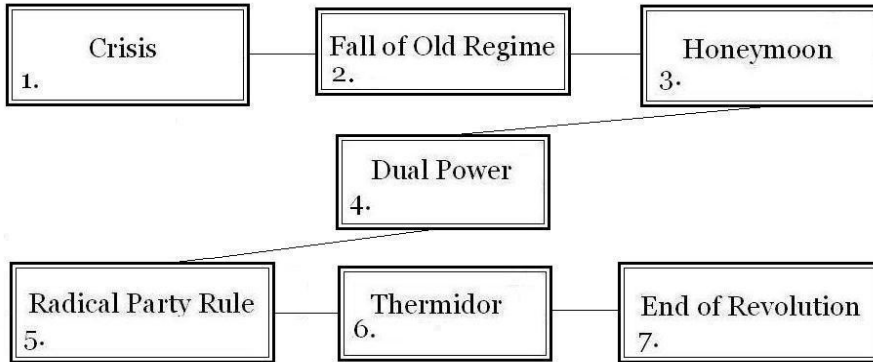

Roots of Arab Revolutions are no different: deep social, ethnic and religious problems of the Arab societies, most prominent of these being years of stagnation under one ruler and lack of a political representation of ethnic or religious minorities (for example, the Shiites in case of Bahrain) or both.

The author of the book “Anatomy of Revolution” Crane Brinton began his discussion of the phases of a revolutionary process by comparing a revolution to a disease, symptoms of which may be present for decades, far before the disease takes a severe form.

First symptom of a coming revolution is a growing *discontent over financial problems* in all social classes: For a number of reasons the wealth is not evenly distributed in a society, and even those who are relatively well-off, find the government hindering their economic activities. In the case of the American Revolution, the British policy had led to the accumulation of discontent among the American merchants while in the case of the French Revolution on-going tax reforms threatened the well-being of the higher classes. Same was true for the Color Revolutions: economic stagnation, overwhelming corruption and lack of prospects for doing business accumulated aggression inside all social classes of the post-soviet states. Same is partially true about the Arab Revolutions: Tunisia has seen a number of protests of the unemployed for years, public anger was fuelled after the Wikileaks published a report of a diplomat who attended a dinner with the family of the president Ben Ali: “A beachfront compound decorated with Roman artifacts; ice cream and frozen yogurt flown from St. Tropez, France; a Bangladeshi butler and South African nanny; and a pet tiger in a cage” (NY Times, 2011). Egyptian demonstrators have protested against high unemployment and rising prices of food (among other issues). Although

corruption index was higher in Libya than in both Tunisia and Egypt, the Libyan population enjoyed higher living standards, therefore demands for economic reforms were less frequently heard there (Howard, 2011).

Second symptom of a revolution: Unequal opportunities of people belonging to different classes were seen as a violation of *natural order* during traditional revolutions. The same problems were encountered by pre-color revolution societies and the societies of the Arab countries - this time the problems were named *violation of universal human rights*. Globalization and global exchange of information has increased the gap between what the governments should be and what they really are. Even the Syrian president Bashar Al-Assad (who rules a country by means of an almost 50-yr-long state of emergency) has admitted recently in a televised speech that a "government has to keep up with the aspirations of the people" (MWC News, 2011). Lack of democratic reforms has been perceived as a violation of natural order of things. We might say that this factor - and not economic problems - is the primary driving force of the Arab Revolutions. This assumption leads us directly to the revolutionary symptom No. 6: the intellectuals and ideas in the opposition (Table No.1).

"No ideas, no revolution," stated Brinton (Brinton 1938). Any revolution needs an idea to unite people, a "just cause" for what one should sacrifice one's life. Ideas may vary from "Liberty, Equality, Fraternity" of the 18th century France to "God, Syria, Freedom" in Syria to "people want to bring down the regime" elsewhere in the Arab world in the 21st century; however they still have a lot in common including, first of all, the force of uniting large numbers of individuals behind one cause. "We find that ideas are always a part of the prerevolutionary situation This does not mean that ideas cause revolutions, or that the best way to prevent revolutions is to censor ideas. It merely means that ideas form part of the mutually dependent variables we are studying" (Brinton, 1938).

Ideas are generated by a definite group of people - intellectuals, people with high education, usually coming from middle or upper classes, people who deny the ruling class their allegiance to begin anti-government activities. These are the people who begin to doubt the way their societies operate. i.e. *societies de pensee* in France, *the merchants' committees* in America, groups of *anarchists, westernizers, socialists, liberals, nihilists* and others in Russia.

In the Color Revolutions, individual intellectuals had also played their part, however the main driving force of the revolution were *opposition parties, youth organizations and NGOs*. During the Arab revolutions the educated *intellectuals (teachers, students, lawyers, etc.) and the*

public figures took the side of the demonstrators. However they failed to consolidate into an organization to further coordinate their activities and to drive the opposition forces forward. Up to now, there is almost no organization among protesters in Syria. The National Transitional Council is the only organizational unit in the Libyan opposition - however its objective is limited to coordinating resistance of the towns controlled by rebel forces. Situation was quite different in Egypt, where a number of organizations, including youth organizations (Youth for Justice and Freedom, Coalition of the Youth of the Revolution, Popular Democratic Movement for Change, National Association for Change and others) took an active part from the beginning of the street demonstrations. These are the organizations which also organized a "second day of rage" on the 28th of May with the demands to end the post-revolutionary military rule conducting mass violations of human rights from the very first days of coming to power (Martin, 2011).

Another important difference: the Color Revolutions would typically start *after a fraudulent election*, while the Arab revolutions began against an authoritarian ruler *without an election stolen*. (In this aspect, the Arab Revolutions resemble traditional revolutions.) At this point, we come upon *symptom No.3*: optimistic expectations of the society which are downplayed because the government is unwilling or unable to change.

The fact that the Color Revolutions were preceded by elections is much more important than it may seem. Actually it is the detail that contributed to a non-violent transition of power for several reasons. First, the pre-revolutionary governments had taken international commitments to guarantee free and fair elections. Therefore the opposition parties were permitted to conduct active election campaigns which informed and mobilized the society already in the pre-revolutionary period. For example, in Georgia all parties began election campaigns months before the Rose Revolution actually began. Political parties were granted free television time to articulate their agendas, political leaders took part in talk-shows and television debates. Due to mass flow of information, the society was highly politicized, politics being most popular topic of discussion everywhere - in families, in transport, in schools and universities throughout the country. Things were different in the Middle East: The opposition didn't have a chance to either organize itself, or to formulate its agenda and to inform the society about its aspirations. This is why the Arab Revolutions are called the "Facebook and Twitter Revolutions"- the social media being the only means of communication. According to one activist's post on twitter: "We use Facebook to schedule the protests, Twitter to coordinate, and YouTube to tell the world" (Howard, 2011). Let's take into account two

things: 1) the aggressive internet-censorship in all Arab countries most prominently in Syria, Egypt, Bahrain and Libya; 2) far less people (mostly youth) has access to the internet than to television. Due to these, the revolutions were spontaneous and fully depended on the aggression and dissatisfaction accumulated in the society for decades. These are the reasons why the Arab revolutions are much more difficult to organize, much more prolonged and violent than the color revolutions were. The Arab revolutions are also more difficult to predict. To measure vulnerability of any Arab country to the revolution The Economist has introduced its "*Shoe throwers index*" which has been quite helpful in making predictions and which represents a combination of various data: "35% of the index value is accounted for by the share of the population that is under 25; 15% is accounted for by the number of years the government has been in power; 15% by both corruption and lack of democracy indices; 10% by GDP per person; 5% by an index of censorship and 5% by the absolute number of people younger than 25" (The Economist, 2011).

The elections in Georgia in November 2003 made a great contribution to the *internationalization* of the Rose Revolution: great numbers of international organizations and foreign reporters arrived to observe the election: International Election Observation Mission (composed of the Parliamentary Assemblies of the OSCE), the Office for Democratic Institutions and Human Rights (ODIHR), International Society for Fair Elections and Democracy (ISFED) were some among many organizations which observed the elections to report the election fraud. It was these international organizations which provided the Georgian opposition with a "just cause" to fight for and ultimately led the country to the change of power, while the international media sources provided a 24-hour coverage of the events. Actually, the organizations and reporters who came to Georgia to monitor elections became witnesses of the revolution. International presence was one of the reasons why the Shevardnadze's government did not use force to suppress the demonstrations. On the other hand, the international presence was minimal in the countries of the Arab Spring, the only media source which reported the on-going events being Al-Jazeera, the international organizations present being the African Union, the Arab League, the Amnesty International and the International Human Rights Watch (in the context of years of repression these organizations would be much surprised to see a peaceful transition of power than the violence that occurred, therefore they didn't do anything what they were not doing through years, namely, calling for reforms which, traditionally, went unheeded.) This was why the governments did not feel particularly uncomfortable while conducting bloody attacks against their populations.

Here we should give a separate space to the *international intervention* on the side of the opposition in Libya. The event itself is of an utmost importance for regional as well as for global politics and requires far more space for analysis than this article can provide. Therefore here we can only point out the following: This is the only case in history of revolutions when a foreign force intervened on the side of the revolutionaries and took on itself almost the whole burden of military operations. If this trend will be repeated in other Arab countries (Syria being a most prominent candidate), we can speak of a totally new form of revolution which can be not only incited, planned, financed or directed from outside, but also actually accomplished by foreign forces. (In this case we could question ourselves whether the action of fighting for a foreign revolution is actually a revolution, also where does the line separating such revolution from an intervention like that of the 2008 Russo-Georgian war go and finally, what can we do to such universal principles as sovereignty and territorial integrity which directly forbid intervention in domestic affairs of states and which has been the bedrock of the international system for centuries.)

The expectations about what the regime change would be like was also important: In Georgia, the change of government was expected to take place by elections and later by peaceful resignation of the old regime. Expectations for escalation of the demonstrations to civil war were low most of the time (not to take into consideration several incidents including mobilization of the security forces and pro-government demonstrations). A common demonstrator which made a decision to join the manifestations did not have to fear for his life. In case of Arab revolutions expectancy for violence was very high. "Martyr" became a synonym for a "demonstrator" during Jasmine Revolutions, as each person going out to demonstrate had no guarantee of returning home alive. All of this information being summarized in the table 1. See on the next page:

So far, Jasmine Revolutions have succeeded in two Arab countries - Tunisia and Egypt (second phase of the revolutionary process, namely, the fall of the Old Regime). Power has been transferred to the former opposition (third phase, namely, the Honeymoon). The 4th and 5th phases of the revolutionary process (the Dual Power and the Radical Party Rule) in Tunisia and Egypt are especially interesting to observe, as long as here is where the differences begin. At this point situation in Tunisia can be generally assigned to the category of "dual power:" the interim government consists of 60 opposition parties, oldest and most popular of them being Ennahda ("renaissance" in Arabic). While elections have been postponed (allegedly because big numbers of Tunisians are not officially registered yet), fears arise regarding the tolerance and moderation of the party: "Rumors of attacks on unveiled women and artists, of bars and brothels sacked by party goons, of plots to turn the country into a caliphate [circulate among the coastal elite]. Ennahda's popularity and organizational strength are of growing concern to many activists and politicians, who worry that the secular revolution of January might see the birth of a conservative Islamic government in July" (NY Times, 2011).

Table №1

Symptoms of Revolution

Symptoms of a revolution	Traditional	Color	Arab
1. All social classes are discontent	√	√	√
2. People feel restless and held down by unacceptable restrictions on society, religion, economic activities or government.	√	√	√
3. People are hopeful about the future, but they are being forced to accept less than they had hoped for.	√	√	√
4. People are beginning to think of themselves as belonging to a social class, and there is a growing bitterness between social classes.	√	-	-
5. The social classes closest to one another are the most hostile.	√	-	-
6. The scholars and thinkers give up on the way their society operates.	√	√	-
7. The government does not respond to the needs of its society.	√	√	√
8. The leaders of the government and the ruling class begin to doubt themselves. Some join with opposition groups.	√	√	√
9. The government is unable to get enough support from any group to save itself.	√	√	√
10. The government cannot organize its finances correctly and is either going bankrupt or trying to tax heavily and unjustly	√	√	-
11. Impossible demands made of government which, if granted, would mean its end.	√	-	-
12. Unsuccessful government attempts to suppress revolutionaries.	√	-	√
13. Revolutionaries gain power and seem united.	√	√	-

In G. Anchabadze's opinion "For knowing the precise number of military force they periodically held a census. By the evidence of David's chronicle, the census of 1123 showed that the number of Kipchaks who carried arms reached 50,000. Since the natural growth of population couldn't be 20 %, it is suggested that in 1119-23 new groups of nomads from the North were resettled" (Anchabadze, 1990, p. 111).

P. Golden refers to I. Javakhishvili and shares his suggestion that the number of the settled foreigners was – 225.000 (Margishvili, 2006, p. 62).

By F. Kirzi-oghlu, the number 225.000 introduced by I. Javakhishvili was diminished and considering 6 people in one family, he determined the total number as 300.000, since the scholar multiplied 50.000 by 6 (Kirzioglu, 2002, p. 125). A. Yunusov shares the opinion (Unusov, 2000, p. 32).

N. Murghulia and V. Shusharin concluded that for determining the total number of the troopers that came to Georgia, one has to rely on the data of a census by David's chronicler (50.000) (Murghulia, Shusharin, 1998, p. 96). Such an interpretation of the text is reflected in the Russian translation of the Georgian chronicle: "He instantly summoned all his troops. By his order all came from his kingdom. He rose against Sultan; and Kipchaks, who were counted over again that time, were 50000" (Murghulia, Shusharin, 1998, p.215). The translation is not adequate to the Georgian text. Before launching a campaign to Shirvan the Georgian king gathered the army and as David's chronicler notes, "He quickly summoned all his army and by his order an army from all his kingdom gathered before him and came forward against Sultan; Kipchaks were counted over again; the fighters that he found, were 50000. As soon as Sultan was informed about their arrival, power and number of his army, he was scared, left the place where was camped and was sheltered in the city" (Life of King of Kings David, 1992, p. 194). In the considered context, the number 50000 implies the army as a whole and not only Kipchaks. It also seems to be confirmed in the following excerpt of the same chronicle. Before taking Anisi, David once again called his army: "He quickly sent written invitations and on the third day 60000 warriors were before him. He moved and on the third day took the city" (Life of King of Kings David, 1992, p. 197). As one can see, there is no big difference between those two numbers – 50.000-60.000. The indication of the 60.000 (in Georgian - "samotsi" – means "three twenties") in the latter context can probably be explained by the desire to repeat number "three", which is preferable in "Kartlis Tskhovreba" because of its sacral meaning: "On the third day "samotsi" (three twenties) thousand warriors stood before him. He raised and on the third day easily took the town Anisi and its fortresses and villages and the lands around Anisi" (Life of King of Kings David, 1992, p. 197).

The evidence of Matheos Urkhaetsi, in which the participants of the Battle of Didgory are named one by one, seems to be more correct: "...With 40.000 strong and courageous men and warriors, experienced in warlike activities; He also had other troop from the Khapchakh (Kipchak) king – 15000; bold and selected men from Ossetian tribe – 500, Franks – 100" (Murghulia, Shusharin, 1998, p. 134). The evidence of the Armenian chronicler of the 13th c. Smbat Sparapet, according to which the king "gathered all his army, invited for help 40.000 Kipchaks, 18000 Alans, 10000 Armenians, 500 Franks" (Murghulia, Shusharin, 1998, p. 83-84) - seems less reliable.

According to the Georgian chronicler, settling the Kipchaks helped David to be successful. Just after that, the Georgian king "began to raid Persia, Sharvan and Great Armenia" (Life of King of Kings David, 1992, p. 185). After the settling of Kipchaks, they are supposed to have participated in all campaigns, no matter the Georgian chronicler mentions them in all cases or not.

The Arab chronicler Ibn al-Athir (13th c.) indicates that in the Battle of Didgori in 1121, which was followed by joining Tbilisi in 1122, Kurjs (Gurjs) came out jointly with Kipchaks. This record alone is sufficient to make it obvious that Kipchaks were the advanced guard of the Georgian army. That is why before the battle "200 men from Kipchaks came forward- entered the midst (of Moslems) and shot arrows" (Ibn al-Athir, 1966, p.567).

An issue which draws our attention is the process of assimilation of Kipchaks who were settled in Georgia and their relationship with the local population. According to P. Golden, "The use of a large foreign army (the Kipchaks) to be settled in the country was a daring move which, had the arrangements soured, could have had disastrous, perhaps fatal, effects on Georgia" (Margishvili, 2006, p. 61).

The evidence of David's chronicler that "Bulk of Kipchaks day by day became Christians and their big number was added to Christianity" (Life of King of Kings David, 1992, p. 185) in the Georgian scholarly literature is interpreted with some exaggerations. According to I. Javachishvili, Kipchaks who were resettled in Georgia, "learned Georgian and became Georgians and no one from their descendants was left as Kipchak, but everybody without any compulsion became Georgian voluntarily" (Javakhishvili, 1983, p. 216).

The opinion above was shared by other scholars. However, related records fail to confirm this suggestion and present a different picture.

David's chronicler emphasized that from the very beginning - after settling Kipchaks in Georgia to the king tried assimilate them; he started the process by their conversion to Christianity. However, the process of Christianizing as well as the Georgianizing of the foreigners was not so successful and their relationship with the local population as well as with

the king himself was rather complicated. The chronicler does not hide the fact that Kipchaks frequently took prisoners from among the population, and the king was forced to ransom them: "Who can count the prisoners who were liberated by Him and were ransomed from Kipchak relatives by fee" (Life of King of Kings David, 1992, p. 210). P. Golden suggests that problems came from other Kipchaks who were not in Georgian service and were not allies of Georgians (Margishvili, 2006, p. 74-75). Indeed, "Kipchaks of Daruband" are also mentioned in the source. However this suggestion is not easy to share fully, since one can see that Kipchaks, who were settled in Georgia, did not spare the Georgian king him, frequently betrayed him and organized plots against him. "How many times Kipchaks planned treason: established leaders, bold, some of them with sword, some with spear, some with In Egypt hundreds of thousands of people returned to the Tahrir square in Cairo to demand an immediate end of the military rule, which came to power after the Jasmine Revolution. "Demonstrators voiced calls for a "second revolution," expressing widespread sentiment that the revolution that brought down Mubarak has not resulted in any fundamental improvement in the conditions of life for the masses of working people, small farmers and agricultural laborers" (Martin, 2011). Various sources report numerous violations of human rights and violations of fair trial rights in Egypt: Thousands of civilians have been tried before the military courts for "crimes" like "protesting peacefully, breaking curfews, and various bogus charges, including possessing illegal weapons, destroying public property, theft, assault, or threatening violence. Those charged were judged guilty by accusation and denied lawyers of their choice to represent them" (Lendman, 2011). Let us bear in mind that such crimes are the subject of a civil, not a military court. Current unrest in Egypt makes it clear: The Egyptian revolution has missed the phase of "dual power" and has directly succumbed to the phase of the "radical party rule," also called "the reign of Terror and Virtue." According to the author of "Anatomy of Revolution," this phase is characterized "on the one hand with ... abundance of executions and repression; and on the other hand with "organized asceticism" ruling out such "social vices" as gambling, alcoholic drinks, and prostitution" (Brinton, 1938). Current "virginity tests" reportedly conducted against young women demonstrators speak for themselves. "One detainee, Salwa Hosseini, says she and the other 16 women were tied up, slapped, shocked with a stun gun, and called prostitutes, then strip-searched and forced to undergo the virginity

exam by a man in a white coat — while soldiers watched” (The Week, 2011).

From the very first phase of analysis, it is evident that the Arab Revolutions have lost the main attribute of the Color Revolutions - non-violent character of the revolutionary process. The security forces have attacked demonstrators in Syria, Libya and Bahrain, leaving hundreds dead and injured (thousands, reportedly, have been arrested). This is how a reporter from Al-Jazeera describes situation in Syria: “Syrian regime is likely to follow in the footsteps of Bahrain and beyond. In other words, it's pre-empting further escalation of popular upheaval through a campaign of nation-wide arrests and military deployment to the country's civilian hotspotsSo far, hundreds have been killed in only a few days” (Bishara, 2011). Frequent clashes between the demonstrators and the pro-government activists or the riot police took lives of many in Yemen, Algeria and Oman. (The only exception is Morocco where no violent acts were reported.)

One should not fail to notice that the Jasmine revolutions are in many ways different from the Color Revolutions. In fact, they stand somewhere in-between the traditional and the Color Revolutions, bearing resemblance to both. While the Color Revolutions are “true children” of the 21st century (with the globalization, internationalization of domestic issues, politicization of formerly-not political issues, etc.), the Jasmine Revolutions seem more like the vestiges of the 20th century (mostly because nothing much had changed in the Arab world for the past five decades either in terms of human rights, the freedom of speech or political representation). To be realistic, it was quite impossible to conduct peaceful color revolutions in the Middle East, where the existing regimes, the political traditions, the human rights index, the political, social, economic, ethnic and religious environment, all predicted that revolution - whatever form its process takes - would definitely be accompanied by violence.

Impact of Jasmine Revolutions on Georgia

Wave of Jasmine Revolutions swept the Arab World with violent demonstrations; however it didn't leave the rest of the world untouched. Discussions whether the revolutionary wave would reach Georgia and what its impact on our domestic processes would be like began already in the beginning of the year. Numbers of probable scenarios were written

and discussed in the Georgian media; meanwhile the anti-government protests in fact began in Tbilisi on May 21, 2011. Demonstrations were headed by the ex-parliamentary speaker and leader of the Democratic Movement-United Georgia party Nino Burjanadze. After five days of protests, the demonstrations were suppressed by police forces. No further protests been planned so far.

One of the purposes of this article is to reveal why the second revolutionary wave has passed Georgia by. Let us examine the events of May 2011 through the prism of the revolutionary process. According to the author of "Anatomy of Revolution," a revolution is like a virus, a disease accompanied by high "fever" (domestic disorder, civil disobedience, and, in extreme cases, violence). When the "fever" is over and the patient recovers, he may be "immunized at least for a while from a similar attack, ... [t]he parallel goes through to the end, for societies which undergo . . . revolution are perhaps in some respect stronger for it (Brinton, 1938). This is definitely true for Georgia, the country which has undergone the last revolution some only seven years ago. According to one Georgian author: "Georgia has undergone two coups in the last 20 years and the Georgian people know very well what it means to have armed men in the streets. People remember that bitter experience and they will not risk the current social security for indefinite future (Rezonansi, 2011).

The case of Georgia is the best example of the "revolutional immunity." The idea is the following: Revolutions begin with ambitious aims to change everything including the way of life, the way of thinking, the way of how-the-order-of-things-should-be, ultimately, changing the society itself. However, as a patient does not turn into a new man after recovery, so do societies remain mostly the same after revolutions: "Societies which undergo . . . revolution are perhaps in some respect stronger for it; but they by no means emerge entirely remade" (Brinton, 1938). The "revolutional immunity" is the intuitive knowledge that *substantial changes need stability more than revolutions* generated inside the society after results of the first revolution are clear.

The "revolutional immunity" can also be acquired through the theoretical knowledge and the centuries of historic experience: each revolution has a fairly good chance of ending up with a radical government. Probably one example from history would make it clear: Zbigniew Brzezinski (National Security Advisor during presidency of Jimmy Carter) insisted to maintain support of Iran's Shah during the Iranian Revolution. Knowing principles of a revolutionary process Brzezinski foresaw that the moderate Iranian government would not be able to stay in power for long. The only way of keeping radicals away from power in Iran was preventing a revolution. However Brzezinski's recommendations were left unheeded; as a result, a radical Iranian government under Ayatollah Khomeini soon overthrew the moderates and the USA finally lost its strategic partner in the region.

“When President Obama stepped into the State Department on May 19 to deliver his long-awaited speech on the Middle East, he did so amid fears that the Arab Spring was devolving into a Summer of Discontent. Egypt was sagging under a weakening economy and escalating crime; NATO's efforts in Libya were stuck in neutral; the Syrian government was boasting that its rebellion was over. Sectarian tensions were roiling Bahrain and Syria, and a wave of church burnings in Cairo had spawned a week of deadly violence between Muslims and Christians” (Feiler, 2011). This small extract from the Times publication (June 6) very well describes the first results of the Arab revolutions; it can also well serve as a conclusion to this article.

References

- Atlantic Times, 2011, The Arab Revolution is not Over Yet .
- Bishara, M. (2011, April 25), Patterns in the Arab Revolution, *Al-Jazeera*, retrieved on May, 1, 2011 from <http://english.aljazeera.net/indepth/opinion/2011/04/201142519220232412.html>
- Dorsey, J.M. (2011, June 2), Yemen revolt becomes naked struggle for power, *Alarabia*, retrieved on June, 7, 2011 from <http://english.alarabiya.net/articles/2011/06/02/151568.html>
- Feiler, B. (2011, June 6) Faith in the Arab Spring, *Time*, retrieved on June, 7, 2011 from <http://www.time.com/time/magazine/article/0,9171,2074093,00.html#ixzz1NkV9XU9h>
- Howard, P. N., (2011, February 23) The Arab Spring's Cascading Effects, *MillerMcCune*, retrieved on May, 10, 2011 from <http://www.miller-mccune.com/politics/the-cascading-effects-of-the-arab-spring-28575/>
- Huffpost, (2011, March 4), Arab Revolutions: From Tunisia To Egypt, Is This The Beginning Of A Trend? retrieved on May, 10, 2011 from http://www.huffingtonpost.com/2011/02/01/egypt-tunisia-arab-revolution_n_816695.html
- Lendman, S. (2011, May 22), Killings, Detentions and Torture in Egypt, *Inteldaily*, retrieved on May, 30, 2011 from <http://inteldaily.com/2011/05/killings-detentions-and-torture-in-egypt/>
- Martin, P. (2011, May 30), Mass protests demand “second revolution” in Egypt, *The Global Realm*, retrieved on May, 30, 2011 from <http://theglobalrealm.com/2011/05/30/mass-protests-demand-%E2%80%9Csecond-revolution%E2%80%9D-in-egypt/>

- Howard, P. N., (2011, February 23) The Arab Spring's Cascading Effects, *MillerMcCune*, retrieved on May, 10, 2011 from <http://www.miller-mccune.com/politics/the-cascading-effects-of-the-arab-spring-28575/>
- Huffpost, (2011, March 4), Arab Revolutions: From Tunisia To Egypt, Is This The Beginning Of A Trend? retrieved on May, 10, 2011 from http://www.huffingtonpost.com/2011/02/01/egypt-tunisia-arab-revolution_n_816695.html
- Lendman, S. (2011, May 22), Killings, Detentions and Torture in Egypt, *Inteldaily*, retrieved on May, 30, 2011 from <http://inteldaily.com/2011/05/killings-detentions-and-torture-in-egypt/>
- Martin, P. (2011, May 30), Mass protests demand "second revolution" in Egypt, *The Global Realm*, retrieved on May, 30, 2011 from <http://theglobalrealm.com/2011/05/30/mass-protests-demand-%E2%80%9Csecond-revolution%E2%80%9D-in-egypt/>
- MWC News, (2011, April 16) Syria's Emergency Law to be Lifted, retrieved on May, 12, 2011 from <http://mwcnews.net/news/middle-east/10045-syrias-emergency-law-to-be-lifted.html>
- NYTimes, (2011, June 8) Tunisia, retrieved on June, 10, 2011 from <http://topics.nytimes.com/top/news/international/countriesandterritories/tunisia/index.html?scp=1&sq=jasmine%20revolution&st=cse>
- Spiegel Online International, (2011) The Arab Revolution, retrieved on May, 15, 2011 from http://www.spiegel.de/international/topic/the_arab_revolution/
- Stratfor Global Intelligence, (2011) <http://www.stratfor.com/>
- The Economist, (Feb., 10, 2011) Where is the Next Upheaval? retrieved on April, 15, 2011 from <http://www.economist.com/node/18114401>
- The Week, (June, 1, 2011), Egypt's Revolting, Forced Virginity Tests, retrieved on June, 4, 2011 from <http://theweek.com/article/index/215815/egypts-revolting-forced-virginity-tests>
- Rezonansi, (2011, February 21), Georgia without Revolution? [sak'art'velo revoluc'iis gareše?]. Retrieved on April, 15, 2011 from http://www.resonance-daily.com/index.php?opt=post&id_post=50

რუსეთის საგარეო პოლიტიკა საქართველოსთან მიმართებაში 2000 წლის ვლადიმერ პუტინის არჩევნებისა და 2003 წლის ვარდების რევოლუციის პერიოდში

რუსო რიჩარდი
ხაზარის უნივერსიტეტი

1991 წლის საქართველოს დამოუკიდებლობის აღიარების და 2000 წლის მარტში რუსეთის პრეზიდენტად ვლადიმერ პუტინის არჩევის შემდეგ ქვეყნის საგარეო პოლიტიკა რეგიონში მნიშვნელოვანწილად იმართებოდა რუსული ინტერესებიდან გამომდინარე და მისი როლი აღიქმებოდა, როგორც მედიატორის როლი ეთნიკურ დისკუსიებში. რუსეთისთვის კავკასიის როგორც „სასიცოცხლო მნიშვნელობის მქონე ზონად“ დასახელება ხსნის რუსეთის მიერ საქართველოს საშინაო საქმეებში ჩარევას. მეორეს მხრივ, ეთნო-პოლიტიკურმა კონფლიქტებმა, პოლიტიკურმა არასტაბილურობამ, ჯერ კიდევ არამყარმა პოლიტიკურმა სტრუქტურებმა და რუსეთზე ეკონომიკურმა დამოკიდებულებამ განაპირობა, რომ საქართველო ჯერ კიდევ დაუცველია რუსეთის მხრიდან ზეწოლისა და მანიპულირებისაგან. 2000 წელს, როდესაც რუსეთის პრეზიდენტად ვლადიმერ პუტინი აირჩიეს, კრემლმა კიდევ უფრო გააძლიერა საქართველოს კონტროლი. მთავარი მიზანი იყო თბილისს აეღო პრორუსული საგარეო პოლიტიკის ხაზი. აღნიშნული სტატია იკვლევს იმ მეთოდებს, რომელსაც კრემლი იყენებდა საქართველოს დასამორჩილებლად 2000-დან 2003 წლამდე, როდესაც საქართველოს პრეზიდენტად მიხეილ სააკაშვილი აირჩიეს.

Dimensions of Russian Foreign Policy towards Georgia between Vladimir Putin's 2000 Election and the 2003 Rose Revolution

Rousseau Richard
Khazar University

Ever since it declared independence in 1991, Georgia has found that its historic ties with Russia have complicated its search for an identity at the international level. This has complicated Georgia's foreign policy for more than a decade. Georgia has moved back and forth between a strategy of distancing itself from the Russian sphere of influence, striving for even better relations with the United States and Europe, and seeking, even if reluctantly, some sort of accommodation with Russia.

Thus it would be fair to describe the tangled relations between Russia and Georgia as tense, delicate and highly vulnerable. The range of thorny problems – namely, the long term existence of Russian military bases on Georgian territory, Moscow's involvement in the breakaway regions of Abkhazia and South Ossetia, Russian companies' nearly total control of the Georgian energy sector, controversy over the energy transit routes from the Caspian Sea region, the war in Chechnya and Moscow's position on the alleged presence of Chechen fighters in what it called the "lawless" Pankisi Gorge – continue to systematically poison the relationship between Moscow and Tbilisi.

Geopolitically, Russia views the South Caucasus in general and Georgia in particular, as a region vital to its national interests. Exercising geostrategic and economic control over Georgia – a key transit country – has been, and continues to be, the paramount objective of Moscow's strategic planners. It is only natural that Russia has pursued a combination of policies (the imposition of a unilateral visa regime in December 2000, cutting off energy supplies and backtracking on commitments to withdraw Russia's military bases from Georgia) to discourage Georgia from acting on its pro-Western leanings. Georgia desires to join NATO and become a member of the European Union (EU); participates in the Baku-Tbilisi-Ceyhan oil pipeline project; and is part of the Georgia-Ukraine-Azerbaijan-Moldova (GUAM) organization, widely regarded by Moscow as an obstacle to its integrationist plans.

When Vladimir Putin was elected Russia's President in 2000, the Kremlin became increasingly focused on manipulating and controlling Georgia. The objective was to force Tbilisi to toe a pro-Russian foreign policy line. To achieve this, Moscow was willing to resort not only to the

threat of using raw force but much subtler tools – including political and economic blackmail – that have become part of the now commonly called “soft powers.”

I. Main Problematic Areas between Georgia and Russia during Putin's First Term

As briefly explained in the introduction, there were various problems that strained Russian-Georgian relations between 2000 and 2003:

- The existence of Russian military bases on Georgian territory
- Tension in the separatist regions of Abkhazia and South Ossetia
- The alleged presence of Chechen rebels in the Pankisi Gorge
- Russian companies' monopoly in the Georgian energy sector
- The energy transit routes running across Georgia from the Caspian Sea region.

We will examine each of these issues in turn.

Russian Bases on Georgian Territory

Russia agreed to withdraw its four military bases in Georgia under an Organization for Security and Cooperation in Europe's (OSCE) summit agreement when it adopted the Treaty on Conventional Armed Forces in Europe (CFE) (The CFE Treaty, 1990), in Istanbul on 19 November 1999, following a Russian-Georgian statement to this effect in November 1994 (Boese, 1999, November).

The CFE Treaty, among other things, imposed equal limits on the tanks, armoured combat vehicles (ACVs), heavy artillery, combat aircraft and attack helicopters that NATO and the former Warsaw Pact countries could possess between the Atlantic Ocean and the Ural Mountains. Aimed at preventing arms build-ups for surprise *blitzkrieg*-type offensives, the treaty employed a concentric-zone system which mandated smaller deployments of tanks, ACVs and artillery the closer one moved toward the frontline between the alliances. To guard against offensives designed to bypass central Europe, specific 'flank zone' limits restricted weapons stationed in northern and southern Europe. The treaty adaptation agreement on November 19, 1999 overhauled the outdated, Cold War-era structure of the original treaty. While proclaiming the adapted treaty will “enhance peace, security and stability throughout Europe,” U.S. President Bill Clinton said he would not submit it for Senate approval until Russia complies with weapons ceilings set out in the revised treaty. Moscow, whose war in Chechnya in 2004-2006 had only magnified Russia's perennial non-compliance with CFE flank-zone limits, had said it will comply as soon as possible.

The Vaziani and Gudauta bases, under the CFE Treaty, were to be vacated by 1 July 2001, with further consultations to decide the dates for the evacuation of the Batumi and Akhalkalaki bases. Russia left Vaziani and Gudauta in accordance with CFE stipulations but did not withdraw from the other two: Batumi (in Adjara) and Akhalkalaki (in Samtskhe-Javakheti) (Mukhin, 2000; Pravda, 2001; Rosbalt, 2002; Rosbalt, 2004). The Georgian authorities demanded that Russia evacuate its bases in accordance with the CFE Treaty while Russia argued that it had already reduced by several hundred units the heavy military hardware at its remaining bases in Batumi and Akhalkalaki and that it needed 11 more years for a complete withdrawal.

Furthermore, two other groups of Russian military forces, under the aegis of Commonwealth of Independent States (CIS) peacekeeping operations, were deployed in Abkhazia and South Ossetia, while some more Russian troops were positioned in Gyumri in Armenia. The main concerns about the Russian military presence in Georgia were, firstly, the possibility of Russian intervention in Georgia's internal affairs and, secondly, the Russian tendency not to maintain its declared neutrality.

These issues remained the main causes of friction between Russia and Georgia under both Presidents' Eduard Shevardnadze and Mikheil Saakashvili administrations. As Igor Torbakov mentioned in an article published in *Eurasianet* (Torbakov, 2004), "Moscow Views Military Withdrawal Issue as Litmus Test for Georgian-Russian Relations," Russia tended to see the base issue as a litmus test for the future of bilateral relations, while the Georgian side viewed it as a test of Russia's sincerity in resolving the other important problems between the two states.

This issue was one of the main items on the agenda when President Saakashvili visited Russia in February 2004 (Blagov, 2004). Although, little progress was achieved, Saakashvili explained that "this issue is important to Georgia but we can't allow it to darken our relations."

1.2. South Ossetia and Abkhazia

The collapse of the Soviet Union led to large-scale armed conflicts in a number of the newly independent states. Since each conflict in the region has its own causes, it is very difficult to generalize on the sources and driving forces behind them. However, it is also very hard to analyze each individual conflict separately because many regional conflicts are closely interrelated and affect each other in different ways.

Difficulty in state formation and complex border delimitation and territorial claims were the main factors contributing to the emergence of the conflicts in the post-Soviet space. The existence of some common characteristics complicated the resolution of conflicts in the region: lack of experience of and structures for independent government; the lack of

national armies; unresolved territorial and regional disputes; the presence of Russian armed forces in most of the regional countries. The picture gets even more complicated if we take into account Russia's political and security interests, its desire for strategic dominance and the fate of the Russian diaspora in the new independent states (Shanin, 1989; Yamskov, 1991; Baranovsky, 1993, p.95, 131; Goldenberg, 1994, p. 4).

The Ossetians joined Russia in 1774 and, in June 1920, South Ossetia declared its independence as a Soviet Republic. Georgia sent its army to crush what it saw as a South Ossetian uprising challenging the territorial integrity of Georgia. Russia protested against this action, considering it as an intervention into South Ossetian internal affairs. The South Ossetians saw this as a denial of their right to self-determination, while the Georgians continue until this day to view these events as the Ossetians' first attempt to seize Georgian territory and Russia's first attempt to destabilize Georgia by encouraging South Ossetia to secede. In 1921, the Red Army invaded Georgia and annexed it. In 1922, the South Ossetian Autonomous Oblast within Georgia was declared, with Tskhinvali as its capital city. It remained an Autonomous Oblast within Georgia under Soviet rule, having strong ties with the North Ossetian Autonomous Region in the Russian Soviet Federative Socialist Republic (Shukman, 1988, p. 234-235).

In September 1990 the South Ossetian Autonomous Oblast declared independence as the South Ossetian Democratic Soviet Republic, appealing to Russia to recognize it as an independent subject of the Soviet Union. The South Ossetians boycotted the elections for the Georgian Supreme Council in October 1990 and held elections for their own parliament in December. However, the Georgian Supreme Council cancelled the results of that election and voted to abolish the South Ossetian Autonomous Oblast as a separate administrative unit within the Republic of Georgia.

Following violent incidents in and around Tskhinvali, the Georgian Parliament declared a state of emergency in the Tskhinvali and Java regions of South Ossetia on December 12, 1990. In the first days of 1991, the Supreme Council of Georgia passed a law forming the National Guard of Georgia. A few days later, Georgian troops entered Tskhinvali. In the spring of 1992 the fighting escalated, with Russian involvement. A ceasefire was agreed upon and in July 1992 a CIS peacekeeping operation began, consisting of a Joint Control Commission and joint CIS-Georgian-South Ossetian military patrols. The Georgians claimed that the Russian army helped and supplied the Ossetians several times during the conflict (Jones, 1996; Fuller, 1997, February 7). After a short war between Georgian and Russian military forces in August 2008, the region's status within Georgia is still unclear.

One of the South Ossetian separatists' initial demands was unification with the autonomous region of North Ossetia. There were two important aspects to the conflict which affect Georgia-Russia relations. The first was the potential threat that South Ossetian independence and autonomy demands could spill over the border and create problems for Russia in North Ossetia. Russia was very concerned about finding a solution to this problem and had tried to slow down migration from South to North Ossetia by giving South Ossetians Russian citizenship, colloquially called "passportization." The introduction of a visa system with Georgia allowed the residents of Abkhazia and South Ossetia to travel freely to Russia (Kandelaki, 2003, February 7; Torbakov, 2003). The other aspect of the South Ossetian conflict was South Ossetia's proximity to Chechnya and the Pankisi Gorge. The proximity of Georgian forces to South Ossetia and its capital Tskhinvali created anxiety and tension in the region.

Tbilisi and Tskhinvali have been in confrontation since the 1991-1992 conflict. Although there was no pact to define South Ossetia's political relations with Tbilisi, the conflict remained frozen until President Saakashvili announced that he would try to re-establish Georgia's territorial integrity. When President Saakashvili tried to repeat the Adjara solution (Areshidze, 2004) in South Ossetia by exerting economic pressure on the regional leadership during the Summer of 2004 (Tbilisi took action to curtail the smuggling of Russian goods to Georgia via South Ossetia and extended humanitarian assistance to Ossetian villages), an armed confrontation occurred between the two sides which resulted in the creation of a Joint Peacekeeping Force to keep the two sides apart.

Russia got involved in the dispute as well. Initially it used its influence within the Organization for Security and Cooperation in Europe (OSCE) to prevent Georgia from organizing an international conference on the issue and expanding the OSCE monitoring efforts in the region. Later, representatives from Russia and Georgia came together to form the Joint Control Commission. However, the South Ossetian problem remained a sticky issue between Georgia and Russia (Devdariani, 2004, November 3).

Unlike South Ossetia, Abkhazia held the status of an Autonomous Republic under Soviet rule and thus had a stronger sense of sovereignty and independence. Furthermore, the Abkhazian call for autonomy or separation from Georgia was not a post-independence issue. Abkhazia was incorporated into the Russian empire in 1810 as a protectorate and was finally annexed in 1864. Many Abkhaz fled and many Russians and Georgians arrived in the years which followed. After the Bolshevik revolution in Russia, Abkhazia gained a measure of autonomy until Stalin incorporated it into Georgia in 1931. Georgian became the official language and the Abkhaz language and cultural rights were suppressed. Many Georgians were settled there. However, this repression eased substan-

tially after Nikita Khrushchev came to power in the Kremlin (Hosking, 1992, p.326-362).

The conflict in Abkhazia between the Abkhaz and the Georgians has continued for centuries, with each group accusing the other of victimization and discrimination. In 1990 the Abkhaz Supreme Soviet attempted to upgrade Abkhazia to a full Union Republic, but the Georgian Parliament annulled this. When Georgia became independent, supporters of a break with Georgia and either independence or closer ties with Russia became more active. Tension rose and, in 1992, Georgia sent troops to enforce the status quo (Schmidt, 1993). In late 1993, Georgian troops were driven out amidst fierce fighting. Abkhazia declared independence early in 1994, but it has never been recognized as independent. An economic embargo was put in force, leaving Abkhazia isolated from all but Russia, which, until the 2008 August War, maintained a border crossing and reopened the railway line to Sukhumi. Russia further infuriated Georgia by making it easy for Abkhazians to gain Russian citizenship (the second case of "passportization").

Between 2000 and 2004, Russia did not recognize Abkhazia as an independent state, but 75% of Abkhazia's residents were given Russian passports and received Russian pensions, which also helped the region's economic development. Analysts argued that Russia was keen to keep its foothold in Abkhazia to maintain leverage over Georgia and over the strategically important South Caucasus, especially while the United States was trying to expand its presence in the region. The Russian threat to halt all economic aid to Abkhazia (which depended largely on cash from Russia) slid into potential crisis when opposition leader Sergei Bagapsh won the Abkhaz presidential election of October 2004. Russia's Foreign Ministry spokesman, Alexander Yakovenko, even indicated on 12 November 2004 that Russia could intervene in Abkhazia if the post-election violence in the region continued ((Mackedon, 2004; Fuller, 2004; Blakov, 2004).

The Abkhazian and South Ossetian problems seemed to be frozen until President Saakashvili launched a drive to re-establish Georgian territorial integrity in 2004. The re-establishment of Tbilisi's control over Adjara and the forcing of Aslan Abashidze, the authoritarian leader of the region, from power gave the Georgian President more hope and courage in dealing with the other two renegade regions.

However, developments in Abkhazia and South Ossetia demonstrated once again that the Abkhazia and South Ossetia cases were quite different from the Adjaran case. Overall, the most difficult issue that the Saakashvili Administration (which came to power after the 2003 Rose Revolution that forced Eduard Shevardnadze from the Georgian presidency in November 2003) had to deal with was Georgia's territorial integrity.

Saakashvili appeared determined to restore Tbilisi's control over Abkhazia and South Ossetia. The government's attempts in the summer of 2004 to apply the Adjaran solution in South Ossetia failed and even brought the two sides to the edge of armed confrontation, also creating tension between Georgia and Russia. Thus, analysts argued that unless the USA got more involved in the South Ossetia and Abkhazia conflicts, they were unlikely to be solved in a short term period. In this matter, the West gave strong support to Georgia during and after the Rose Revolution, but it was still not very clear whether the West was ready to risk confrontation with Russia, which sought to preserve the status quo and kept the Georgian conflicts 'frozen' (Devdariani, 2004, September 21; Miller, 2004).

1.3. The War in Chechnya and the Pankisi Gorge

Up until this date, the Chechen conflict has long been a powerful irritant in Georgia-Russia relations. Russia has continuously accused the Georgian leadership of letting military supplies to Chechnya pass through Georgia. Furthermore, Russia claims that Tbilisi turns a blind eye to Chechen fighters setting up bases in Georgia's Pankisi Gorge.

At the beginning of the 21st century, Russian President Vladimir Putin declared that the spread of international terrorism into Georgia may pose a threat to the security of Russia's southern borders. He argued that Russia had the right to widen its search for terrorists into Georgian territory. Thus Russia announced that it wanted to conduct a joint operation with Georgia against Chechen fighters in the Pankisi Gorge. Georgia continuously denied the Russian accusations and claimed that, in fact, the Russian military bases in the South Caucasus were the ones mostly involved in the transfer of weapons into Chechnya, not the Georgian ones. Georgia consistently turned down Russian requests to deploy Russian forces on the Georgian side of the border (Pravda, 2002; Khaburdzania, 2003; News From Russia, 2003).

At the beginning of the second military operation against Chechnya in 1999, Russia applied to the Georgian government for permission to use the Vaziani military airfield and other Russian bases in its operation against Chechnya. Georgia didn't accept this proposal and said that it favored the deployment of international observers from both the UN and OSCE along the approximately 80km Chechen part of the Georgian-Russian border.

In the summer of 2002, Russia once again threatened to send its troops into the Pankisi Valley against Chechen rebels, arguing that Georgia was unable to do so. One thousand Georgian troops were then deployed to the region in late August 2002, after a further escalation of ten-

sion between the two countries, when Georgia accused Russian jets of bombing the Pankisi valley.

In September 2002, Putin argued that, in accordance with Article 51 of the UN Charter (related to the right to self-defense), Russia could attack Georgia if Georgia failed to secure its international border. Consequently, when the two sides called a truce in October 2002, Georgia decided to extradite and arrest some Chechen fighters to appease Russia. Another meeting took place between Shevardnadze and Putin in March 2003. After the Rose Revolution in November 2003, Georgia seemed to re-establish its control over the region, but the area remained a safe haven for terrorists (German, 2004).

This issue was one of the main points of discussion between Presidents Saakashvili and Putin during Saakashvili's visit to Russia in February 2004, after his election as President a month earlier. During the visit Saakashvili suggested to Putin that they join forces in enhancing security along the border and making it impenetrable to Chechen fighters. They agreed on the exchange of intelligence on terrorists. Although this was not Georgian's first offer to work together on this issue, it renewed hope of an improvement in relations.

The Georgian-Russian *rapprochement* created some anxiety among the Chechen refugees in the Pankisi Gorge, leaving them feeling increasingly insecure. Russia's talk of pre-emptive strikes against suspected terrorist bases in other countries in the post-Beslan era (the three-day hostage-taking at Beslan School in North Ossetia took place in early September 2004) once again scared Georgia. Tbilisi started looking for international allies who would support its position in the Pankisi Gorge. The Georgian authorities could not get clear support from the West, although major Western countries actively backed the Rose Revolution which catapulted Saakashvili into the presidential suite.

1.4. Russian Companies' Monopoly over the Georgian Energy Sector

The Russian companies' monopoly in Georgia's energy sector caused Georgia serious concern. The Georgian government suspected that Russia was using Georgia's energy dependence as a means of trying to force Georgia to pursue pro-Russian policies. Russia's cutting of natural gas supplies to Georgia on New Years Day 2001 was the best example of this. Russia argued that the periodic cuts were a response to Georgia's unpaid gas bills, though this may not have been true in all cases.

The appointment of Kakha Bendukidze – the former head of Russia's largest manufacturing company, United Heavy Machinery – as Georgia's Economic Minister in June 2004 must also be mentioned here. In his first declaration of his policy priorities, Bendukidze specified that opening up Georgia's economy to competition and investment was his number

one goal. This strategy helped Russian companies, especially in the energy and transport sectors, to get involved even more intensively in Georgia's economy. In the meantime, Georgian Prime Minister Zurab Zhvania, in order to encourage Russian investors, declared in May 2004 that advisors from the Russian Ministry of Economic Development would help Georgia amend its tax code (Blagov, 2004, June 3).

In August 2003, RAO Unified Energy Systems, the Russian electricity monopoly, purchased a 75% stake in AES-Telasi, a joint venture which belongs to Georgia, from AES Silk Road. Aeroflot also held talks about buying the Georgian national airline, Airzena. During his meeting in July 2003 with then Georgian President Eduard Shevardnadze, the former U.S. Secretary of State, James Baker, expressed his country's dissatisfaction at the presence in Georgia of Russian energy companies like Gazprom and UES (Pravda, 2003, January 25; Pravda, 2003, August 19).

The implicit dangers of Georgia's electric system dependence became obvious again on August 18, 2003, when disruption to a transmission line switched off the entire country. Government officials claimed sabotage. But opposition politicians accused President Eduard Shevardnadze of betraying his citizens by allowing Russian energy companies decisive influence over Georgia's electricity supply. Russia's electricity monopoly took a controlling interest in Georgia's power plants on August 6, 2003 of the same year, a few weeks after a Moscow-based natural gas giant won the right to upgrade and manage pipelines through Georgia (Baran, 2003).

However, there had been some attempts to re-balance this situation in Georgia. In September 2004, a proposal to restrict the selling of more than 25% of the total shares of any Georgian state-run facility to foreign state-owned companies was approved by the Parliamentary Committee on Economic Sectors (Khutsidze, 2004). The basic aim of the proposal was to restrict the participation of particular companies (like Russian state-run energy giants Gazprom and Unified Energy Systems) in the privatization process that had just gotten underway, so as to prevent Georgia suffering continued direct energy dependence on Russia. However, there were also serious concerns that this attempt would hinder the Economy Ministry's broader privatization program.

The issue of Georgia's dependence on Russia continued to be viewed differently by various experts in both Georgia and Russia. Some Georgian experts thought that the main motivation for Russia's involvement in Georgia was political rather than economic, intended to balance U.S. influence in the country. On the other hand, some Russian experts argued that this was an inevitable price Tbilisi had to pay to gain Russian support in its efforts to protect Georgia's territorial integrity.

1.5. The Export of Caspian Oil and Gas

Another area of concern between Georgia and Russia was Georgia's deviation from the Russian position with respect to the export of Caspian oil and gas. Georgia was already a participant in the U.S.-backed Baku-Tbilisi-Ceyhan oil pipeline project, which aimed to reduce Russian influence in the region by diverting oil and, later, gas, around it. Georgia was important because without its involvement (given that it is strategically located on the East-West energy corridor and has common borders with Russia, Turkey, Azerbaijan, and Armenia) none of the Western oil or gas pipeline projects could be realized (Aras, 2002, p. 14, 33, 34, 48; Cohen, 2003, January 9; Cohen, 2004, January 23).

However, an interesting development took place during President Saakashvili's visit to Russia on February 10-12, 2004. He declared that if Russia wants to build an oil pipeline through Georgia (passing from Novorossiysk, along the Black Sea Coast to Georgia via Abkhazia), Georgia would be ready to support it (Welt, 2004). This proposal was important for various reasons. First, the pipeline would have had to pass through the problematic area of Abkhazia and there would thus be a need for a pact to determine the area's status. Second, it would have been a parallel line to Baku-Tbilisi-Ceyhan, which would have likely pleased Russia as well. The response to the proposal from the Russian side remained vague. It seemed Russia was not then directly opposing the Baku-Tbilisi-Ceyhan oil pipeline as it was initially. Russia's ultimate reaction and the sincerity of the Georgian proposal were never tested as the relations between the two countries soured quickly in the following months of 2004.

II. Russia's General Approach towards the Former Soviet Republics

An analysis of the main reasons and parameters of the tension in Georgian-Russian relations during Putin's first mandate (2000-2004) would not be complete without an understanding of the deep, underlying motives for Russia's behavior. The main motivation behind Russia's behavior towards the states which have emerged on the geopolitical territory of the ex-Soviet Union was the centuries-old imperial mentality of Russians, particularly that of their political and military elite, who tended to pursue their country's national interests at the expense of those of other states (Brannon, 2009, p. 67-72).

Not only did negative psychological emotions determine Russian behavior, but strategic geopolitical considerations as well. These considerations were linked to the desire to renew the old Empire's military and industrial complex, the preservation of traditional demographic resources in the national groups of the Empire for the formation of the armed forces and the conservation of strategically important territories

for the maintenance of Russia's great power status . It is important to keep in mind that, in those years of political and economic renaissance – thanks to the growing price of energy resources – the restoration of the Russian empire was a national ambition (Cheterian, 2009, p. 162-75)

An armed conflict between Georgia and Russia, the possibility of which was not ruled out during those years due to the strengthening of imperialistic tendencies in Russian foreign and military policies, would have had very negative consequences not possible to predict then. Since its independence, Georgia's foreign policy has been largely shaped by Russian interests in the region and its role as a mediator in ethnic disputes within the country. Russia's designation of the Trans-Caucasus as a 'zone of vital influence' explained its decision to intervene in Georgia's internal affairs (Cornell, 2000, p. 120-134).

On the other hand, the presence of ethno-political conflicts, political instability and underdeveloped political institutions, weak economic structures and economic dependence on Russia left Georgia – even after the election of Saakashvili as President – still very vulnerable to Russian pressure and manipulation.

Conclusion

Georgia's Rose Revolution forced Russia to re-examine its foreign policy towards its so called "Near Abroad." Concerning Georgia, two main viewpoints prevailed in Russia: one held that Russia did not stand to benefit from geopolitical competition with the U.S. in the South Caucasus and Central Asia, and thus had to be more accommodating of its "Near Abroad" countries, using its influence – "soft powers" – to promote *rapprochement* between Tbilisi, South Ossetia and Abkhazia. The second viewpoint was that President Saakashvili was an opponent of Russia and thus Russia should do nothing to stabilize his administration. Immediately after Saakashvili's election as Georgian president on January 25, 2004, Russia's stance on Georgia become much more assertive and the Kremlin at times resorted to outright provocations against Tbilisi, always haunted by the specter of losing its former empire. The Putin Administration lost no time to specify its intention to extend its power over the former Soviet area, sending the signal that it continues to test the geopolitical loyalty of Georgia.

In that context, it was also important for Georgia to get clear signals from the U.S., that it remained committed to the region's independent economic and political development and would not let Russia manipulate former Soviet republics as it wished.

Furthermore, the new developments in Georgia forced the Saakashvili Administration to re-examine Georgia's relations with Russia by taking into consideration various factors which had previously shaped

relations between the two countries. In the new situation, whilst indulging in brinkmanship, President Saakashvili seemed to favor improved Russian-Georgian relations. At that time some crucial questions arose: how willing would Saakashvili be to rely on the West to help resolve Georgia's problems with Russia; would he be able to balance relations with the West and Russia; how much would the West be willing to support Georgia at the expense of its relations with Russia?

If we take into consideration the developments between the West, Georgia and Russia after the Beslan School tragedy, it seems that the West did not want to throw its political – and much less, military – weight behind Tbilisi's efforts to reach its strategic objectives. Thus, what became decisive in terms of Georgia-Russia relations were mainly the political initiatives of the administrations of both countries and developments in both countries' relations with the regional states like Turkey, Azerbaijan, Armenia and Iran and the new regional actor, the United States.

References

- Abkhazia Election Debacle Presents Russia with Difficult Choices. *Eurasianet*. (October 19, 2004). Retrieved from: http://www.eurasianet.org/departments/insight/articles/eav102004_pr.shtml.
- Aras, B. (2002). *The New Geopolitics of Eurasia and Turkey's Position*. London: Frank Cass.
- Areshidze, I. (2004, May 18). Did Russia and Georgia Make a Deal over Ajaria? *Eurasianet*. Retrieved from: <http://www.eurasianet.org/departments/insight/articles/eav051904.shtml>.
- Azerbaijani Defense Minister: Withdrawal of Russian Military Bases from Georgia Puts Caucasus under Threat. *Rosbalt*. (2002, December 17). Retrieved from: <http://www.rosbaltnews.com/2002/12/17/60751.html>.
- Baran, Z. (2003, August 18). Deals Give Russian Companies Influence over Georgia's Energy Infrastructure. *Rosbalt*. Retrieved from: <http://www.rosbaltnews.com/2003/07/07/63286.html>.
- Baranovsky, V. (1993). *Post-Soviet Conflict Heritage and Risks*. SIPRI Yearbook.
- Blagov, S. (2004, February 12). Saakashvili Makes Friends with Putin during Georgian Leader's Moscow Visit. *Eurasianet*. Retrieved from: http://www.eurasianet.org/departments/insight/articles/eav021204_pr.shtml.
- Blagov, S. (2004, June 3). To Secure Future, Georgia Banks on Russian Business. *Eurasianet*. Retrieved from: http://www.eurasianet.org/departments/business/articles/eav060304_pr.shtml.
- Blagov, S. (2004, November 15). Abkhazia Crisis adds to Russia's Political Headaches in the Caucasus. *Eurasianet*. Retrieved from: http://www.eurasianet.org/departments/insight/articles/eav111504_pr.shtml.

- Boese, W (1999, November) CFE Adapted at OSCE Summit in Istanbul, *Arms Control Today*. Retrieved from: http://www.armscontrol.org/act/1999_11/cfeno99.asp?print
- Brannon, Robert, *Russian Civil-Military Relations*, Farnham: Ashgate Publishing Ltd, 2009.
- Cheterian, V. (2009). *War and Peace in the Caucasus: Ethnic Conflict and the New Geopolitics*. New York: Columbia University.
- Cohen, A. (2003, January 9). US Officials Warily Monitor Russian Policy Debate on Caucasus. *Eurasianet*. Retrieved from: http://www.eurasianet.org/departments/insight/articles/eav010904b_pr.shtml.
- Cohen, A. (2004, January 23). Georgian Inauguration Complicates US-Russian Relations. *Eurasianet*. Retrieved from: http://www.eurasianet.org/departments/insight/articles/eav012304a_pr.shtml.
- Colin Powell: Russia Has to Remove Military Bases from Georgia. *Rosbalt*. (2004, January 26). Retrieved from: <http://www.rosbaltnews.com/2004/01/27/65454.html>.
- Cornell, S.E. (2000). *Small Nations and Great Powers: Study of Ethnopolitical Conflict in the Caucasus*. Hoboken: Routledge Curzon.
- Devdariani, J. (2004, September 20). Georgia Hunts for Friends but Comes up Short. *Eurasianet*. Retrieved from: <http://www.eurasianet.org/departments/insight/articles/eav092104a.shtml>.
- Devdariani, J. (2004, November 3). Expectations Low for Georgia-South Ossetia Talks. *Eurasianet*. Retrieved from: <http://www.eurasianet.org/departments/insight/articles/eav110404.shtml>.
- Fuller, L. (2004, November 11). Analysis: Abkhaz Standoff Turns Violent. *Eurasianet*. Retrieved from: http://www.eurasianet.org/departments/insight/articles/pp111204_pr.shtml.
- Fuller, E. (1997, February 7). The Economy Continued to Improve and Politics to Stabilise but the Status of Abkhazia and South Ossetia Remained as Unclear as Ever. *Transition*, Vol. 3, No. 2, p. 82-83.
- Fuller, E. (1995, February 15). Between Anarchy and Despotism. *Transition*, pp. 64-65.
- Georgia can't handle Pankisi Gorge. Now it's Russia's Turn. *Pravda* (2002, September 26). Retrieved from: <http://english.pravda.ru/main/2002/09/26/37290.html>.
- German, T. (2004, January). Faultline or Foothold? – Georgia's Relations with Russia and the USA. *Conflict Studies Research Centre*, pp. 4-5.
- Goldenberg, S. (1994). *Pride of Small Nations*. London: Zed Publications.
- Hosking, G. (1992). *A History of the Soviet Union-1917-1991*. London: Fontana Press.
- Jones, S.F. (1996, October). Georgia's Return from Chaos. *Current History*, Vol. 95, No. 603, p. 340.
- Kandelaki, G. (2003, February 7). Abkhazia Row with Russia Deals New Blow to Georgia's Shevardnadze. *Reliefweb*. Retrieved from: <http://www.reliefweb.int/w/rwb.nsf/9ca65951ee22658ec125663300408599/437d78ac5c19706449256cc90018daff?OpenDocument>.
- Khaburdzania, V. (2003, January 30). Georgia's Key Security Concerns: Pankisi and Abkhazia. *Nixon Center*. Retrieved from: <http://www.nixoncenter.org/publications/Program%20Briefs/vol9no1khazb.htm>.

- Khutsidze, N. (2004, September 25). Barriers Proposed for Foreign State-Run Companies in Georgian Privatization. *Civil Georgia*.
- Mackedon, J. (2004, October 31). Latest Developments in Abkhazia Hint at Russian Intervention. *Eurasianet*. Retrieved from: http://www.eurasianet.org/departments/insight/articles/eav110104_pr.shtml.
- Miller, E.A. (2004, November 22). Georgia's Rose Revolution: Momentum and Consolidation. *Eurasianet*. Retrieved from: <http://www.eurasianet.org/departments/insight/articles/eav112204a.shtml>.
- Mukhin, V. (2000, December 9). Tension still Strong between Russia, Georgia. *The Russian Journal*. Retrieved from: <http://therussiajournal.com/index.htm?obj=3985>.
- New From Russia (2003, May 7). Georgian State Security Minister Refutes Al-Qaeda bases in Pankisi Gorge. Retrieved from: <http://newsfromrussia.com/world/2003/05/07/46709.html>.
- OSCE Charter for European Security, Istanbul. (1999, November). Retrieved from <http://www.osce.org/docs/english/1990-1999/summits/istachart99e.htm>.
- Pravda (2002, September 26). Georgia can't handle Pankisi Gorge. Now it's Russia's Turn.' Retrieved from: <http://english.pravda.ru/main/2002/09/26/37290.html>
- Pravda (2003, January 25). Russia Resumes Energy Supplies to Georgia. Retrieved from: <http://english.pravda.ru/world/2003/08/19/49385.html>.
- Pravda (2003, August 19). UES not responsible for Georgia's Energy Problems. Retrieved from: <http://english.pravda.ru/world/2003/08/19/49385.html>.
- Schmidt, U. (1993, July). Georgia after the Fall, *Swiss Review of World Affairs*, p. 10.
- Schmidt, U. (1992). War in the Caucasus. *The World Today*. Vol. 48, No. 12, pp. 214-215.
- Shanin, T. (1989, July 3). Ethnicity in the Soviet Union: Analytical Perceptions and Political Strategies. *Society for Comparative Study of Society and History*, Vol. 31, No. 3, p. 415.
- Shukman H. (Ed.). (1988). *The Blackwell Encyclopedia of the Russian Revolution*. (N.Y.: Blackwell Reference Ltd).
- Situation with Russian Military Base in Gudauta can be Settled only Through Concessions from Georgia. *Pravda*. (2001, July 3). Retrieved from: <http://english.pravda.ru/cis/2001/07/03/9190.html>.
- Torbakov, I. (2003, December 1). Russia Turning up Pressure on Georgia. *Eurasianet*. Retrieved from: <http://www.eurasianet.org/departments/insight/articles/eav120103.shtml>.
- Torbakov, I. (2004, January 28). Moscow Views Military Withdrawal Issue as Litmus Test for Georgian-Russian Relations. *Eurasianet*. Retrieved from: http://www.eurasianet.org/departments/insight/articles/eav012804_pr_s.html.
- UES not responsible for Georgia's Energy Problems. *Pravda*. (2003, August 19). Retrieved from: <http://english.pravda.ru/world/2003/08/19/49385.html>.
- Welt, C. (2004, March 9). A Georgian-Russian Pipeline: For Peace or Profit? *Eurasianet*. Retrieved from: http://www.eurasianet.org/departments/business/articles/eav030904_pr.shtml.
- Yamskov, A.N. (1991, October). Ethnic Conflict in the Transcaucasus. *Theory and Society*, Vol. 20, No. 5, pp. 634-635.

Sociology

„მკვლელი“ ღვედები, ქალი მძღოლები და დაბურული მინები: პრობლემები სომხეთში უსაფრთხოების ღვედების შესახებ კანონის შემოღებასთან დაკავშირებით

მატოსიანი ტიგრანი

სომხეთის სახელმწიფო უნივერსიტეტი

2009 წლის აგვისტოდან, სომხეთის მთავრობის ინიციატივით, მთელს ქვეყანაში უსაფრთხოების ღვედის ტარება სავალდებულო გახდა, საჭირო განათლებით თუ ცნობიერების ამაღლებისათვის აუცილებელი ღონისძიებებით უზრუნველყოფის გარეშე. მიუხედავად იმისა, რომ ღვედის გამოყენება მნიშვნელოვნად გაიზარდა ქვეყანაში, რჩება ცნობიერებასთან დაკავშირებული წინააღმდეგობები, ასევე კულტურული დაბრკოლებები, რომელიც სერიოზულ საფრთხეს წარმოადგენს პოლიტიკის ეფექტური განხორციელების მიმართულებით. აქედან გამომდინარე, სტატია გვთავაზობს, დაინტერესებულმა მხარეებმა ერთდროულად მოახდინონ რეაგირება მძღოლების არასწორ და ღვედის ტარების ნეგატიურ აღქმებთან დაკავშირებით, რაც სათავეს იღებს საზოგადოების აღნიშნული ჯგუფის მიერ ვაჟკაცობისა და ვაჟკაცური საქციელის გაგებიდან.

“Killer” Seat Belts, Feminine Drivers, and Tinted Windows: Pitfalls on the Way of Enforcement of Seat Belt Rules in Armenia

Tigran Matosyan
Yerevan State University

This article is based on the results of a research implemented in the scope of CRRC-Armenia Research Fellowship Program, financed by Carnegie Corporation of New York.

At the meeting of the Armenian Government on 13 August 2009, Prime Minister Tigran Sargsyan expressed his concern regarding the high mortality rates on the roads of Armenia, described the practice of drivers not to buckle up as ‘vainglory,’ and ordered the Police to fully enforce the requirement of Armenia’s traffic rules to wear seat belt (Meloyan, 2009). As part of the Action Plan within the National Strategy of Road Safety adopted on the same day, the Road Police embarked on penalizing the offenders of the seat belt rules, now not only on the highways outside of town (as it had been the case since approximately 2007-2008) but also in capital Yerevan and other urban areas of the country; the fine was defined in the amount of approximately \$13 (Gevorgyan, 2009).

Research data collected from different countries suggest that enforcement in the form of punishment usually proves efficient for changing driving related safety behaviors in combination with public information campaigns and other measures tailored toward building internal justifications for concerned people (Pasto & Baker, 2001; Thyer & Geller, 1990; Kumpfer & Pett, 2001; Hagenzieker, Bijleveld, & Davidse, 1997; Petridou et al., 1999; Akhmadeeva et al., 2008). However, the policy of administrative enforcement in Armenia has not been preceded or accompanied by serious awareness building initiatives.

The fact the number of motorists wearing seat belt after the adoption of the Strategy has increased fundamentally especially in Yerevan (where approximately one third of Armenia’s population is concentrated) and the fact that the Police vows to be consistent in enforcing the seat belt rules pose a question as to the necessity of intrinsic incentives at all. In other words, aren’t measures of consistent administrative enforcement in the form of monetary penalty sufficient to make the use of seat belt in Armenia irreversible?

I argue that despite the evident breakthrough, a more careful look into the situation reveals the flaws of the policy of enforcement which has failed to integrate into its frames an effective public information cam-

paign. More specifically, I suggest that in order to ensure a substantial change and sustainability in seat belt use behavior in Armenia, state or/and concerned non-government organizations should simultaneously initiate measures toward creating internal incentives by a) addressing lack of knowledge and misperceptions of drivers in a number of specific safety-related issues and b) neutralizing negative perceptions around the practice of wearing seat belt that derive especially from cultural definitions of masculinity and masculine behavior. Otherwise, possible decrease in the control over compliance with the seat belt regulations is fraught with the risk of relapse of the practice of nonuse as it has already been registered in a number of cases.

Conclusions of the article are based on a survey conducted before the adoption of the Strategy, in April-July 2009, among 400 active drivers in capital Yerevan, in Vanadzor, administrative center of Lori province in the north of Armenia, and in the urban-type community of Metzamor located west of Yerevan. The survey was supplemented by interviews (30), focus groups (3), as well as monitoring and observations of driver behavior on the roads both before and after the adoption of the Strategy. Non-probability sampling methods with purposive selection of as representative samples as possible were applied for the study.

The Factor of Unawareness

As an old joke on seat belts goes, a man in Yerevan sees his friend belted up in the car and asks him with derision: "Don't you have three rubles to give to the police officer and not to tie yourself up like a monkey?" (The words "monkey" *kapik* and "to tie up" *kapkpel* have similar pronunciation in Armenian which adds to the humor of the joke.)

The general disregard toward the seat belt as a safety device implied in the joke once popular in Soviet Armenia has retained its relevance also to present days. I will try to show in this part of the article that measures of administrative punishment currently applied in Armenia should be combined with efficient awareness-raising efforts since results of the study indicate that more than half of the Armenian motorists unwilling to use seat belt before the Strategy could be characterized as being in the state of unawareness with respect to their own problem behavior.

US professors of psychology James O. Prochaska, John C. Norcross, and Carlo C. Diclemente, authors of the acknowledged model of successful self-change in psychotherapy, call such people 'precontemplators' who before proceeding to the next stages of self-change (i.e. contemplation, preparation, action, maintenance, and termination) should be helped to become conscious of their problem behavior as well as the defenses they use to justify it (1994, pp. 89-108). Otherwise, action, as the authors argue, will have a little lasting effect as it has been the case with numerous

action-oriented techniques without awareness behind them. (Prochaska, Norcross & Diclemente, 1994, p. 115).

Since the working hypotheses of this study held that unawareness was one of the factors determining nonuse of seat belt in Armenia, the survey was designed in view of the necessity of validating or disproving existence of this variable. More specifically, the first cluster of survey questions was aimed at establishing different aspects of awareness regarding the necessity of using seat belt: respondents were asked if they believed seat belt could save lives and prevent serious injuries, if seat belt could kill and cause injuries during accidents, if seat belt should be used inside or outside of cities, and if the drivers thought use of seat belt was a matter of personal choice or public necessity.

The first group of precontemplators included those motorists who a) thought that seat belts were not useful in protecting from injuries and fatalities and b) who thought that wearing seat belt imposed various threats to life of the driver.

Thus, 15.5 percent of respondents disagreed or partly disagreed with the statement "In general, seat belt can reduce fatalities during car accidents by more than 50 percent." The second subgroup of drivers had skeptical opinion toward the practice of wearing seat belt on the grounds that it carried dangers for drivers. When asked to express their agreement/disagreement regarding the statement "Seat belt can increase likelihood of fatalities during car accidents," 8.2 percent of respondents agreed and 14.7 percent partly agreed with it.

Prochaska et al. note that denial, justification and rationalization are the weapons of precontemplators by the medium of which they oppose the attempts directed at solving their problematic behavior. The motorists included in the first group of precontemplators seem to fit into the category of deniers and rationalizers, and the following answers obtained during interviews personify the ways they use the denial of necessity to wear seat belt and justification/rationalization of the choice not to do so: "I do not believe seat belt can help during a car crash. If a tragedy is to happen, it will happen anyways, and no seat belt can be of help." (male driver, Yerevan, above 60) As another driver said, "I am not sure seat belt can help me if my car hits any other object with a strong force. Let them show me a scientific material, proving that seat belt really saves lives; then I may be persuaded." (male driver, Yerevan, 18-25)

In the examples below seat belts are depicted as a cause of fatality during automobile accident:

Seat belts are dangerous. If my car flies down the precipice, I will have no time to unfasten myself and jump out. The same is true for the

fire. If my car catches on fire in an accident, I may not be able to get off the car in time. (male driver, Yerevan, 46-60)

I do not use my seat belt because it is not safe; if my car, for a reason, falls into a river, and if I am fastened, I will drown with my car, not having enough time to leave it. (male driver, Vanadzor, 46-60)

It is interesting that a study of attitudes toward seat belt conducted in neighboring Georgia in October-November 2007, reveals a number of striking similarities between the answers of Armenian and Georgian respondents. One of such similarities refers to the ways of justification of nonuse of seat belt. The threats of drowning and driving down off the road have been mentioned by some Georgian interviewees as reasons making seat belt look less reliable (Partnership for Road Safety, 2007, pp. 15-16).

Unawareness along with the attitudes of denial and justification can also partly account for the fact that 7.2 % of the surveyed drivers in Armenia did not have seat belts in their cars at all (before the adoption of the Strategy, there used to be car service centers and car technicians in capital Yerevan and other regions of Armenia who were specialized in removing seat belts or silencing seat belt alarm signals in the cars by using different adjustments). The recount of a participant of one of the focus groups (female driver, Yerevan, 18-25) is a good example in this regard: "When we bought our new car, I was surprised to hear my father say to me that there were several urgent modifications to be made on the car, and one of them was the removal of the seat belt as a redundant object".

The second and largest group of precontemplators is comprised of motorists, who accepted the necessity of using seat belt on the highways out of towns but not on the roads inside, despite the considerable number of car accidents and victims in capital Yerevan and other major towns of Armenia.

Results of the survey provide an insight into the level of misperceptions of motorists right prior to the adoption of the Strategy and enforcement of seat belt regulations in urban areas of Armenia. When asked "In which of the following cases have you used seat belt during the past 12 months?" 69.9 percent of respondents for whom practice of wearing seat belt was not permanent had used it only on the highways outside of cities. Additionally, when asked "In which of the following cases (urban areas, highways outside of the cities) do you think there is a need to fasten seat belt to ensure the safety of the motorist?" 56.6 percent answered that seat belt was necessary only on the highways outside of cities.

During the interviews, drivers disagreeing with the need to fasten seat belt inside towns were bringing several main arguments to substantiate their position: low speed of road traffic, short-distance and short-

term trips in the cities, as well as inconvenience of using seat belt in view of weather conditions in the summer:

Seat belts are needed on the highways where the speed is high; inside the cities their use is meaningless as the speed is too low. Even if a collision happens in the city, you can protect yourself from injury by simply holding firmly on to the wheel or resting against the dashboard. (male driver, Yerevan, 26-35)

A crash that happens to the cars moving at the speed of 30 km/h is not dangerous at all. Now, imagine I have to make multiple short distance trips in Yerevan; it will be very inconvenient to fasten the seat belt and undo it each time I get in and off the car... But I agree that seat belt should be used on the highways. (male driver, Yerevan, 36-45)

It is noteworthy that a great deal of surveyed respondents also demonstrated unawareness with respect to the operating seat belt regulations in the country. Only 28.8 percent of drivers agreed with the statement that the law envisaged warning and fine for not using seat belt in urban areas. This fact should be also attributed to the situation prior to the adoption of the Strategy when the Road Police had been enforcing seat belt regulations only on the highways outside of cities.

A confident assumption can be made that application of seat belt regulations to the urban areas can strongly impact the driver perception of the requirements of the law, however not necessarily bring about substantial change of perceptions regarding the necessity of using seat belt inside cities as a means of drivers' security. Media reports, observations, as well as a number of interviews conducted after the application of the law in the urban areas attest to this proposition. The patterns of unawareness-related answers that had been registered before the application would frequently recur also after it. As a male taxi driver in Yerevan (26-35) mentioned during the interview,

The government started enforcing this law without having an understanding what the seat belt is. The seat belt is intended to protect people from the inflating airbag; it can not save lives without the airbag. Besides this, a taxi driver can be easily robbed at night with the seat belt on. He can escape nowhere.

Another female driver (36-45) referred to the argument of short-distance trips: "I am not sure I need the seat belt while driving in Yerevan. My work place is only 5 minutes away from my house by car. Can anything happen to me during those short and low-speed trips?"

Besides the two forms of precontemplation mentioned above, it became possible to spot one more expression of seatbelt-related unaware-

ness. More specifically, the survey intended to establish the opinion of drivers on the issue of social responsibility, in other words, to reveal if drivers thought use/nonuse of seat belt could impact only an individual driver or the society in general. Respondents were asked to express their agreement/disagreement with the following two statements: "The state should enforce usage of seat belt as it is a matter of national significance" and "Use or nonuse of seat belt is a matter of personal choice, and the state should not oblige drivers to wear it". The answers showed that 32.4 percent of motorists thought that use of seat belt was not a matter of national significance (3.1 percent disagreed with the statement partly). Similarly, 37.8 percent of respondents agreed that use of seat belt should be left at the discretion of the driver, not the state (16.2 percent agreed with the second statement partly).

It should be also noted that cross-tabulation of data became only partly supportive of the assumption that unawareness could be conditioned by the age and education variables. For example, 65.7 percent of the respondents who believed that seat belt increases fatality during accidents were below 35 years of age; however, 61.5 percent of them had higher education (this might be explained by the factor of social desirability as in several cases respondents with secondary education were recognized to be posing themselves as having higher education).

Negative Perceptions

I argue that the second major and more influential problem the government has to address along with enforcement of seat belt regulations is the set of negative cultural perceptions felt by the motorists with respect to the practice of wearing seat belt. Otherwise, the measures of administrative control, should they deteriorate, carry the risk of relapse of massive nonuse of seat belt under the impact of these perceptions.

The first reason for such proposition is the fact that before the adoption of the Strategy, a considerable portion of drivers, who had not worn seat belt at all or who had worn it occasionally (only on the highways), acknowledged the necessity of using seat belt. For example, 37.7 percent of such drivers were of the opinion that seat belt should be used both in town traffic and outside of towns; 53.8 percent agreed and 31.8 percent agreed partly with the suggestion that seat belt can reduce fatalities by more than 50 percent during accidents; 39 percent of respondents agreed and 22.2 percent agreed partly that the use of seat belt was an issue of state significance.

According to the self-change scale offered by Prochaska et al., these drivers most probably belong to the stage of "contemplation", which denotes acknowledgment of the problematic behavior by the person and still lack of determination to terminate it (1994, pp. 41-42). At the begin-

ning of the study, the working hypothesis suggested that apart from the unawareness factor, negative, especially masculinity-related, stereotypes were the second major determinant accounting for nonuse of seat belt among drivers who recognized the necessity of seat belt or might have intention to start wearing it.

Not excluding the possibility of existence of other variables for non-use of seat belt either, the survey asked respondents questions with the purpose to reveal dominant societal attitudes toward the practice of wearing seat belt. More specifically, one of the questions asked respondents to mention maximum three factors (in the list of eight) which, according to their opinion, were the most significant obstacles for drivers in Armenia for using seat belt. As it was expected, "Derisive attitude of the society toward the users of seat belt" became the most frequently mentioned factor (53.1 percent) followed by "Confidence of motorists that no accident will happen to them" (48 percent), "Inconvenience of using seat belt" (45.4 percent), "Level of knowledge of motorists on the benefits of using seat belt" (42 percent), "Ineffective work of the road police" (37.1 percent), "Fear of looking different in the eyes of the public" (30.8 percent), "Absence of seat belts in the cars" (25.1 percent), and "Low amount of penalty" (18.3 percent).

Cross-tabulation of variables, however, revealed the fact that difference between the number of contemplators and precontemplators who were aware of and therefore could be exposed to existing negative societal perceptions was not big: for example, 51.9 percent of respondents, who did not use seat belt but thought that state should enforce seat belt regulations, mentioned 'derisive attitude of society' as a significant factor hindering use of seat belt; similarly, 40.4 percent of the respondents, who did not use seat belt and opposed the idea of state enforcing seat belt regulations, thought that negative societal perceptions were a significant obstacle for wearing seat belt.

Further, in order to specify the nature of the felt negative societal attitudes, drivers were asked "What may people most probably think about the motorist who uses seat belt in the city?" and given the option to choose maximum three answers in the list of ten. Choices made by respondents were classified into three qualitative categories: positive ("Motorist is a disciplined person" – 46.9 percent; "Motorist realizes the importance of seat belt" – 31 percent; "Motorist feels responsible for his/her family" – 12.7 percent), neutral ("Motorist is probably a foreigner" – 64.1 percent; "Motorist is afraid of being fined" – 40.6 percent; "Motorist probably works at an international organization" – 31.2 percent), and negative ("Motorist is not experienced" – 31.1 percent, "Motorist is trying to give the impression that he/she respects the law" – 20.4 percent; "Motorist is obedient by his nature" – 13.1 percent; "Motorist is not courageous" – 10.3 percent).

My assumption is that the negative characteristics of inexperience, obedience, and lack of courage are interrelated, and their origin and meaning should be understood in the context of a masculine society in which, according to the definition of anthropologists Geert Hofstede and Gert Jan Hofstede, "emotional gender roles are clearly distinct: men are supposed to be assertive, tough, and focused on material success, whereas women are supposed to be more modest, tender, and concerned with the quality of life" (2005, p. 120).

Inexperience, obedience, and lack of courage are synonymous as each of them may also denote fear, lack of confidence, or lack of independence, features that are incompatible with the culturally prescribed roles and images of the male gender in a predominantly masculine society like Armenia. Inexperience, obedience, and lack of courage may also denote lack of competitiveness, another masculine characteristic according to the definition of Richard Dyer (1997, p. 264). In the meantime, it should be noted that these negative perceptions become possible in a situation when use of seat belt is not clearly perceived as a legal requirement as was the case in capital Yerevan and urban areas of Armenia before the Strategy. It is exactly in absence of such requirement that use of seat belt is most likely to be associated with someone's inexperience, hence, fear of getting injured, killed, or even excessive submissiveness.

As one of the respondents (male driver, Yerevan, 26-35) said during the interview:

If you wear your seat belt in the city, people may think that you are a beginner; this may be an indicator of lack of your abilities. The driver may be understood as being afraid for his life. There is an important moment in the mentality of the Armenian man: even if he is afraid of something, he should not make it known to other people. Fear is not a becoming feature to a man.

Another interviewee, (male driver, Vanadzor, 26-35), who explained own nonuse of seat belt by his forgetfulness, also admitted to the existence of similar negative perceptions:

A really cool guy should be risky; he must show he is proficient. He says 'I am not that coward to use seat belt... why should I obey?' Besides this, if a passenger next to him makes an attempt to belt up, he will view it as a demonstration of mistrust toward him. Personally, I have a positive attitude toward users of seat belt; I just always forget to put it on.

Though the response "Motorist is afraid of being fined" was originally put in the category of neutral evaluations, it could be assumed that within the context of masculinity-based behavior expectations, this per-

ception also may acquire a negative tinge of meaning due to the fear factor implied in it.

That the use or nonuse of seat belt in Armenia may have the function of affirmation of one's identity as normal can be argued also on the basis of interviews and observations conducted with female drivers. According to results of the monitoring of Yerevan automobile traffic before the Strategy, 29 percent of female drivers (who constituted only 3.8 percent of total population of Yerevan drivers) were using seat belt against only 1.1 percent of the remaining male drivers. This observation was supplemented by the focus group conducted among female motorists. Its participants, both seat belt users and non-users, did not attach importance to the mentioned masculinity-related stereotypes in determining their own behavior. Rather, they attributed nonuse of seat belt in Armenia to reasons such as "lack of awareness," "low level of education of drivers," "absence of a tradition to wear seat belt," "corruption" and "absence of efficient control on the part of the state".

In the meantime, it should be noted that in a society where masculinity values are predominant, masculine behavior may tend to be reproduced by females as well. This can take place under pressure or in imitation of masculinity values. For example, a 24 year-old female motorist put straightly during an interview that she was not using seat belt because she was not a coward. Another interviewee, 38 year-old female driver, told that it was the social pressure that kept her from using seat belt:

Once I had to drive my family to the village. At the outset of our trip, I said that I wanted to wear the seat belt as I had had a bad dream the night before. At that, my uncle said that I could become subject of derision as people might think I could not drive well. I know it is wrong, but I had to listen to him.

Finally, the link between a masculine society and feminizing power of the seat belt can be seen in the mentioned survey conducted in neighboring Georgia. According to its participants, apart from positive perceptions, there were three negative characteristics attributed to the driver who regularly used seat belt in Georgia – inexperience, cowardice, and excessive decency (Partnership for Road Safety, 2007, pp. 3-5).

Apart from the masculinity stereotypes, the Armenian survey also demonstrated that the driver regularly using seat belt may be perceived as someone trying to give the impression of decency. This was reflected in the answer "Driver is trying to give the impression that he/she respects the law". As one of the interviewed respondents (male driver, Yerevan, 26-35) noted:

A person, who drives in Yerevan with the seat belt on, may be wrongfully taken for someone who has just come back from Europe or America and who wants to stand out from other “backward” drivers as a more advanced and more knowledgeable person.

It is interesting that in the space given to the respondents to fill in their own versions, some of them mentioned that drivers using seat belt regularly could be characterized by the public as overly decent. This opinion - again coinciding with the results of the Georgian survey - was reflected in the following answers: “driver is pedantic,” “driver is overly intelligent,” “driver is overly law-abiding”.

In order to better understand how the mentioned negative stereotypes may impact the behavior of motorists, it is also necessary to bear in mind that they should obviously acquire greater functionality in a collectivist society where “the bonds that link people to one other and to institutions are rigid, the individual’s freedom of choice is limited” (Yankelovich, 1994, p. 20) or where, according to another definition, “people from birth onward are integrated into strong cohesive in-groups which throughout people’s lifetimes continue to protect them in exchange for unquestioning loyalty” (Hofstede, 2005, p. 76).

Results of the study demonstrate that majority of respondent motorists can be characterized as members of a large in-group whose behavior is in conformity with the dominant norms shared by its members.

One of the indicators of inter-dependedness of motorists is the fact that in the opinion of 64.1 percent of respondents, a driver using seat belt in the town could be taken for a foreigner. This implies by itself that the practice of wearing seat belt is not accepted as an in-group norm, and the local motorist attempting to wear seat belt runs the risk of assuming the role of out-group member and being alienated from the in-group. This assumption may be supported by 30.8 percent of respondents thinking that “Fear of looking different in the eyes of the public” is a significant obstacle for wearing seat belt in Armenia.

Secondly, when asked “Which of the following changes will make you start or increase using seat belt?” motorists for whom usage of seat belt was not regular distributed their choices (again maximum 3) as follows: (1) “If the Road Police officers started wearing seat belt themselves” (63.4 percent); (2) “If control of the Road Police increased” (53 percent), (3) “If people around me started using seat belt” (43.4 percent), (4) “If the amount of penalty increased” (42.1 percent), (5) “If use of seat belt was not perceived negatively in the society” (38.1 percent), (6) “If benefits of using seat belt were advertised” (25.2 percent).

Despite it is only answers 3 and 5 that directly validate the assumption of inter-dependedness of drivers behavior, I would like to suggest that 2 and 4 pertaining to external enforcement factor may support this

idea as well, though indirectly. Based on the interviews conducted after the adoption of the Strategy, it became evident that by making use of seat belt in the urban areas a legal requirement, the state – perhaps without even suspecting it – lent a “saving hand” to the drivers in contemplation or preparation stage. According to the Prochaska scheme, these were the drivers who acknowledged the importance of seat belt or were even contemplating to start using it but could not do so (or step further into action, maintenance and termination stages) because of existing negative perceptions. Therefore, application of seat belt regulation to the urban areas has created an “excuse” for such drivers to justify their behavior. The following passage from the interview conducted with a 27-year-old male motorist in Yerevan is a good example demonstrating how the conflict between the collective pressure and individual desire is given a resolution:

I live in a tiny neighborhood where for the overwhelming majority of people wearing seat belt would be viewed as something wild and unmanly. Hence before the recent changes, use of seat belt by me would be unimaginable; I could not afford to go against the accepted norms.... Now I have a good defense: I do not want to be fined. And people seem to understand it.

Again, it is important to note that juxtaposition of different variables of the survey demonstrated that both contemplators and precontemplators can be exposed to the impact of the collectivist norms. For example, 31.1 percent of respondents, who did not use seat belt but thought that state should enforce seat belt regulations, said that change in the behavior of other people would make them start or increase wearing seat belt; similarly, 27.9 percent of respondents who did not use seat belt and opposed the idea of state enforcing seat belt regulations expressed their readiness to change their behavior under the same condition.

Finally, there were two notions in the survey which at first glance might lead to the conclusion of presence of determining variables other than unawareness and negative stereotypes. One of them refers to the stated readiness of motorists to start wearing seat belt or use it more frequently if the Road Police officers themselves started using it, the other – to the overconfidence of motorists (that no accident would happen to them) mentioned by respondents as one of the most significant factors hindering use of seat belt in Armenia. However, I would like propose that both answers are typical of the contemplation stage. The former clearly indicates that motorists do not view the practice of wearing seat belt in terms of its life saving benefits; rather, they perceive it as another legal requirement imposed from above; the second answer allows us to form an opinion about the level of fatalism that may exist among the motorists (preconditioned by lack of comprehensive information on a subject, fatal-

ism denotes a lack of effort or action because of the belief that all events are predetermined).

Premature Enforcement

Can coercive environmental alteration such as tightening of measures of administrative punishment for nonuse of seat belt bring about a change of behavior among the motorists who have not developed internal belief in the necessity of using seat belt or who still feel the pressure of in-group values? Observations carried out on several highways outside of urban areas before the adoption of the Strategy and in capital Yerevan and the town of Vanadzor after the adoption, provide us with interesting material to argue that use of seat belt by such motorists is likely to be temporary and stop once the possibility of being noticed and fined by the Road Police decreases or disappears. Moreover, various forms of behavior might be developed by them to resist the requirement of wearing seat belt even when this possibility is around.

More specifically, two weeks after the application of the law in Yerevan, a simple count on various streets during daytime in Yerevan demonstrated that the number of non-users on secondary and tertiary streets – where the control of the Road Police is much weaker – is higher than that on primary streets. Observations conducted late in the evening, at a time when control of the Road Police weakens and the darkness considerably decreases the likelihood of being seen from outside, the number of users drops further. For example, the count carried out on several primary and secondary streets in Yerevan three weeks after adoption of the Strategy demonstrated that the rate of usage during daytime, 91.7 percent, dropped to 69.5 after ten o'clock p.m.

The fact that use of seat belt not supported by internal conviction and social liberation from negative stereotypes is likely to stop in absence of external control is corroborated by another interesting reality. Monitoring carried out on weekends has revealed the fact that in most of observed cases, drivers of the cars in wedding motorcades did not use seat belt. The likelihood of a car from a wedding procession to be stopped by the Road Police is extremely low, if impossible (again for cultural reasons).

Apart from the passive forms of disobedience connected with the perception of diminished control, the drivers in Armenia might also engage in more active forms of resistance to seat belt regulations. Prochaska et al. argue that “Precontemplation indicates in many cases an active resistance to change” (1994, p. 75). In the case under consideration, it can be assumed that the motorists in contemplation stage too may resort to active forms of resistance under the in-group pressure.

Cars with tinted windows that make observation of the driver and the passengers from outside impossible are one good example of it. According to the results of monitoring conducted in Yerevan at the beginning of July (before the adoption of the Strategy), 15.4 percent of cars in capital Yerevan had tinted windows that made the observation of inside of the car impossible. Though the original purpose of tinting the car windows may be different – such as protecting inside of the car from sun rays, ensuring privacy of people inside, enhancing the appearance of the car, emphasizing a social status, etc. – some of the interviewed owners of tinted cars mentioned that they felt comfortable on highways where the Road Police could not control them.

Monitoring carried out on Yerevan-Vanadzor highway and in the town of Vanadzor further indicated that tinted windows have already become essentially functional in terms of defying seat belt regulations. First, the number of tinted cars on the highway was more than twice as many as that in Yerevan. Second, the number of tinted cars in the town of Vanadzor reached 42.4 %. This considerable difference can be explained by the fact that Vanadzor drivers travel to Yerevan more often than Yerevan drivers to Vanadzor, in other words, they more often become subject to complying with seat belt regulations. Interviews and observations indicate that after adoption of the Strategy the tinted windows have received functionality also for capital Yerevan and other urban areas.

An assumption can be made that the number of tinted cars in the capital and throughout the Republic will increase unless the state takes appropriate measures to curb the process. However, if the growth of number of cars with darkened windows can be regulated by application of administrative measures, prevention of another form of active resistance, namely, imitation of wearing seat belt, does not seem as likely without raising awareness. Closer observations on the streets of Yerevan and several highways revealed the fact that quite often motorists create an appearance of wearing seat belt for an outside viewer. In particular, this is done either by pulling the belt across the shoulder (but not across the stomach) and further down under the hand or pulling it across the stomach but not pressing the tongue of the belt into the locking part. In the second case, the belt tongue is simply laid either on the lap of the driver or next to the driver's seat; in some cases the drivers were observed to hang the tongue end of the belt on the hand brake. According to an informant, some of the drivers in Yerevan who had removed seat belts from their cars before the Strategy, started adjusting black ribbons to seat belt anchors in the cars to give the appearance of being belted-in by simply pulling and laying them over their chests.

It is interesting that current imitation on the roads of Armenia echoes the stories from the Soviet times. More specifically, it was believed that special suits, shirts, and T-shirts with ribbons making semblance of

worn seat belts were sewed in Georgia and Armenia in the 1970-80s. Similar stories of using fake seat belts were told several years ago about some local drivers of international organizations in Armenia whose internal regulations obliged all the employees to be belted up.

Finally, signaling each other by headlight beams can be considered as another form of active defiance to seat belt regulations on the highways outside of urban areas. This warning method, by which the drivers coming from opposite directions let each other know about the presence of a Road Police car nearby, according to drivers themselves, had been forgotten in Armenia long time ago and resurfaced with the authorities tightening administrative measures toward wearing seat belt on the highways since 2007-2008. According to the results of the interviews and monitoring, this type of driver behavior at present can be observed on almost all major non-urban highways of Armenia. Besides, this type of active defiance is perhaps the strongest evidence of how collectivist principles are reflected in the behavior of individuals.

The Stage of Termination

In the end of the article, I would like to support the points made so far by referring to the example of those motorists who before adoption of the Strategy were at the stage of termination on the self-change scale or who, in other words, had been using seat belt regularly. In the survey, such respondents constituted 4.4% of the total population of drivers. Before adoption of the Strategy a focus group had been conducted in Yerevan with male motorists for whom use of seat belt was a regular practice.

As it had been assumed from the start of the survey, drivers in the termination category demonstrated almost 100% conformity with what had been considered by the survey as criteria of awareness; the overwhelming majority of them opined that the most significant factors hindering use of seat belt in Armenia was unawareness and derisive attitude of the society.

However, it was the focus group which gave a clearer picture of how these motorists had reached the termination stage. They unanimously accepted that before using seat belt they had gained awareness of the necessity to do it; thereafter they had to overcome own feelings of fear and discomfort with respect to what surrounding people might think about their behavior. All of the drivers agreed that no external impact such as administrative punishment applied at that time on the highways outside of towns had played a significant role in their choice to use seat belt. As a 27 year-old participant of the focus group in Yerevan mentioned,

I became aware of the importance of the seat belt two years ago after watching a couple of social ads on YouTube. I was shocked and made up my mind to fasten my seat belt in all cases, in the town and outside of

it. Besides this, I make the passenger sitting behind me fasten the seat belt, otherwise in case of a frontal collision I myself become very vulnerable even though I am belted in... I know that there are some backward opinions about people wearing seat belt, but I do not care.

The statement of another participant, a 32 year-old driver, again demonstrates how the processes of consciousness raising and liberation from social pressure precede the stage of termination of nonuse of seat belt:

Every more or less educated person should know that seat belt can save life and protect from injuries. I traveled abroad frequently and saw people in other countries wear seat belt not only on the highways but also in the urban areas... At first, it was quite difficult to drive in Yerevan with the understanding that people watching you might think that you were a beginner or cowardly. However this feeling is passing away with time. Moreover, you obtain the feeling of a more responsible person.

It is interesting that the mentioned departure from the accepted in-group male norms in the case of permanent users can be again explained within the frameworks of the collectivism theories. More specifically, the positive correlation between economic growth on the one hand and change of societal and personal values on the other was described by sociologist Ralf Dahrendorf according to whom people feeling affluent have the power to slacken collective bonds by their enhanced individualism and personal freedom (1980). Following the affluence theory, it could be argued that the participants of the focus group were retaining higher degrees of independence from the in-group values also due to the following characteristics of economic nature: they could be considered as established professionals in their fields of work with considerably high-paying jobs compared with general standards in Armenia; they were all below 35 years of age with higher education; most of them had experience of traveling abroad.

Similar results were obtained from the survey data: 81 percent of permanent users of seat belt drove expensive or very expensive cars (the respondents were asked to mention the type of their cars); 78.5 percent were below 35 years of age, 78.8 percent had higher education.

Conclusion

I tried to argue that in order to achieve substantial results in the seatbelt-related public policy implemented by the state, current administrative measures applied by the Road Police throughout the country have to be accompanied by initiatives toward creating internal incentives for drivers.

Results of the survey, interviews, and observations have demonstrated that one of the major obstacles which had kept drivers from using

seat belt before adoption of the Strategy and which still has the potential to hinder its application after the adoption pertains to the factor of unawareness. Hence, one of the main conclusions of the article is that immediate efforts should be taken by state or/and interested non-government organizations to raise awareness of motorists on several safety-related issues. More specifically, necessity of using seat belt in the urban areas along with the highways outside of cities, consequences of nonuse of seat belt for both individual drivers and society in general should be effectively propagandized to the public.

Second major problem that the policy makers will have to tackle refers to the felt negative perceptions regarding the practice of wearing seat belt. Majority of the negative stereotypes, as it could be judged from the answers of respondents, derived from in-group perceptions of masculinity and masculine behavior and depicted the driver regularly using seat belt as inexperienced, obedient and coward. Such drivers could also be associated with persons who were pretending to respect the law or who were overly decent.

Though it was demonstrated that the recent adoption of the Strategy was a "good excuse" for the drivers acknowledging necessity of seat belt to start using it, the results of the study also suggested that both unawareness and negative stereotypes will tend to resurface and make impact under the pressure of in-group values once the external control over the observance of regulations diminished. Cases of nonuse of seat belt and active methods of defiance to the requirement to wear seat belt both in Yerevan and non-urban roads were presented to validate the assumption. Finally, an attempt was made to argue – on the example of drivers who had started using seat belt regularly before the adoption of the Strategy – that most substantial termination of the practice not to use seat belt can be achieved by efforts directed at raising awareness and neutralizing negative stereotypes.

References

- Akhmadeeva, L., Andreeva V. A., Sussman S., Khusnutdinova Z., & Simons-Morton B. G. (2008). Need and possibilities for seat belt use promotion in Bashkortostan, Russia. *Evaluation & the health professions*, 31 (3), 282-289.
- Drivers do not know that seat belts are mandatory. (2007, May 25). *Armtown.com*. Retrieved from <http://www.armtown.com/news/am/a1p20070525/49763/>
- Dahrendorf, R. (1980). *Life chances: approaches to social and political theory*. Chicago: University of Chicago Press.

- Dyer, R. (1997). Heterosexuality. In A. Medhurst & S. Munt (Eds.) *Lesbian and gay studies: a critical introduction* (pp. 261-273). London: Cassell.
- Hofstede, G. & Hofstede, G. J. (2005). *Cultures and organizations. Software of the mind*. New York: McGraw-Hill.
- Gevorgyan, S. (2009, September 1). Motorists buckle in to law: police vow "no letup" in enforcing new driving culture. *ArmeniaNow.com*. Retrieved from <http://www.armenianow.com/?action=printable&IID=1249&AID=4002&CID=3826&lng=eng>
- Hagenzieker, M. P., Buleveld F. D., & Davidse R. J. (1997). Effects of incentive programs to stimulate safety belt use: a meta-analysis. *Accident analysis & prevention*, 29 (6), 759-777.
- Meloyan, R. (2009, August 13). The government adopted the National Strategy for Road Safety. *Radio free Europe*. Retrieved from <http://www.armenialiberty.org/content/article/1798897.html>
- Pamuk, O. (2008). *Drugiye tsveta* [Other colors]. Saint-Petersburg: Amphora Publishing.
- Pasto, L., & Baker, A. G. (2001). Evaluation of a brief intervention for increasing seat belt use on a college campus. *Behavior modification*, 25 (3), 471-486.
- Petridou, E., Trichopoulos D., Stappa M., Tsoufis Y., Skalkidou A., & Hellenic Road Traffic Police Department. (1999). Effectiveness of a comprehensive multisector campaign to increase seat belt use in the greater Athens area, Greece. *American journal of public health*, 89 (12), 1861-1863.
- Poole, K., Kumpfer, K., & Pett, M. (2001). The impact of an incentive-based worksite health promotion program on modifiable health risk factors. *American journal of health promotion*, 16 (1), 21-26.
- Prochaska O. J., Norcross, J. C., & Diclemente, C. C. (1994). *Changing for good. A revolutionary six stage program for overcoming bad habits and moving your life positively forward*. New York: HarperCollins Publishers.
- Partnership for Road Safety. (2007). *Research on the attitude of active passengers and drivers to the use of seat belt*. Retrieved from <http://www.safedrive.ge>
- Thyer, B. A., & Geller, E. S. (1990). Behavior analysis in the promotion of safety belt use: a review. In M. Hersen, R. M. Eisler, P. Miller (Eds.) *Progress in behavior modification* (Issue 26, pp. 150-172). Newbury Park, CA: Sage.
- Ghazaryan, Petros (Host). (2009, August 25). Urvagitz [talk-show]. Yerevan: Kentron TV.
- World Health Organization. (2009). *Global status report on road safety. Time for action*. Geneva: WHO Press.

Yankelovich, D. (1994). How changes in the economy are reshaping American values. In H. J. Aaron, T. E. Mann, & T. Taylor (Eds.) *Values and public policy* (pp. 16-53). Washington D.C.: The Brookings Institution.

Endnotes

1. According to the data provided by the Road Police of Armenia, 407 people died and 3125 received injuries as a result of automobile accidents in Armenia during 2008. This means that mortality rate in the country per 100 000 population is 13.5, while according to the WHO's baseline data, mortality rate of the low-income European regions is 12.2 (World Health Organization, 2009, p. 13).
2. According to the information of the RA Road Police, the number of motor transport in Armenia is approximately 400 000.
3. I owe this joke to my colleague's father, Hamlet Karamyan.
4. According to the data provided by the Road Police of the Republic of Armenia, in 2008 the number of car accidents only in Yerevan comprised 41.7 percent of all car accidents in the country; the number of deaths from accidents in Yerevan comprised 21.3 percent and the number of injured persons 35.5 percent of the total number of deaths and injuries in Armenia.
5. During the Government meeting on 13 August, Prime Minister Tigran Sargsyan also spoke about the negative consequences of automobile accidents for the gross domestic product of the RA.
6. In his deconstruction of the concept of heterosexuality, cinema analyst Richard Dyer provides similar definition of masculinity and femininity: "Heterosexuality is posited on the gender difference femininity:masculinity. This is widely conceptualized in terms of opposites: male aggression, strength, hardness, roughness, and competitiveness as the opposite of female nurture, weakness, softness, smoothness and co-operativeness" (Dyer, 1997, p. 264).
7. An article on seat belts in a 2007 issue of one of the Armenian electronic periodicals told about a young Armenian lady, Siranush, who after having lived for two years in the United States started using seat belt in Armenia by the force of habit. "However, my friends and passers-by would laugh at me, and I

- stopped using it”, complained Siranush to the reporter (Drivers Do Not, 2007).
8. In one of the chapters of his book “Other Colors”, Orhan Pamuk provides insight into some specifics of the road traffic in Turkey in 1950-80s which is indicative of universality of negative perceptions about overly decent drivers. More specifically, the author writes that those drivers who were minutely observing all traffic rules in Turkey were thought of as being short of skills, keenness of wit, will, and imagination (Pamuk, 2008, pp. 264-269).
 9. According to my observations, the same phenomenon was taking place in the Republic of Kyrgyzstan in July 2009. I learnt that several months before my visit, a law had been adopted in the country requiring use of seat belt in urban areas and on highways outside of cities; however no serious awareness-raising initiatives had been taken before it. Very much like the behavior pattern in Yerevan, after the nightfall, the number of users of seat belt in capital Bishkek would drop significantly.
 10. During a talk show on one of the Armenian TV channels, a Road Police official mentioned that tinted cars had become a painful issue, and that the Police would take measures to punish those drivers the tint of whose cars exceeded the allowed percentage (Ghazaryan, 2009).
 11. This story was told by a respondent in the study on attitudes toward seat belts in Georgia (Partnership for Road Safety, 2007, pp. 14-15). I owe the information concerning Armenia again to Hamlet Karamyan according to whom stories about shirts with ribbons allegedly sewed in Armenia were circulating in Russia in the 1970s, at the time when the usage of seat belt became a legal requirement in the USSR once high-speed FIAT cars started to be produced in the country.

Public Health

ქართული ჯანდაცვის სისტემა და მისი დღევანდელი გავლენა ჯანმრთელობასა და კეთილდღეობაზე

ჩიხლაძე ნინო

*ივანე ჯავახიშვილის თბილისის სახელმწიფო უნივერსიტეტი,
ფირცხელაური ელენე,
ილიას უნივერსიტეტი,
ფირცხელაური ნატო
ივანე ჯავახიშვილის თბილისის სახელმწიფო უნივერსიტეტი,
სხვიტარიძე ნათია
საქართველოს უნივერსიტეტი*

წარმოდგენილ ნაშრომში ასახულია საქართველოს ჯანდაცვის სისტემის დღევანდელი გამოწვევები და მათი გავლენა მოსახლეობის ჯანმრთელობასა და კეთილდღეობაზე. შეფასება ჩატარებულია 2008-2010 წლის პერიოდში და ასახავს თუ რამდენად აკმაყოფილებს ქვეყნის დღევანდელი ჯანდაცვის სისტემა მოსახლეობის მოთხოვნას ხარისხიან ჯანმრთელობის სერვისებზე, რამდენად ეფექტურად განკარგავს არსებულ რესურსებს და რაოდენ წარმატებულია ჯანმრთელობის დაცვისა და სოციალური უზრუნველყოფის ინტერსექტორული თანამშრომლობა. ნაშრომში ასევე ხაზგასმულია პარალელები მოსახლეობის ჯანმრთელობის მდგომარეობას, სოციალურ კეთილდღეობას და ჯანდაცვას შორის.

Georgian Health System and its Recent Impact on Health and Social Well-being

*Chikhladze Nino,
Iv. Javakhishvili Tbilisi State University
Pitskhelauri Elene,
Ilia State University
Pitskhelauri Nato,
Iv. Javakhishvili Tbilisi State University
Skhvitaridze Natia
University of Georgia*

Health systems throughout the world are very different but in all countries they share the same goal or outcome as improving health. Health, as defined by WHO, is a state of complete physical, mental and social well-being and not merely the absence of disease or infirmity. Herewith social well-being is a good or satisfactory condition of existence, what means a state characterized by health, happiness, prosperity, welfare. Popular use of the term well-being usually relates to health. It's very difficult to reflect the health contributions by quantitative indicators in the social welfare, because the definition of health itself is very complex and at the same time due to the fact that the value categories of health could not be reflected like other services in the monetary category. However, there is evidence and it is undoubtedly that there are direct connections between health and social well-being (Figueras J., et al., 2008).

Health and wealth reinforce each other. Citizens draw satisfaction from living longer and healthier lives and value health regardless of whether or not they are economically productive. Wealth has a major effect on health in its own right, both collectively and individually. Its impacts are direct, through the material conditions that improve biological survival and health, as well as indirect, through its effects on social participation and people's control over their life circumstances.

Health care systems have a most important and effective impact not only on health, but also on wealth. Health systems are a catalyst for both. Better health improving economic performance and better economic performance improving health. However, Health Systems and social well-being (as good health and wealth) have a complex and dynamic relationship. This approach offers an opportunity for a fundamental reassessment of the role of health systems in society. Over the years, health care system's role contribution in the process of improvement of the public

health is changing. If just 50 years ago, scientists argued that health services made little meaningful contribution to population health, a few years ago medical services contribution was defined as 15% (Rechel, B., et al., 2009)

Since then the scope and quality of health care have changed almost beyond recognition, as it has defined more significant impact on health. Data on “avoidable mortality” or “mortality amenable to health care” can help to separate out the scale of the impact that health services alone have on health. This measure captures “unnecessary untimely deaths”, arising from conditions from which death should not occur in the presence of timely and effective health care. There are data’s of different states concerning some current researches about assessment of the effectiveness of health care systems. For example, statistical dates a study in USA show that about half of the total gain in life expectancy in the country could be attributed to curative services (Curry, N., Ham, C., 2010)

A study in New Zealand argued that 42% of the decline in deaths from ischemic heart disease could be attributed to advances in medical care . (Tollen,L., 2008).

A study in the Netherlands claimed that decline in mortality could be attributed to specific medical interventions. Overall, there is broad agreement that between 40% and 50% of the decline in ischemic heart disease may be attributable to improvements in health care. (Swayene, L.E., Duncan, W.J., Ginter, P.M., 2006)

Eliminating variation in the delivery of care services, according to evidence for best practices across health care systems, could save thousands of lives each year in Georgia.

To define health care exact quantitative contribution there are methodological difficulties, as these approaches have some limitations, but the approaches is extremely valuable as a tool for capturing how health system impact on health and social well-being.

According WHO approaches, a well functioning health system responds in a balanced way to a population’s needs and expectations by improving the health status of individuals, families and communities and

defending the population against what threatens its health

protecting people against the financial consequences of ill-health

providing equitable access to people-centred care

Making it possible for people to participate in decisions affecting their health and health system.

The structure of health system in Georgia

Health systems comprise all organizations, institutions, resources, people devoted to producing actions whose primary purpose are to pro-

mote, restore or maintain health. This definition incorporates “selected intersectoral actions in which the stewards of the health system take responsibility to advocate for improvements in areas outside their direct control, such as legislation to reduce fatalities from traffic accidents” (ChanturidzeT.,at al.,2009).

Most national health systems include public, private, traditional and informal sectors.

Ministry of Labour, Health and Social Affairs of Georgia implements state governance and state policy in the fields of labour, health and social affairs. The mission of the Ministry is to promote the population’s good health and functional capacity, promote healthy working and living environments, ensure that there are sufficient social and health services. Activities of the ministry include: to provide medical services and public health to the population; to regulate medical and pharmaceutical activity; to manage state pensions; to provide targeted social assistance to the population; to provide safe environment for living and working; to implement the function of guardianship and care, also the issues related to adoption and protection of rights and interests of child.

The structure of the Georgian health system also comprise Health and Social Projects’ Implementation Centre, Agency for State Regulation of Medical Activities , National Centre for Disease Control and Public Health, Social Service Agency, State Fund for the Protection and Assistance to Victims of Trafficking in Persons, State Care Agency, Health Insurance Mediation Service, Public and Private Hospitals, Public and private PHC providers, Public Health Services, Municipal health administration, Professional Associations, Nongovernmental organizations, Private Health Insurance Companies, Pharmacies, Parliament, Ministry of Economic Development, Ministry of Finance, Ministry of Education and Science, other Ministries, Medical Education Schools, Research centres.

The health system building blocks are defined by WHO. They are:

Health Service Delivery

Health workforce

Essential medical product, vaccines and technologies

Health systems financing

Health information systems

Leadership and governance

We will overview Georgian Health system’s two dimensions’: Health services Delivery system and Health workforce.

Health Service Delivery System in Georgia

Health services are the most visible functions of any health system. Every day health systems deliver services be they prevention, treatment

or rehabilitation that maintain or improve the health of individuals or their communities. In any health system good health services are those which deliver effective, safe, quality personal and non-personal health interventions to those that need them, when and where needed, with minimum waste of resources. Health services may be delivered in health facilities in the home or the workplace.

The system of services delivery in Georgia for public health services is represented by a central agency, the National Centre for Disease Control, which is subordinate to the ministry. Local bodies called Public Health Centres have been abolished in most of the local constituencies of the country. Past and present problems in health system performance, along with the deterioration in the social and environmental determinants of health, have had a long-lasting, negative effect on the health status of the Georgian population.

The Infrastructure of Georgian health Service delivery system included as in-patient as well out-patients health care facilities.

Polyclinics and ambulatories provide primary health care. The primary health care network includes polyclinics, ambulatories, nurse-midwife health posts and dispensaries-specialized outpatient clinics.

Polyclinics may be stand-alone facilities or associated with the outpatient departments of hospitals. People with specific diseases and population groups such as: children and women of reproductive age are "served" by dispensaries providing primary care services. Dispensaries are specialized in treating people with specific conditions, such as tuberculosis, drug addiction, etc. Specialized care is provided in municipal hospitals, specialized hospitals, research institutes and dispensaries. Municipal hospitals provide inpatient and outpatient care and the most basic specialist services, including emergency services. Research institutions provide more complex mostly diagnostic services, such as radiology.

The private sector is strongly involved in providing services. There are several registered private pharmacies and pharmacies. Nearly all dentistry practices are private.

In 2008 the total number of health care facilities were 1876 (independent 1020 and dependent, functioning together with other health providers-856) (NCDC, 2008)

The structure and distribution of independent health care network was: in-patient facilities-25,9%, dispensaries-6,8%, polyclinics-16,8%, dental polyclinics-6,8%, women's consultancies-1,9%, ambulance stations (providing emergency care by phone call, the service is chargeable)-6,8%, doctor (in rural ambulatories)-21,5%, blood transfusion stations-0,58%, infant nurseries-0,19%, scientific research institutes-1,6%, health centres-4,0%. The structure and distribution of dependent health care network was: rural doctor ambulatories-55,4%, nurse-midwife health posts-

35,1%, co-social with hospitals- 8,4%, doctor health posts-1,1%. (see table №1)

Table №1 *Health Care Network structure, Georgia, 2005 and 2008*
(NCDC, 2005,2008)

Type of Health facilities	2005	Type of Health facilities	2008
In-patients facilities	269	In-patients facilities	269
Dispensaries	77	Dispensaries	72
Independent:		Independent:	
Policlinics	180	Policlinics	171
Dentist Clinics	100	Dentist Clinics	79
Ambulance stations	72	Ambulance stations	73
Rural ambulatories	312	Rural ambulatories	220
Nurse-midwifery posts	1	Nurse-midwifery posts	X
Blood transfusion stations	2	Blood transfusion stations	6
Scientific-Research Institutions	20	Scientific-Research Institutions	19
Medical Centres	51	Medical Centres	47
Dependent:		Dependent:	
Medical doctor's Posts	11	Medical doctor's Posts	9
Rural doctor ambulatories	373	Rural doctor ambulatories	474
Nurse-midwifery posts	385	Nurse-midwifery posts	301

Primary care is characterized over-capacity. In 2008 616 independent and 72 working within hospitals out-patients facilities have reported to the National Centre for Diseases Control and Medical Statistics. These

out-patients facilities are represented by 241 independent polyclinics, 47 medical centers, 79 independent dental clinics, 20 women consultative, 72 dispensaries, 220 independent ambulatories. There are 474 dependent ambulatories and 301 dependent nurse-midwife posts in the structure of ambulatory-polyclinic associations.

All out-patient facilities working registered 1809208 cases of diseases which is more than in 2005. There were registered 807497 new cases of diseases; this indicator is 13, 5% more than in 2005.

In 2008 general an incidence and prevalence increased both in total population and children. In 2008 the average number of visits to the primary health care facilities was per person per year 2, 1. In 2008 the out-patient facilities the total number of visits per person per physician per year was 724, 5, which is less than in 2005. The average number of ambulatory visits per capita is still markedly below the rates of almost all other European countries.

In 2008 there were registered 651381 routine inspections of children and adolescents. During preventive inspection cases of low hearing (0, 12%), low vision (0, 53%), speech disturbance (0, 41%), scoliosis (0, 61%) and disorders of bearing (0, 47%) were revealed. 27426 surgical operations were conducted at the surgical department of the out-patients facilities. This is more than in 2004. In 2008 there were 22 day time hospitals with 408 beds, where 20534 patients were treated, including 11727 children.

The level of the usage of the capacity of the out-patient network is only 38,3%. It is to be mentioned that in 1988 the out-patient network was loaded by 84, 7% and in 2001- 26,3%.

In 2008 in-patient health care facilities provided totally 14069 hospital beds (320.9 hospital beds for every 100 000 population).

In 2008 in the comparison with 1991 the total number hospital beds was reduced by 73, 5 %. Nevertheless, the total number of hospital and hospital beds in Georgia the supply is still much greater than in the WHO European Region (NCDC, 2008)

Despite these reductions, the numbers of hospital beds remain high compared to European countries, approximately twice. As a rule hospital beds are used to indicate the availability of inpatient services. It's clear that in the case of Georgia Health care facilities are very largely.

Statistical data's reflect that despite the abundance, there is inequality in distribution of the medical institutions by the regions. (see Table №2)

Table №2 *Health Care facilities distribution by region, Georgia, 2008*
(NCDC, 2008)

Region	Policlinics	Dispensaries	Medical Centres	Independent ambulatories	Hospitals
Tbilisi	84	11	24	4	77
Ajara	16	8	3	0	17
Guria	7	6	2	2	6
Racha-Lechkumi and Kvemo Svaneti	3	0	0	12	4
Samegrelo	18	6	3	2	25
Imereti	36	14	4	105	25
Kakheti	21	7	3	10	35
Mtskheta-Mtianeti	3	0	0	30	25
Samtkhe-Javakheti	16	56	0	11	5
Kvemo Kartli	13	6	2	21	12
Shida Kartli	12	7	0	21	11

During last years the total number of hospitalizations was increased. In 2008 the level of hospitalizations per 100000 was 7204, 5. In 2008 in comparison with 2005, the level of hospitalizations was increased by 17, 1%. At the same time, total number of bed-days by patients in hospitals was increased by 158830 bed-days and equalled to 2183714 bed-days.

In 2008 a hospital bed occupancy rate was 156,1 days, with average length of stay of 6,8 days, which is lower than in 2005 (7 days) and in 2004 (8,7 days). Reduction in the average length of stay means that more hospitalizations can be achieved without significantly increasing resources (NCDC, 2008).

The highest bed occupancy rate and average length of stay in Georgia in 2008 were registered for patients with tuberculosis, ontological and mental health problems. (See Table №3)

Table №3 *Hospital beds by profiles and their utilization, Georgia, 2008* (NCDC, 2008)

Profiles	Number of beds	Occupancy Rate (days)	Average length of stay	Bed rotation
General Medicine	2007	130.4	5.1	26.5
Paediatric	1438	181.7	6.9	26.8
Surgery	3453	125.1	5.5	23.1
Oncology and Radiology	403	278.4	15.4	18.1
Infectious Diseases	878	108.4	6.2	17.7
TB	580	253.0	42.3	5.2
Obstetric-Gynaecology	2775	128.7	4.3	30.0
Neurology	319	180.1	8.3	22.2
Psychiatry and narcology	1341	261.7	74.0	3.6
Otolaryngology	184	52.1	1.5	36.0
Ophthalmology	184	79.2	3.0	26.2

The average length of hospital stay has decreased over the past few years, but is still much higher than in the WHO European Region. The bed rotation rate was increased from 15, 2 (in 2005) to 22, 9 in 2008.

In 2007 Georgia had one of the lowest acute care hospital admission rates in the WHO European Region, at just 6.3 per 100 population, when the average for the EU was 17 per 100 (2006). The average length of stay in acute care hospitals in Georgia was 5.7 days in 2007, which is below the 2006 EU average of 6.5 days.

Following independence, there has also been a sharp decline in the hospital bed occupancy rate, largely linked to a lack of affordability combined with excess capacity in the hospital sector. The acute care hospital bed occupancy rate is now among the lowest in the WHO European region, at just 34.4% in 2007. The average for countries of the EU was 76.3% in 2006. The average length of stay has been falling since 2003, and was 5.7 days in 2007 in acute care hospitals.

By the end of 2008 315829 patients were discharged from hospitals in Georgia, including 6140 patients died. The total case fatality rate equals to 1, 9, like in 2005. In 2008 121189 operations were performed in hospitals, 55,9 % of surgical operations were made under general narcosis. 19% of the operations were urgent. The total post operational case fatality rate is 0, 5%.

The reported occupancy rate of 40%, however, still represents very low utilization of existing inpatient facilities.

The excess capacity in the health system is a remnant of the early Soviet Union model based on normative planning which at one point in the early 1980's required Georgia to have 60,000 hospital beds to serve its population. Although there have been significant reductions in health service delivery capacity over the past 10 years, existing hospital bed capacity is still more than in WHO European countries. There are a problems of over-capacity of hospitals, their equipping and they are costly to maintain, that's why

The Hospital Development Master Plan "100 New Hospitals for Georgia" was developed and enforced by the government from January 2007.

Efficient allocation of resources is an important aspect of effective performance and supports improvements in health system productivity and accessibility.

Health workforce in Georgia

Effective health service delivery depends on having some key resources among them require a skilled well performing and motivated workforce. Health workers, as defined WHO in World Health Report, are "all people engaged in actions whose primary intent is to enhance health" and to protect and improve the health of their communities (WHO, 2000).

In any health system a "well-performing" health workforce is one which is available, fairly distributed, competent, responsive and productive. And whose actions are adequately to the needs and expectations of people.

Georgia traditionally has the highest density of health workers, particularly physicians. However, although there are a large number of

trained doctors in the country, they are very unevenly distributed. There is a concentration of doctors in capital city where there are approximately three times as many doctors as there are in other regions. Among Georgian regions the lowest indicators are in Samtkhe-Javakheti (203,0) and Qvemo Qartli (232, 8).

Utilization of physicians for both inpatient and ambulatory care services is very low. On an annual basis, there are approximately 29 patients per full-time hospital physician; but this ratio varies significantly across regions. Although this is an improvement from 25 patients per physician in 2004, physician productivity is still the lowest among WHO European countries.

The low productivity of physicians raises concerns regarding quality of services, salary levels and low levels of motivation in the health care workforce.

In Georgia, the number of nurses is the lowest in Europe. The number of middle medical staff has decreased dramatically since independence; in 2008 the number of nurses per 100000 population was 19593. Its comparison with WHO recommendation on the balance between the number of doctors and nurses (1:4) in Georgia. In the recent years, this ratio is practically 1:1.

It is known that nursing services play a vital role in improving health service delivery and achieving national health goals and the health-related Millennium Development Goals.

Nurses represent the basic unit of the Health care. Population Health is depends on their knowledge and skills and professional relation with the patient.

We think that Georgia should pay attention not only to the improvement of balance indicators of doctors and nurses, but also to the improvement nursing education. The International Council of Nurses recommends that system of nursing education should ensure that study are regularly updated to satisfy the needs of a changing environment and that they are probably applied and address the need for lifelong learning, in accordance with the specific historical context of each country. For its part, the WHO recommends, for development of science and education in nursing, that particular attention be paid both to the macro determinants and to the needs and demands of health and the services the serve.

Health needs of society, public interests and social expectation, labor market, global trends on nursing field, the recommendation of WHO European strategy for nurses' and midwives' education, Bologna process, Tuning Methodology – these are the factors proving the necessity of the reform in the educational system for nurses in Georgia.

The existing system of nursing education in Georgia does not satisfy nurse activity requirements as an independent profession and scientific discipline.

Access to quality medical services is one of the main prerequisites for improving the health and well-being of the population. Resources should be well-trained and sufficient. In order to improve this goals the government should assure the equal distribution of medical staff, implementation of system of continuous professional education for health workers and Higher Education for nurses. Program of transformation of nurses' and midwives' education is a complex strategy of government's actions in order to provide adequate number of well-skilled nurses prepared for professional activity for the improvement quality of health services and benefit of health of our country's citizens.

The contribution of the health system to Georgian population health

The key indicators of life expectancy and mortality are used to assess overall health status and to measure progress in a number of targeted areas, such as reducing the incidence of major causes of mortality and morbidity and reducing rates of infant, child and maternal mortality. There has been substantial improvement on a number of these indicators since the mid-1990s.

Life expectancy at birth has increased for both men and women, and rates of infant and maternal mortality have decreased. According to the official statistical data provided by the Department of Statistics in 2008 life expectancy at birth in Georgia was equalled 74.2; for men- 69.3 and for women- 79,0. So, in 2007 a sex difference for average life expectancy was 9, 7 years, while in 2002 the index was 7, 7 years.

Table №4 *Life expectancy at birth, Georgia, 1990 – 2008 (NCDC, 2008)*

	1990	1995	2000	2001	2002	2003	2004	2005	2006	2007	2008
Total	71,4	70,3	71,3	71,6	71,5	72,1	71,6	74,0	74,3	75,1	74,2
Male	67,5	66,3	67,5	68,1	68,0	68,7	67,9	70,0	69,8	70,5	69,3
Female	75,0	74,2	75,0	74,9	74,9	75,3	75,1	77,6	78,6	79,4	79,0

An increase in aged population (75-85) of the elderly population is connected with the increase of average life expectancy; however, they (60-75) constitute the largest age group. In the structure of 60-years-old and over age group, alongside with the age interval increase, the share of the mentioned group decreases. For example, in the structure of 60-years-old and over, the highest share has population of 60-64 years age groups (5,9%), the lower – the population of 100-years age group and over (0,01%).

In Georgia life expectancy in 2005 was three years higher than in Armenia and six years higher than in Azerbaijan, which suggests that the health status of the population is generally better. While there have been improvements, life expectancy are still lower in comparison with life expectancy in other countries of Europe.

According to the World Health Organization data (WHO, 2002), expected healthy life expectancy for the Georgian population is 58, 2 years, which is 13, 3 years less than the expected average life expectancy. For women this index is 60,2 years, this is 14,6 years less than expected average life expectancy in women, for men the index is 56,1 years, this is accordingly 11,9 years less than the expected average life expectancy in men. Sex difference in healthy expected life expectancy was 4, 1 year.

In 1989-2000 share of those aged 60 years and over in the whole population increased from 14, 3% to 18,6%. During the period of 2002-2008, the number of children under 15 years of age reduced to 3.4 percent, whereas the population over 65 years old rose to 1.6 percent. By 2030, an estimated 21% of Georgia's population will be 65 years old and older. (WHO, 2006; OSGF, 2007)

As the length of life increases, older people can respond with lifestyle changes that can increase healthy years of life. Correspondingly, health care systems need to shift towards more geriatric care, the prevention and management of chronic diseases and more formal long-term care. Since people are living longer, measures to improve health and prevent disease need to focus on people of working age.

In Georgia the mortality rate reached a maximum in 2004 and was equalled 11.3. In 2008, 43011 cases of death had recorded. 63.5% of all death cases had accounted in urban areas and 36.5% - in rural areas. Mortality rate in males is greater than in females: 11.2 and 8.5 accordingly. In the structure of cause of death very high share have disease of the circulatory system and neoplasm. In 2008, the mortality structure, according to the ICD-10 classification, had distributed in the following way: diseases of the circulatory system accounted for 64.1 percent; neoplasms - for 10.8%. The third place occupies a class 'Symptoms, signs and abnormal clinical and laboratory findings' (8.5%), which is not used for mortality coding (according to the WHO criteria).

An increase in aged population (75-85) of the elderly population is connected with the increase of average life expectancy; however, they (60-75) constitute the largest age group. In the structure of 60-years-old and over age group, alongside with the age interval increase, the share of the mentioned group decreases. For example, in the structure of 60-years-old and over, the highest share has population of 60-64 years age groups (5,9%), the lower – the population of 100-years age group and over (0,01%).

In Georgia life expectancy in 2005 was three years higher than in Armenia and six years higher than in Azerbaijan, which suggests that the health status of the population is generally better. While there have been improvements, life expectancy are still lower in comparison with life expectancy in other countries of Europe.

According to the World Health Organization data (WHO, 2002), expected healthy life expectancy for the Georgian population is 58, 2 years, which is 13, 3 years less than the expected average life expectancy. For women this index is 60,2 years, this is 14,6 years less than expected average life expectancy in women, for men the index is 56,1 years, this is accordingly 11,9 years less than the expected average life expectancy in men. Sex difference in healthy expected life expectancy was 4, 1 year.

In 1989-2000 share of those aged 60 years and over in the whole population increased from 14, 3% to 18,6%. During the period of 2002-2008, the number of children under 15 years of age reduced to 3.4 percent, whereas the population over 65 years old rose to 1.6 percent. By 2030, an estimated 21% of Georgia's population will be 65 years old and older. (WHO, 2006; OSGF, 2007)

As the length of life increases, older people can respond with lifestyle changes that can increase healthy years of life. Correspondingly, health care systems need to shift towards more geriatric care, the prevention and management of chronic diseases and more formal long-term care. Since people are living longer, measures to improve health and prevent disease need to focus on people of working age.

In Georgia the mortality rate reached a maximum in 2004 and was equalled 11.3. In 2008, 43011 cases of death had recorded. 63.5% of all death cases had accounted in urban areas and 36.5% - in rural areas. Mortality rate in males is greater than in females: 11.2 and 8.5 accordingly. In the structure of cause of death very high share have disease of the circulatory system and neoplasm. In 2008, the mortality structure, according to the ICD-10 classification, had distributed in the following way: diseases of the circulatory system accounted for 64.1 percent; neoplasms - for 10.8%. The third place occupies a class 'Symptoms, signs and abnormal clinical and laboratory findings' (8.5%), which is not used for mortality coding (according to the WHO criteria).

improvements in the population's health status but also demonstrate the challenges facing the Georgian health care system. Unemployment and poverty cause many problems to the society and its well-being.

One of the key strategies for improving in next decade Georgian population health and social well-being is to strength of the health system, to increase the productivity of health care providers and facilities, to improve the effectiveness and the quality of medical care services. In addition, addressing major health challenges and working to improve health status and well-being of all Georgian is not as exclusive responsibility of the MoLHSA, but rather is the task of the entire government.

References

- Chanturidze, T., et al. (2009). Georgia health system review. *Health Systems in Transition, European Observatory on Health Systems and policies*, vol.11, #8. 23-31
- Curry, N., & Ham, C. (2010). *Clinical and service integration; the route to improved outcomes*. King's fund.
- Figueras J., et al. (2008). Health systems, health and wealth: Assessing the case for investing in health systems
http://www.osgf.ge/data/file_db/Publications/jandacva2_7gB9Sn07WM.pdf
- National Centre for Disease Control - Statistical Yearbook. (2005). Health and Health Care in Georgia
- National Centre for Disease Control - Statistical Yearbook. (2008). Health and Health Care in Georgia.
- Open Society Georgia. (2007). The Georgian Health Care System
- Rechel, B., et al. (2009). *Capital investment for health*. http://www.euro.who.int/InformationSources/Publications/Catalogue/20090908_1
- Swayne, L. E., Duncan, W.J., & Ginter, P.M. (2006). *Strategical development of health care organizations*, 24–310.
- Tollen, L. (2008). *Physician organization in relation to quality and efficiency of care: a synthesis of recent literature*.
www.commonwealthfund.org/usr_doc/Tollen_physician_org_quality_efficiency_1121.
- WHO (2000). Health Systems: Improvement of actions (WHO Report)
- WHO (2009). Health system performance assessment - Georgia
- WHO. (2005; 2006) Highlights on health in Georgia

პაციენტის და ოჯახის წევრების ჩართულობა საკუისრო კვეტის გადაწყვეტილების მიღებასთან დაკავშირებით

ჭეიშვილი ჯილდა

*პარტნიორების საერთაშორისო განვითარებისათვის,
ემორის უნივერსიტეტის წარმომადგენლობა საქართველოში*

ამ თემაში საუბარია, რომ საკუისრო კვეტის რიცხვის რაოდენობამ იმატა, განსაკუთრებით ხშირია კვეტა დედის “დაჟინებული” მოთხოვნით. მოცემული პრობლემის გამოსაკვლევად მიზნად დავისახეთ კვლევის ჩატარება, რომელსაც უნდა ეპასუხა მთავარ კითხვაზე – საკუისრო კვეტის გადაწყვეტილების მიღების მომენტში პაციენტისა და მისი ოჯახის წევრები ფლობდნენ თუ არა სწორ და სათანადო ინფორმაციას. კვლევა ჩატარდა იმერეთის რეგიონში, ქუთაისის დედათა და ბავშვთა სამხარეო დიაგნოსტიკურ ცენტრში. 2010 წლის მონაცემების საფუძველზე საკუისრო კვეტა გაკეთდა 792 შემთხვევაში, რანდომიზაციის წესით ამორჩეულ იქნა რესპოდენტები განხილული იქნა ისტორიების მონაცემები და გაკეთდა მათი ანალიზი, დედებმა უპასუხეს სპეციალურად შემდგარ კითხვარს. კვლევის საფუძველზე შეგვიძლია ვიმსჯელოთ, რომ საკუისრო კვეტით მშობიარობა პირდაპირკორელაციურ კავშირშია ნაყოფის/ახალშობილის და დედის (ადრეული, მოგვიანებითი) შემდგომ გართულებებთან.

კვლევის შედეგად ნათელი გახდა, რომ მთავარ პრობლემას წარმოადგენს დედისთვის ინფორმაციის დეფიციტი და მშობიარობის მართვის არცოდნა. პრობლემის აღმოფხვრისათვის აუცილებელია არამარტო დედის არამედ ზოგადად საზოგადოების ინფორმატიულობა ბუნებრივი მშობიარობის უპირატესობის შესახებ. ამისათვის საჭიროა ყველა საინფორმაციო საშუალების გამოყენება.

Engagement of Patient and Her Family Members into Cesarean Section Decision

Cheishvili Jilda

*Partners for International Development
Atlanta University*

Cesarean section is one of the most commonly performed surgical operations in the world today. However, in a growing number of cases worldwide, caesarean section is being performed without any medical need. In the last decade, increasing numbers of cesarean section were observed in the most developed countries of the world. In Georgia, 17,722 cesarean sections were performed, representing 28,7 % of total deliveries in 2009 (for comparison, in 2007, it was 22,2% and in 2008, it was 24,7%). (Figure 1).

The rising number of such deliveries suggests that both health-care workers and their clients perceive the operation to be free from serious risk. Many epidemiological studies have attempted to evaluate the risks (and benefits) associated with caesarean section performed without medical indication, but a clear causal relationship between the surgery and maternal complications has been elusive.

Based on the study, we are able to conclude, that the number of Cesarean section is increased, and main contributing factor for that being the mother's request.

We were interested, what was the reason, that the mother and other family members decided to have a C-section.

Based on the conducted study, it was determined that the mother receives the information, but it is not necessary. A lack of personnel to oversee the delivery process conditions that mothers use to make wrong decisions (Cesarean section for pain relief).

Materials and Methods

According to the available data, the population of Georgia as of 1 January 2010 was 4,436,400 (National Center for Disease Control and Public Health).

In January 2011, the population of Georgia was 4,469,200. Compared to the previous year, the population increased by 0.7% (data from Abkhazia and Tskhinvali region are not included). 52.4% of population are women, and 47.6% are men.

In 2000-2007, the birth rate did not change significantly. Every year the number of newborns fluctuated in the range of 47,000 and 49,000.

In 2008, the number of births increased to 56,656, and in 2009 it reached 63,377. In 2010, it decreased to 62,585. (Figure 2)

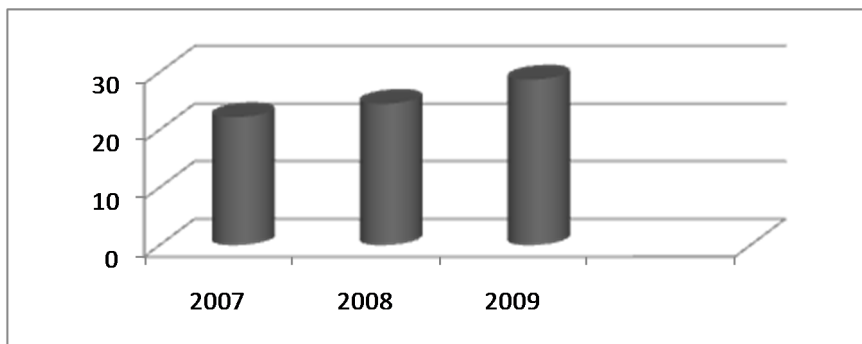

Figure 1.

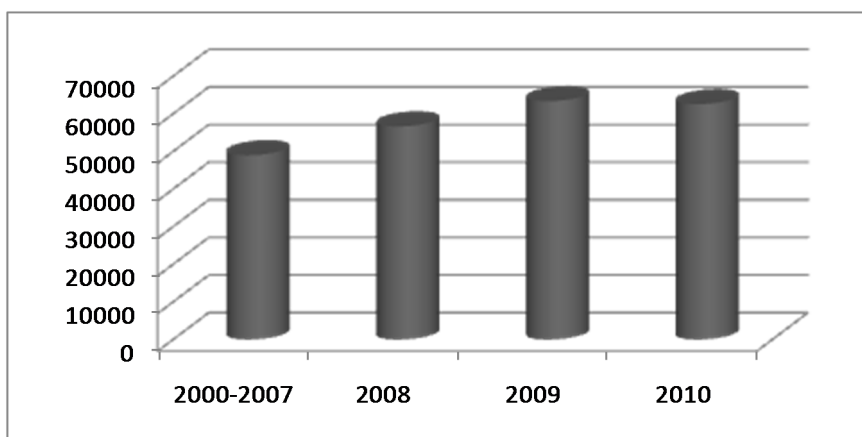
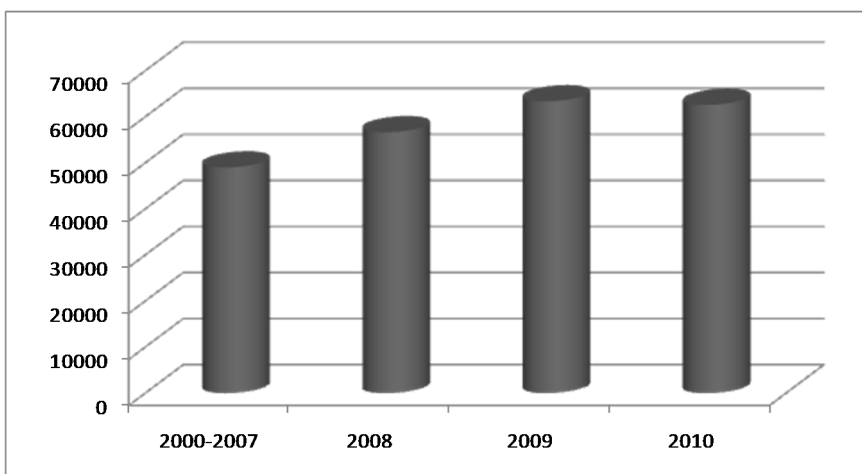

Figure 2.

A children's generation in Georgia makes up only 70-80% of their parent's generation (in absolute numbers). According to same data, there are only 14 countries with similarly low indicators. The increase of the use of C-section can cause a decrease in the birth date.

In the last decade, an increase in the number of Cesarean sections performed was observed in the most developed countries of the world.

In Georgia, the Primary C-sections were accounted for 67,9 % of the total number of performed Cesarean sections; 57,9% from them represented urgent cases. Obstetrical forceps's were used in 81 cases; vacuum extraction was used in 149 cases. The share of trauma complicated delivery cases to total number of deliveries was 4,7%.

The number of Cesarean sections especially increased in the private maternity hospitals (in some cases to 40-80 %). (Ncdc.ge.)

Despite the World Health Organization (WHO) recommendation, which states that Cesarean sections in a country should not exceed 15 %, in Georgia the number of C-sections reached 30%, according to the latest statistical data. (Ncdc.ge.)

If years ago the C-section surgery was conducted only if there were medical indications, during the past 5-6 years this operation has been performed more frequently solely because it is requested by women in labor. Although C-section is included in the list of high risk surgery operations not only in the Georgia, but also in other European countries, it becomes more and more popular. The alternative of "suffering" labor, which could have further complications and even fatal cases. Today the patient has the right to choose C-section, in this cases surgery is performed according the patient's request.

Cesarean Delivery on Maternal Request (CDMR) has become a very important issue for many countries. Based on the available information, an increasing number of Cesarean sections are performed precisely because of the mother's request (while the doctor has to act in compliance with the patient's rights).

We became interested in the reason for that fact, and conducted a study, which examine how women in labor and their relatives are informed about Caesarian section, what positive and negative sides it has, which complications might developed for the mother and the fetus, how much are they aware about the advantages of natural delivery, what was the reason family members decided to make C-section, what was the main reason which led to the decision.

The study was conducted in the Imereti region, where percentage of C-sections is the highest (39,5%).

Facilities chosen had to met two main criteria: The availability of effective prenatal patient care practice since 2005 and a large annual number of deliveries (approximately 1,500 delivery per year).

Based on these criteria, in the Imereti region the pilot facility of women healthcare program was chosen: The Mothers and Children Regional Diagnostic Center, where principles of effective perinatal care were first established.

This maternity facility covers the city of Kutaisi and its suburban geographic areas. Every year this facility receives about 1,500 women in labor. Facility's specializations include term pregnancies, deliveries at labor, it also manages also premature labor.

In the 2010, 2,016 women in labor were admitted to the above-mentioned facility. 1,189 children were born through physiological delivery, in 792 cases Cesarean sections were performed, and stillbirth was observed in 35 cases (figure 3).

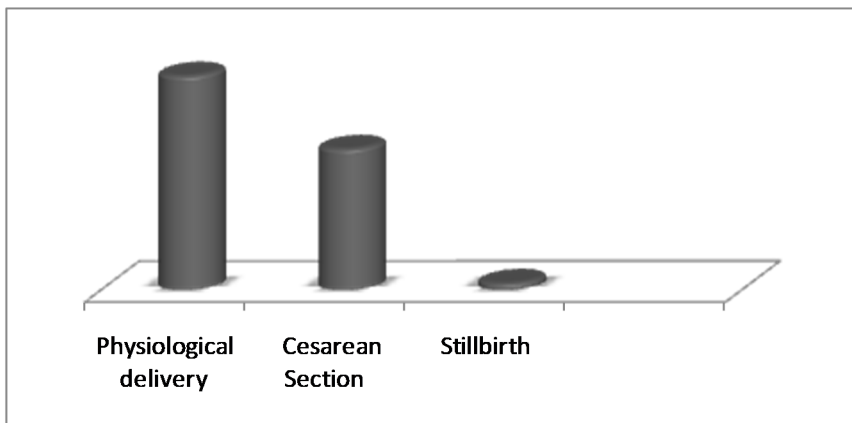

Figure 3.

As we discovered by interviewing the doctors, the indicator of Caesarian section is quite high (39%) and very often Cesarean sections are performed at the patient's request (non-medical indication).

Selected patients were Georgians by nationality. Age was in range from 14 to 45, most of them were 20-24 years old women.

Most of the patients were urban residents, and more than half of them had higher education.

More than half of the patients were in a registered marriage.

Mothers filled in a specially designed questionnaire, based on which we are able to make some conclusions.

Most of the patients visited gynecologist at the outpatient's clinic in the first or second month of pregnancy (the first trimester).

65% of the patients attended antenatal educational courses; 35 % percent stated that they had been advised to attend these courses by their doctor, but because of a lack of time (work, family problems, etc), they

were not able to attend them. Only 3 mothers mentioned that they had never heard about those courses.

It should be noted that these courses were attended only by mothers, no cases of fathers' attendance were registered, although all patients were advised by doctors to attend this course with a partner (spouse, mother, friends and etc)

In 100% of the cases, the pregnant women were provided by doctors with recommendations regarding healthy food, lactation, life style changing, and proper management of pregnancy.

Delivered information was clear to 85% of patients, although 10% stated that the medical personnel used terminology that was unclear or they could not understand.

85% of pregnant women mentioned that the antenatal period of pregnancy was going physiologically, and 15% indicated that they had a pathological pregnancy.

The C-section surgery decision was made by the doctor in 30% of the cases; in 60% of cases, this decision was made by the mother; and in 10 % of the cases, the decision was made by a family member (in three cases, it was made by mother of the woman in labor when the woman was 17 years old; in 5 cases it was made by the mother of the woman in labor because she had painful labor herself and did not want to her daughter to "suffer;" in the remaining two cases, the decision was made by the husband).

The "driving force" for these decisions was a fear of labor pain, 37% of the mothers said that they were very emotional and would not be able to endure pain, 28 % of the mothers had already undergone Cesarean section (2 and more years go). The patients' histories were reviewed and it was found out that 63% of the mothers were unipara and 36% were pluripara (Figure 4).

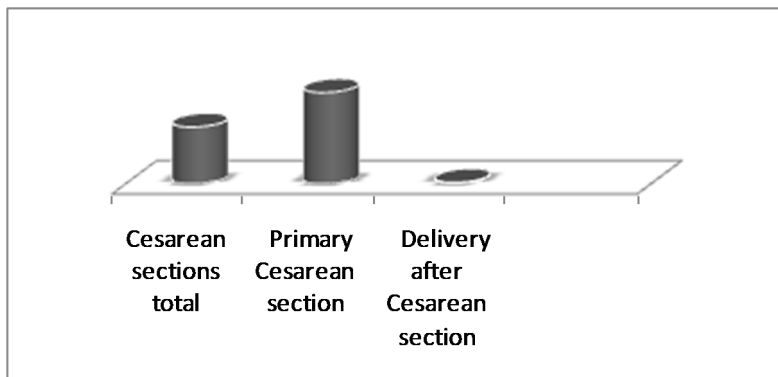
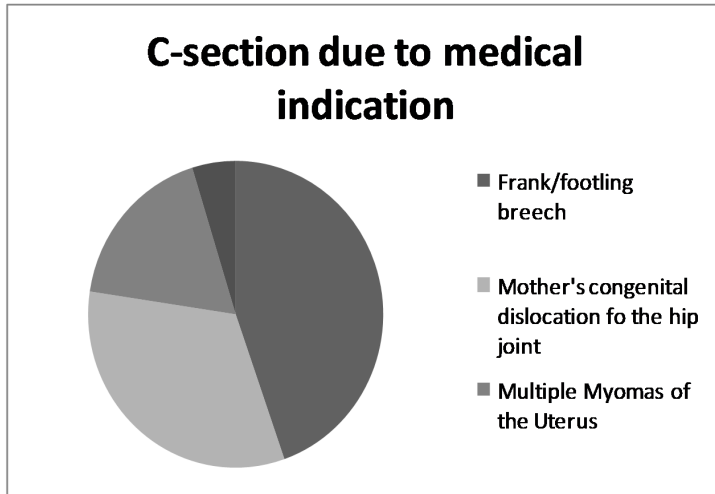
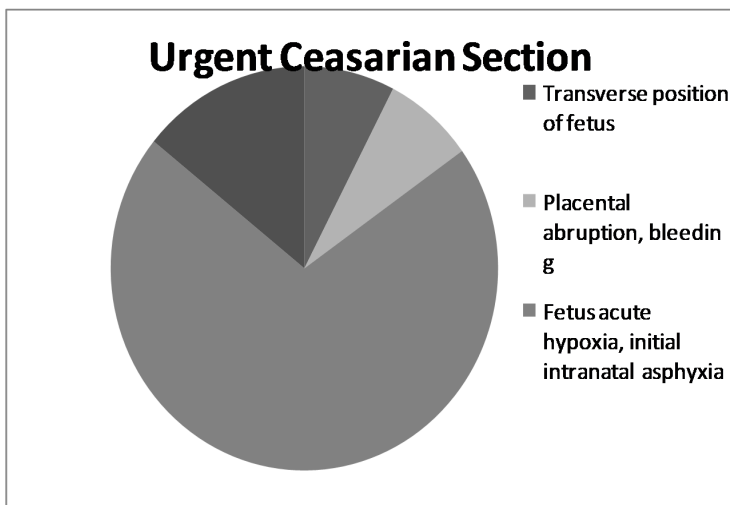

Figure 4.

Cesarean section due to a medical indication was performed in 35% of cases (frank/footling breech in 15% of the cases, mother's congenital dislocation of the hip joint in 11%, multiple myomas of the uterus in 6%, and preeclampsia in 1.6%).



Emergency C-section was performed in 21% of cases (transverse position of the fetus in 1.6%, placental abruption, bleeding in 1.6%, fetus acute hypoxia, initial intranatal asphyxia in 15%, premature rupture of membranes, arrested labor in 3% of the cases).



Review of the mother's histories revealed that they had multiple medical problems: preeclampsia, most of the pregnant women were complaining of increased tonus of uterus (expected abortion, expected premature labor, chronic hypoxia of the fetus). Cases of anemia were also present (mild and severe forms).

Four cases of previous obstetrical problems were indicated in medical history (stillbirth, spontaneous abortion).

Cesarean delivery on maternal request (no medical indications, the patient's request) was performed in 44% of the cases.

Four mothers noted, that they were not informed about that. In 17 % of cases, it was impossible because of newborns health conditions (resuscitation measures were required). Sixty percent of the mothers announced, that fathers refused to put baby on the belly.

In most cases, first breast catching was performed after two hours of delivery. Only 8 cases of late breast feeding were observed, when baby was brought on the second day (due to mother/child pathology)

Most of the mothers said that they had problems with baby feeding; in 80% of the cases, natural breast-feeding was completely substituted with artificial meal in one or two months after the childbirth. Only 10% of the mothers were exclusively breast-feeding during the first 6 months, and the remaining 10 % were taking breast milk even now (1.5 year old children).

The Mothers had complaints regarding baby's sleep in 30 % of cases; neurologist was needed for 60% of the newborns, usually at the age of 5 or 6 months. Symptoms included tremors, capricious behavior, etc.

In 85% of Cesarean sections, the mothers wanted to deliver their second baby using the same method; in 15% of the cases, they wanted to deliver by natural delivery (because of complicated post-operational period).

Results

Based on this study we can suppose that in the hospital under study, the percentage of Cesarean section performed at the patient's request (with no medical indications) is quite high.

The facts that fathers (including child's fathers) tried to avoid attending the antenatal educational course and that upon delivery only 16% of the newborns were put on the father's bellies demonstrate that our society does not correctly perceive the necessity of these and not only the father, but the society is not appropriately aware about the importance of its engagement in the pregnancy and labor periods.

Although all mothers emphasized that the doctor clearly explained that they were able to deliver physiologically, the information provided

was verbal, not written, and it was mentioned that they would like to receive additional information during the doctor visits.

Only one case of physiological delivery after Cesarean section was observed.

Early beginning of breast-feeding (first breast catching) is very important for the baby's health. According to the CDC data based on meta-analysis, women after Cesarean Section (planned, urgent) more often feed child with artificial food, rather than mothers after physiological delivery. Social and medical factors are also very important (early breast catching and newborn isolation). They reduce chances for proper management of natural, long-term breast-feeding.

Based on interviews with the mothers, we discovered that they are very well-informed about advantages of breast-feeding, what skin to skin contact means, the right positioning of the baby during the feeding, and correct breast-feeding. They have this information, but in the first and second day after the surgery, they feel fatigue. These are exactly the days, when the mother actively has to be involved in the breast-feeding process, but the lack of her engagement very soon (1-2 months) leads to the substitution of natural feeding with the artificial one.

It should be mentioned that most of the interviewed mothers are pregnant now and decided to deliver baby using Cesarean section.

Based on this study we can suppose, that Cesarean section delivery is in direct correlation with fetus/newborn later complications. (Figure 5)

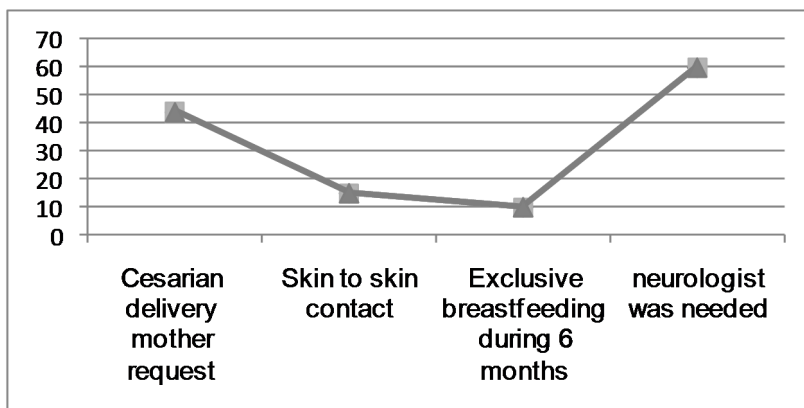

Figure 5.

The outcome is very clear, as more Cesarean sections are performed, more medical interventions are needed with newborns.

All mothers mentioned that the doctor (outpatient's clinic or obstetrician-gynecologist) explained the advantage of physiological delivery, but no one new, why it was better, how Cesarean section can affect the

mother and the child, what complications may ensue for the mother and the newborn. Mother was not prepared psychologically for the labor.

We interviewed a doctor from outpatient's clinic and found out that in this clinic they have a fully functional parents' school, all doctors advise mothers to attend the antenatal educational course, they have possibility to receive comprehensive information about pregnancy, advantages of breast-feeding, the importance and necessity of skin to skin contact in the language understandable to them.

The Center is equipped with modern video and audio equipment. As it was discovered, after a consultation with the doctor, most mothers are interested in attending these courses. Mothers come to lectures alone (without a partner). If we consider that most of unipara mothers are 18-24 years old, they are interested also in community's (not only doctor's) opinion about delivery (which is more "easy" –physiological delivery or C-section?)

As it is shown in this study, the number of CDMRs is higher in Georgia than in other countries (in the USA and Brazil, it is 18%, in Italy the number stands at 9%, in Sweden at 15,8%, and in Norway it stands at 7,6%.) (Figure 6).

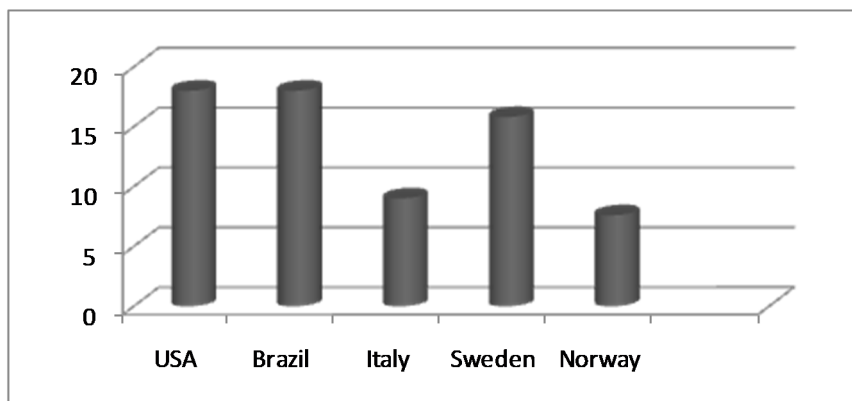

Figure 6.

The National Institute of Child Health and Human Development (NICHD), the National Institutes of Health (NIH), the Office of Medical Application of Research (OMAR) are all currently working on this issue.

The FIGO (International Federation of Gynecology and Obstetrics) supports physiological labor and argues that in such cases (non-medically necessary C-section) we not so much defend the patient's rights as violate the Ethical Code. They recommend that surgical intervention without indication is not a high quality medical service. Cesarean section should be

performed only if there are (medical) indications, to provide of the mother's and child's wellness and improve the outcome.

According to the ACOG (American College of Obstetrical and Gynecologist) Ethical Committee, the doctor violates the Ethical Code if he or she provides the mother with information leading her to believe that Cesarean section will provide her and baby's wellbeing.

According to the Georgian legislation and medical law, in the case of absence of medical indications, denying a C-section request IS NOT considered a crime for the doctor.

It should be emphasized that the main goal of the delivery is wellbeing of the mother and the baby. (Cesarean section increases the risk for the mother and the newborn.)

Based on the conducted study, it was determined that expectant mothers receive the information, but it is not enough. A lack of personnel - to supervise the delivery process - results in a wrong decision by the mother (Cesarean section for the purpose of pain relief).

Various life experiences, personal pressures, painful delivery in the past, various pathological conditions in the antenatal period may lead to stressful changes, depression and excessive fear of "delivery pain." The community's, friend's, relative's experiences have a big influence on the expectant mother. The fear of "suffering" delivery still circulates throughout the community. Most likely, people are not aware of achievements in the field of Gynecology and Obstetrics. That is why we advise to inform not only the mother, but the whole community the advantages of natural delivery. It should be stressed that modern medicine has made big advances compared with the situation 20-30 years ago. It is possible that the lack of information is the reason why expectant mothers prefer (85%) to deliver through Cesarean section.

Acknowledgements

Based on the study, we are able to conclude that the number of Cesarean section has increased, and that the main contributing factor for it has been maternal request. The mothers and their relatives engagement in the decision-making process is high, which is the result of the following factors:

Expectant mothers do not possess sufficient information about the risks and benefits of C-section versus natural delivery;

Pain relief should not be the motivation for a C-section request - other options should be found;

(The expectant) mother should know the indications (relative and absolute) and possible complications (early and late) of C-section;

The information delivered to the patient should be clear and understandable, with full compliance with the Ethical Code; it is better to submit the information in the written form;

It is very important to increase the awareness of the advantages of natural delivery not only among expectant mothers, but also in the community. The Internet is available everywhere, and using it for the purposes of community education is a good strategy.

References

- JSI. (2008). *Reproductive Age Death Research*. [reprodukciuli asakis sikdilianobis kvleva]. Sakartvelo.
- World Health Organization. (2007). *WHO Recommended Interventions for Improving Maternal and Newborn Health*. WHO/MPS/07.05. Geneva: WHO; World Health Organization. (2000). *Managing Complications in Pregnancy and Childbirth*. Geneva: World Health Organization.
- World Health Organization. (2003). *Managing Newborn Problems: A guide for doctors, nurses, and midwives*. Geneva: WHO.
- World Health Organization. (2006). *Pregnancy, Childbirth, Postpartum and Newborn Care: A Guide for Essential Practice*. Geneva: WHO.
- World Health Organization, UNFPA, UNICEF and AMDD. (2009). *Monitoring Emergency Obstetric Care: a Handbook*. Geneva: WHO.
- Villar J, Valladares E, Wojdyla D, Zavaleta N, Carroli G, Velazco A, et al. (2006). *Caesarean delivery rates and pregnancy outcomes: the 2005 WHO global survey on maternal and perinatal health in Latin America*. *Lancet*;367(9525):1819–29.
- Villar J, Carroli G, Zavaleta N, Donner A, Wojdyla D, Faundes A, et al. (2007). *Maternal and neonatal individual risks and benefits associated with caesarean delivery: multicentre prospective study*. *BMJ*; 335(7628):1025.
- Henderson J, McCandlish R, Kumiega L, Petrou S. (2001). *Systematic review of economic aspects of alternative modes of delivery*. *BJOG*;108 (2):149–57.
- Essen B, Johnsdotter S, Hovellius B, Gudmundsson S, Sjoberg NO, Friedman J, et al. (2000). *Qualitative study of pregnancy and childbirth experiences in Somalian women resident in Sweden*. *BJOG*;107 (12):1507–12.
- Ezechi OC, Fasubaa OB, Kalu BE, Nwokoro CA, Obiesie LO. (2004). *Caesarean delivery: why the aversion?* *Trop J Obstet Gynaecol*; 21:164–7.

- Dumont A, De Bernis L, Bouvier-Colle MH, Breart G. (2001). *Caesarean section rate for maternal indication in sub-Saharan Africa: a systematic review*. Lancet; 358(9290)
- Shah A, Faundes A, Machoki M, Bataglia V, Amokrane F, Donner A, et al. (2008). *Methodological considerations in implementing the WHO Global Survey for Monitoring Maternal and Perinatal Health*. Bull World Health Organ; 86(2): 126–31.
- Ronsmans C, Holtz S, Stanton C. (2006). *Socioeconomic differentials in caesarean rates in developing countries: a retrospective analysis*. Lancet; 368(9546):1516–23.
- Belizan JM, Althabe F, Barros FC, Alexander S. (1999). *Rates and implications of caesarean sections in Latin America: ecological study*. BMJ; 319(7222):1397–400.
- Pai M, Sundaram P, Radhakrishnan KK, Thomas K, Muliyl JP. (1999). *A high rate of caesarean sections in an affluent section of Chennai: is it cause for concern?* Natl Med J India; 12(4):156–8.
- Sreevidya S, Sathiyasekaran BW. (2003). *High caesarean rates in Madras (India): a population-based cross sectional study*. BJOG; 110(2):106–11.
- Wanyonyi S, Sequeira E, Obura T. (2006). *Caesarian section rates and perinatal outcome at the Aga Khan University Hospital, Nairobi*. East Afr Med J; 83(12):651–8.
- World Health Organization. (2005). *The World Health Report 2005: Make every mother and child count*. Geneva: WHO.

Business and Economics

ქართული ბრენდები - შემთხვევითობა თუ წინასწარ დაგეგმილი სტრატეგია

*ბიბილაშვილი ლელი
საქართველოს უნივერსიტეტი*

დღესდღეობით ბრენდს კომპანიების წარმატებასა და წარუმატებლობაში უმნიშვნელოვანესი ადგილი უჭირავს. თუმცა, თითოეული წარმატებული ბრენდის მიღმა უამრავი შეცდომა დგას, ბრენდები ასე ადვილად და მარტივად არ ყალიბდება. ბრენდის წარმატება სწორად დაგეგმილ სტრატეგიაზე და მის განხორციელებაზეა დამოკიდებული. სტატია მიმოიხილავს ბრენდს, მისი განვითარებისა და მართვის თავისებურებებს და წარმოადგენს ქართულ რეალობაში არსებულ ვითარებას ბრენდინგის თვალსაზრისით. კერძოდ, სტატიაში მოცემულია მტკნარი წყლის ბრენდებად ქცევის ამხსნელი ფაქტორები. სტატიაში მოცემული ინფორმაცია თვისობრივ კვლევას ეფუძნება და ძირითადად ბრენდის პერსონიფიკაციის, პირველადი და მეორადი ასოციაციების შესწავლის შედეგად კონკრეტულ დასკვნებს გვთავაზობს. სტატიაში, ამასთანავე განხილულია ბრენდის რაციონალური შეფასებებიც. სტატიაში მოცემულია მცდელობა ხაზი გაესვას საქართველოში ბრენდინგისადმი სტრატეგიული მიდგომის საჭიროების განსაზღვრას, რადგან კვლევის საფუძველზე მკვეთრად იკვეთება, რომ საქართველოში ის ერთეული პროდუქტებიც კი, რომელიც ბრენდად იქცა სრულიად შემთხვევითი ფაქტორების წყალობით გადაიქცა ბრენდად და არა ინტენსიური მარკეტინგული თუ სტრატეგიულად დაგეგმილი სწორი კომუნიკაციის შედეგად. ბრენდების, როგორც რაციონალური, ისე პერსონიფიცირებული შეფასების დროს საკმაოდ ცხადი ხდება, რომ საკომუნიკაციო აქტივობები საკმაოდ სპონტანურ ხასიათს ატარებს.

Georgian Brands – Casually or Intentionally

Bibilashvili Leli
The University of Georgia

Brands are powerful weapons transforming commercial force. Today brands are everything, and all kinds of products and services are figuring out how to transcend the narrow boundaries of their categories. To build sensitive brands with strong, persuasive and long-lasting values is far from easy. For every branding success there are a great many failures. Relationships are not quickly and easily built. You can't fake them.

The origins of modern branding go back several centuries, when producers and shopkeepers started to do business under their family names. As early as 1575, Lucas Bols started selling his liquor using his family names, in 1743 Claude Moet and Pierre Gabriel Chandon began selling their champagne, in 1759 Josiah Wedgwood his porcelain, in 1780 Johann Jacob Schweppes his tonic.

But brands as we know them today developed in combination with the industrial revolution in the 19th century. Many of today's brand leaders were founded in the 19th century: Colgate in 1806, Johnny Walker in 1820, Siemens in 1847 and so on. Initially their names were no more than guarantee of the quality and quantity of their products. With the emergence of mass media and advertising, these companies began to discover the influence which their names could exert in the marketplace and branding developed into a real business tool.

Brands in their modern sense originated in the mid-19th century. Since then, branding has evolved through a number of stages to reach the dominant role and position it has today. Six stages can be distinguished:

1850 – Identification Branding

The early brands represented the makers of categories and products. Their primary function was to give security about quality, quantity, composition and price. Competition was based on generic attributes.

1950 – Benefit Branding

Brands became representatives of unique product attributes. Different brands were developed to represent different attributes. Segmentation and positioning became the new ideologies of brand management.

1970 – Symbolic Branding

It was realized that a brand "image", independent from the product, often had a stronger influence on the consumer's choice than the product's attributes. Brands became representatives of psycho-social mean-

ings, with personalities and values, and consumers used the brand to express their own identity and self-image.

1990 – Experience Branding

The 1990s could be considered the decade of abundances and product performance and even psycho-social meanings became commodities. Pine and Gilmore welcomed consumers in the new experience economy. Brands now had to offer multi-sensory experiences.

1995 – Societal Branding

Branders became aware that they had a larger responsibility in society than just producing profit, paying taxes, employing people and obeying all laws. Citizens now expected them to contribute to broader societal goals as well.

2000 and beyond: Total branding

Branding is no longer just a marketing tool. It has become a summary of everything a business is, does and wants to be. “Brand Based Strategic Management” is the new idea, with the brand as the point of departure for the business strategy. Vision and mission are the leading branding principles. And everything about the brand has to be integrated into a harmonious whole. The brand has become a fully integrated piece of art.

According to AMA (American Marketing Association) a brand is a “name, term, sign, symbol, or design, or a combination of them, intended to identify the goods and services of one seller or group of sellers and to differentiate them from those of competition.”

The key to creating a brand, according to AMA definition, is to be able to choose a name, logo, symbol, package design (brand elements), or other characteristics that identifies a product and distinguishes it from others.

Success of brands depends on correct strategic brand management process, which involves the design and implementation of marketing programs and activities to build, measure, and manage brands. But what is meant by correct brand concept and communication strategy. Several models exist that try to explain how to manage brands properly, but nowadays the most popular and widely used is Tomas Gad’s 4D Branding model. According to this model successful companies will be those that live the brand – because they are the brand. To understand the brand fully, to live it and enable customers to live it means creating brand’s own brand code. To do so requires using a four-dimensional model to understand the strengths and weaknesses of the brand. The four dimensions are: functional, social, mental and spiritual. By looking at brands in 4-D, organizations can create a brand code that can drive every aspect of the business-from product innovation to recruitment. Brand code equals differentiation. To be different is a biological drive, naturally people seek to be different to avoid degeneration. Business life is nothing but an exten-

sion of other forms of life. In business, differentiation is equally important. If you're not different in business, your whole existence is in danger, you will be replaceable and under constant pressure to lower the price. Sometimes the only difference you need is not in the product you deliver, but in the way it is delivered.

Consumers use brands in the same way as actors use theatrical props to augment and clarify their role and personality. A single consumer has may have multiple behaviors depending on which role is appropriate at that moment. The most important criteria when choosing a brand are not static; rather they depend on the situation. While working on brand concepts and positioning, one should consider mental, social, functional and spiritual dimensions. These dimensions are brand appeals for customers.

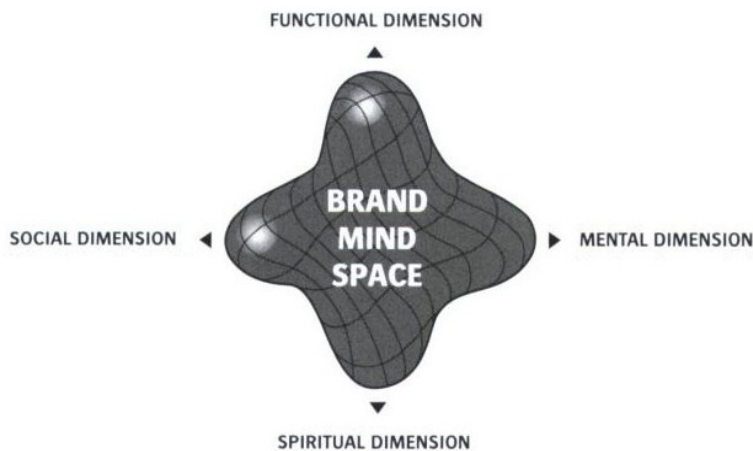

The functional dimension concerns the perception of benefit of the product or service associated with the brand. Almost always, the need to build a brand starts with making a more or less unique product or service, and the benefit for the customer is the basis for the brand. That is the perceived benefit, not necessarily the real benefit that the inventor or the engineer had in mind, but the one actually experienced by the customer.

The social dimension concerns the ability to create identification with a group. Social life and social acceptance are the most important part of people's lives. Buyers in any market make their purchase decision subjectively; basing it on what they feel best conveys or portrays their social identity.

With growing instability in society, brands appear to take over as identifications. The traditional class society is dying and instead we are moving to a kind of "branding society". In the social dimension the brand

quite often creates a cult around itself, it becomes a social insignia, or a “prop” in the lifestyle play of an individual.

The mental dimension is the ability to support the individual mentally. This dimension is by its nature a much more profound dimension: it really penetrates deep inside one’s personality. Here the brand touches what the most of us would call our soul. It is about personal transformation. It’s about change and getting new insights about yourself. All individuals need to have role models on which to model their life and behavior. The brand and its mental dimension serve that purpose. Experiences from early childhood up to the present day largely set our personalities, reactions and behavior. Sometimes this results in low self-esteem in certain areas of life. Help with reframing these mental pictures of ourselves is very important to us, and therefore a great opportunity for a brand builder.

The spiritual dimension is the perception of global or local responsibility. Spiritual refers to the larger system of which we are all a part.

To tell simply, after building 4-D branding model, main messages according to these dimensions and main differentiators of brands, one begins planning correct communication strategies, namely which communication channels to use, by what intensity and how to deliver to relevant segment main messages.

Not even using 4-d dimension model, one should have competitor analysis and main differentiating messages for communication. It’s interesting if Georgian brands do use any branding model and if they have what results they are getting. For that reason I have conducted qualitative research, namely focus groups mainly in youth on Georgian still water brands. The goal of the research was to find out how different the brands of the same product category are positioned, attitude towards brands, rationale evaluation, determine brand success and how well their brand concepts and communication tactics are planned.

Because leaders on Georgian still water market are: Bakuriani, Borjomi Springs and Bakhmaro, I concentrated mainly on these leader brands.

Brand	Share of consuming	Volume of consuming
<i>Bakuriani</i>	<i>60%</i>	<i>33%</i>
<i>Bakhmaro</i>	<i>55%</i>	<i>23%</i>
<i>Borjomi Springs</i>	<i>55%</i>	<i>22%</i>
<i>Racha Waters</i>	<i>42%</i>	<i>16%</i>
<i>Bonaqua</i>	<i>20%</i>	<i>6%</i>

Borjomi Springs - Free associations and personification

Free associations indicate leadership of “Borjomi Waters” on Georgian still water market.

Customers directly relate Borjomi Springs to its location. Positive attitude regarding “Borjomi” which is formed on the basis of Borjomi history and experience usually is reflected on “Borjomi Spring” as well.

Personified “Borjomi Waters” stand out with leadership feature. Brand Person is characterized as influential, powerful, self-confident person who has achieved a lot and continues succeeding. This kind of description indicates that “Borjomi Springs” is one of the most successful player on Georgian still water market, though as mentioned above such perception is not conditioned by “Borjomi Springs” special or unique positioning, but is influenced by “Borjomi mineral waters” image.

“Borjomi Springs” as a Person

Origins, Demographic characteristics, appearance, Dressing 60-65 years old man, who has achieved a lot but still tries to do something for people. Old man with white beard, but always looking and feeling young. Will never fade.

Positive Personal Characteristics Smart, calm, balanced, businessman, self-confident, influential, powerful, monopolist, provident, well settled with successful future. Family man, has grandchildren. Handsome, healthy, bright minded. Traditional.

Negative Personal Characteristics Unarranged, rough, dreary.

Lifestyle Professor, Doctor, Businessman.
Lives in wooden house like hunters hut, in ecologically clean environment, surrounded by flowers.

Rationale evaluations

While evaluating “Borjomi Springs” respondents underlined the Brands strong and weak sides. Advantages of “Borjomi Springs” are long lasting history of existence, what emphasizes company’s experience and establish customers trust towards products quality and attractive bottle design

Bakhmaro - Free associations and personification

“Bakhmaro” still water is associated with relax, height, cold weather, fresh air, in other words to the memories and impressions related to resort Bakhmaro.

Compared to “Borjomi Springs”, in youth segment “Bakhmaro” brand characteristics are less dynamic and energetic. The focus group respondent mentioned that Bakhmaro is quite calm resort where people go to have some rest and that way is “Bakhmaro” water perceived

“Bakhmaro” as a Person

Origins,	Old Man with beard.
Demographic characteristics,	Lonely.
appearance,	Tall, with bright teeth.
Clothing	
Positive Personal Characteristics	Helps people in health issues, caring and hard worker. Cheerful, experienced, respected.
Negative Personal Characteristics	Distant, never smiles, uncommunicative, closed person.
Lifestyle, Living Place	Shepherd, lives alone, rejected from others, lives in a hut, has a sheep-dog.

Person-Bakhmaro is an old man, who living in a calm environment and is less communicative with others. On the other hand he has a great experience in life and people respect him. Research data indicate that Bakhmaro is not discussed as a brand having big potential for development. While describing brand, respondents mentioned that they don’t think that brand will have a successful future.

That kind of description indicates that consumers don't perceive Bakhmaro as a modern and developing brand, despite this, in general, they have positive attitude.

It's worth to mention, that characteristics of brand like caring, healthy, cheerful indicate that like all other abovementioned brands Bakhmaro is perceived as wholesome for health.

Rational Evaluations

Research respondents while evaluating the brand rationally directed their attention on brands advantages and disadvantages, bottle design attractiveness and delicious taste. As respondents stated Bakhmaro is closer to natural water taste.

Regarding disadvantages the major complaint respondents had were following: lack of marketing activities, bad distribution.

Bakuriani - Free associations and personification

Primary associations related to Bakuriani are positive. Mainly, positive emotions are influenced by product name. Associations like snow, rest, resort, relaxing, ski, playing snowballs are in direct connection with brand's name and positive memories associated with Bakuriani resort.

"Close your eyes while drinking Bakuriani and imagine yourself in Bakuriani"

Free associations technique demonstrates that brand characteristics are influenced by brand name, Bakuriani brand is characterized as clean, pure and cooling water.

"Bakuriani" as a person

Origins,	Teenager
Demographic characteristics,	Young man (30-35 years old)
appearance,	Gray haired man (60 years old)
Clothing	Tall, classical dressing
	Snowman
Positive Personal Characteristics	Decent, free, sociable, communicable, active, sportive, athletic, healthy, nature loving, kind, caring, useful.
Negative Personal Characteristics	Not punctual, unserious.
Lifestyle	Sportsman, skier, champion. Businessman Lives in wooden house with fireplace; lives in ice palace.

Personified brand's characteristics like kind and caring indicates perceived usefulness on health of brand.

In most cases personified brand Bakuriani is family man with wife and small children and is committed to them. That kind of association emphasizes the fact that Bakuriani is mainly consumed by little kids in families.

„For me he is a family man, has 1 child and wife, he devotes his whole life to children”

Associations like tardiness and unpunctuality indicates on its less organized distribution system, and is explained by its unstable availability in stores.

”It delays, because sometimes we can't see him in stores”

Associations like young and energetic indicate that brand is mostly perceived for youth segment. Such perception can be explained more by its name rather than its positioning.

Rationale Evaluations

Research respondents while evaluating the brand rationally directed their attention on brands advantages and disadvantages. While listing brand's benefits they stated its taste and origin.

„When ice melts, water from melted ice is very wholesome for health and organism, all bacteria die.

Conclusion

Research of still water market gave us a following result; these are the products which became brands mostly by environmental factors, rather than by correct and intensive planning and communication. Brand images are mainly established by their names indicating place of origin, and associations related to these resorts.

Companies of abovementioned brands have low intensity in communication activities, besides this positioning and image of brands is elusive. No defined niche is taken by still water products.

As a matter of fact still waters are influenced by mineral water brand characteristics. E.g. Borjomi Springs are influenced by Borjomi mineral waters brand and Bakhmaro is influenced by Nabeghlavi mineral waters brand positioning.

Research shows that customers are not loyal to one or the other brand, due to the fact that there is no concrete reason for it, as on one hand consuming one of the brands is mainly provoked by habit and on the other hand there are no product specific characteristics defined by customers like taste. And the last but not the least there's no distinct brand appeal for customers, because of irrelevant brand concept planning and communication tactics.

References

- Kapferer, Jean-Noel. (2007) *The New Strategic Brand Management*. UK, London, London and Sterling Kogan Page
- Keller, K. (2008) *Strategic Brand Management*. USA, New Jersey; Pearson, Prentice Hall
- Mark, M.(2005)*The Hero and the Outlaw- Building Extraordinary Brands through the Power of Archetypes*. USA, NY; MCGRAW HILL
- Peters, T. (2001)*The Brand You 50*. USA, NY; MCGRAW HILL
- Ramos, V. Jaccard, James, D. Gonzalez, P. (2000) *Unified Theory of Behavior*. Upper Saddle River, New Jersey; Pearson, Prentice Hall

საბაზრო მექანიზმები და ჯანდაცვის სერვისების მიწოდება

კაკუბავანი ნინო

საქართველოს უნივერსიტეტი

ნაშრომი მიმოიხილავს ე.წ. „ნახევრად-ბაზრების“ დანერგვასა და განვითარებას გაერთიანებული სამეფოს ეროვნული ჯანდაცვის სისტემაში. ნახევრად-ბაზრები წარმოადგენს ერთ-ერთ საბაზრო მექანიზმს, რომლის დანერგვაც დაიწყო 1990-იან წლებში და რომლის თანახმადაც მოხდა ჯანდაცვის სერვისების მყიდველებისა და მიმწოდებლების გამოჯვანა. ნაშრომში იკვლევს სანახევროდ-ბაზრების სარგებლიანობას ჯანდაცვის სერვისების მიწოდებაში. სარგებლიანობის განსაზღვრა ხდება ხუთი ძირითადი კრიტერიუმის მიხედვით: ეფექტიანობა, თანასწორობა, ხარისხი, არჩევანის შესაძლებლობა და ანგარიშვალდებულება. შესაბამისად, თოთოეული კრიტერიუმის გაუმჯობესება ან /და გაზრდა განიხილება, როგორც სარგებლიანობის ზრდის მაჩვენებელი.

Can Markets Benefit Public Health Services?

Kakubava Nino

The University of Georgia

Since the establishment of the NHS in 1948 until recently, by far the largest part of the UK health care had been provided by the public sector. The decisions how much should be produced and how this production should be allocated were made not by ‘self-interested’ individual producers and consumers competing with each another but by politicians and professionals operating in a bureaucratic environment (Le Grand and Bartlett, 1993, p. 1).

Because of the sensitivity attached to health and health care, traditionally it was considered unethical to apply economic analyses to it (Le Grand, Propper & Robinson, 1993, p36). Even under the Thatcher government obsessed with the introduction of the market style mechanisms into welfare provision, the health care system remained largely intact until the late 1980s (Le Grand and Bartlett, 1993, p. 2).

The “big bang” occurred with the reforms of the late 1990s, when the government introduced internal or quasi-markets into the health care, under which the purchasers and providers were separated (Le Grand, 1991, p. 1258). The key words of the reforms were choice and competition, choice for patients, and competition among providers. The underlying rationale was that competition would compel providers to be more efficient and more responsive; otherwise, they would be forced to leave the market (Klein, 1998).

However, the health care system came under scrutiny once again when the Labour government came to power and officially abolished internal markets with the publication of the White Paper in 1998 (Le Grand, 2002). The purchaser/provider split was retained but the system based on competition was replaced by the system “based on cooperation;” and collaboration and contestability became new key words (Klein, 1998).

These developments raised many questions that have been hotly debated. Why the reorganization again? Did internal markets prove unable to provide any improvement to health services? Can they generally benefit public health services?

To answer this questions, the paper provides theoretical as well as empirical considerations. Namely, I will examine the origins of the internal markets and theoretical speculations about the potential benefits they might have and then I will test these speculations against empirical data from the UK experience.

Understanding the Quasi-Market Phenomenon

The reforms to the NHS, outlined in the Working for Patients, came into legislation on 1 April 1991 in the form of the Community Care Act. However, the origins of the reforms can be traced back to the early 1980s, when Mrs. Thatcher created an environment, which “valued wealth above welfare, markets above bureaucracies, and competition above patronage” (Butler, 1993, p. 14).

There are many explanations for the introduction of the internal markets. The policy climate under the Thatcher government along with the growing criticism of the NHS in terms of micro-inefficiency (Barr, 2004, p. 286) were two main factors that eventually led to the introduction of the quasi-markets (Bartlett and Harrison, 1993, p. 69). Central to Mrs. Thatcher’s philosophy was that monetary control and competition were main tools for controlling macro- and micro-economy, respectively. The competition was deemed necessary to generate constant pressure for efficiency and keeping prices down. The state was believed to have no place in the market and therefore public sector monopolies became the target for change through privatization - selling off major state assets to private sector shareholders (West, 1997, p. 2).

While it was easier for the government to get rid of public monopolies in industries such as transport, energy, telephone and so on, it was not the case in education and health, services believed to be ethically sensitive. "If privatization was not an option in the achievement of better performance in health and education, policy needed to find other ways of achieving uniformly high efficiency" (West, 1997, pp. 2-5). So, the offer was "competition without privatization", i.e. establishment of the purchaser-provider split, a suggestion of an influential critical analysis of the NHS by the American health economist Alan Enthoven (Glennerster, 1997, p. 187).

Glennerster notes that the quasi-market was a solution to the failure of both market as well as government in meeting needs and wants in an efficient way. The basic idea was to keep services free at the point of use and finance them out of taxation, but let agencies compete to provide those services (Glennerster, 2003, p. 30).

The term quasi-market was coined by Williamson, although it is generally associated with the work of Le Grand and Bartlett (Powell, 2003). According to Le Grand and Bartlett the quasi markets are "markets" in the sense that they replace monopolistic state providers, and are "quasi" because they differ from conventional markets in a number of ways (1993, p. 10). On the supply side, there is competition between NHS Trusts (providers) and on the demand side consumer purchasing power is exercised by GP Fundholders and by DHAs (purchasers). The interaction between them is on the bases of contracts (Robinson and Le Grand, 1995, pp. 26-28).

Evaluation of the internal markets in the Health Care

To judge whether internal markets can benefit public health services, first we need to define what we mean by "benefit" and set out criteria against which quasi-market policy should be evaluated. Le Grand and May (1998) proposed five main criteria for this reason: Efficiency, equity, quality, choice and responsiveness, and accountability (pp. 15-17). Those criteria will be further used for evaluation and consequently, any increase and/or improvement of them will be considered as beneficial to health services. Our assessment is based on the theoretical as well as empirical considerations.

Predictions and theoretical speculations about the internal markets were mostly optimistic. It was recognized that contracting would lead to increased transaction costs, but still, it was believed that efficiency gains in service delivery due to competition would more than offset them (Robinson and Le Grand, 1995, p. 37). Commentators argued that internal markets might well benefit health services in terms of increased effi-

ciency, if they met certain conditions. The most important was that they should have been competitive (Le Grand and Bartlett, 1993, pp. 13-34).

However, the fulfillment of these conditions in practice proved difficult, if not impossible. The early empirical assessment, provided by Bartlett and Harrison on the bases of the Bristol and Weston Health authority case study, was disappointing. The lack of purchasers and providers led to the prognosis that quasi-markets are likely to fail to operate in a competitive fashion in many local areas (1993, p. 88). Later assessments of the reforms provide various results and it is worth discussing them separately according to our set of criteria.

Efficiency

One of the main criticisms of the NHS before quasi-markets was that it was inefficient. Critics argued that the cost of services in a monopolistic public market was twice as high as in a competitive market (Boyne, Farrell, Law & Richard, 2003, p. 16). There are two definitions of efficiency proposed by economists: technical or productive efficiency and allocative efficiency. Technical efficiency is defined as the ratio of service "inputs" to "outputs" and usually measured by the "unit cost" – resources required to produce a "unit" of good or services. Allocative efficiency is the match between the outputs and preferences of the public and is mainly assumed by the purchaser side (Boyne, Farrell, Law & Richard, 2003, pp. 16-17).

According to Le Grand (1999), the CWAI is the only indicator on which the evaluation of the overall productive efficiency of the NHS could be based. The CWAI is obtained by aggregating the activity rise in various areas of hospital and community health services, each weighted by the proportion of resources they receive (DoH, 1996). Muligan (1998) examined the changes in the activity measured by the CWAI over the period before and after the introduction of internal markets and revealed that the activity started rising faster after the reforms. Moreover, there was a greater increase in activity than in real resources after the reforms (p.23), which means that the cost per activity decreased and consequently, the overall productive efficiency increased (Le Grand, May & Mulligan, 1998, p.120). Le Grand (1999) argues that the efficiency increased despite considerable increases in transaction and management costs. Even more, since the management costs are included in the overall costs of resources and the activity increased more rapidly than the resources overall, "any cost-inflationary impact from the increase in these costs was more than outweighed by other positive factors contributing to greater efficiency".

With respect to separate parts of the internal market, Goodwin (1998) assessed the technical efficiency of fundholders by using proxies such as prescribing cost, referral rates and savings (p. 45). Government

hoped to reduce wasteful prescribing costs and inappropriate referral rates by imposing budgetary pressure. Indeed, the data analysis undertaken by Hurriss and Scrivener (1996) showed that the English fundholders were more cost-effective prescribers than non-fundholders and they made greater savings than DHAs, although changes in referral rates were more difficult to observe since different studies suggested different results (Goodwin, 1998, pp.49-51). However, despite this kind of improvements, as Le Grand (1999) points out, studies do not show whether they outweigh any associated increase in costs or not, and therefore we cannot judge if the unit cost decreased, which is a proper definition of efficiency.

As for the allocative efficiency, there is no properly documented evidence to build a national picture (Mulligan, 1998, p.26), although there was a clear shift in the provision of care from the secondary to the primary level under the internal markets and GP fundholders appeared to serve as a catalyst in this process (Goodwin, p. 52).

Equity

Striving for equity, “an almost universally recognized goal in health care” (Appleby, 1992, p. 13), was one of the principal motivations that led to the establishment of the NHS in 1948. Broadly speaking equity means equality of opportunity (Barr, 2004, p. 255), i.e. equal access to care for everyone on the basis of need regardless any other factors such as income, race, class, gender, etc. (Le grand, Mays & Mulligan, 1998, p. 76).

While other criteria were expected to improve under the internal market, the equity by contrast was feared to be eroded (Saltman and Van Otter, p. 9). However, some aspects of reforms, not directly concerned with the introduction of competition but rather related to the health promotion based on the assessment of needs, were heralded as beneficial in terms of equity. Namely, it was assumed that the assessment of needs would highlight inequalities in health and in provision and having purchasers as “champions of people”, who would use this assessment, as the bases for resource allocation, would eventually lead to a more equitable allocation of resources; so, “market could be used as a positive tool to achieve greater equity” (as cited by Whitehead, 1993, p. 214). However, there is no evidence available to back up this argument at the national level (Whitehead, 1993, p. 231). By contrast, there has been a growing concern that the market-oriented system is not compatible with equity principles and the main goal in this respect became to retain at least the same level of equity. So when evaluating the impact of the internal markets on equity, we need to examine whether improvements in other criteria, if any, take place at the expense of equity or not.

Two issues were widely discussed in relation to internal markets and its equity implications. First was the fear that the internal markets could lead to cream skimming – the deliberate selection of patients who were less costly to treat in order to protect budgets. However, there is no evidence that cream skimming took place under the internal markets, on either the purchaser or the provider side (Propper, 1998, pp.24-26; Le Grand, May & Mulligan, 1998, pp. 123-124; Le Grand, 1999). Second concern was the issue of so-called “two-tierism” whereby patients of GPFHs get preferential treatment over the patients covered by DHAs. Indeed, the evidence shows that better access to hospital care for GPFHs was more widespread (as cited by Dixon and Glennerster, 1995), however, Propper (1998) argues that these differences did not appear in response to the internal markets, rather they were determined by several other factors (p. 25). Furthermore, Le Grand, Mays & Mulligan (1998) claim that there is no evidence that internal markets resulted in patients of non-fundholdings being worse-off. Instead, quasi-markets achieved different rates of improvement for fund-holding and non-fundholding practices with better results for fund-holding patients, rather than absolute worsening for non-fundholding ones (p. 124). So generally, it is argued that quasi-markets did not sacrifice equity as feared by critics.

Quality

The competition was also expected to improve quality and “give patients a better care”. However, how to measure quality in health care is debatable since the term itself is multi dimensional and might be subject to many possible interpretations (Le Grand, May & Mulligan, 1998, p. 17).

In a study of the impact of competition on quality by Propper, Burgess & Green (2004), the death rates from acute myocardial infarction is used as a measure of quality. By using cross-sectional analyses based on several measures of competition and the average death rate for each hospital for the period 1995/6-1997/8 they found out that the hospitals facing more competition had higher death rates, i.e. lower quality. In another study, Propper, Burgess & Gossage (2003) used the same measures for competition and quality and a panel data set of all acute hospitals in England from 1991 to 1999. The overall result was the same: the impact of competition was to reduce quality (pp. 19-20).

Le Grand (1998) proposed two other indicators of quality such as patients’ satisfaction and waiting lists. According to the annual survey of the public’s attitudes to the NHS conducted by the British Social Attitudes Survey, although dissatisfaction with the overall running of the NHS fell from 47% in 1990 to 38% in 1993, it went up again and reached 50% in 1996 the highest level ever (pp. 124-127). As for waiting lists, they were increasing steadily in length before and after the introduction of the in-

ternal market. However, the mean waiting times were falling during the same period i.e. people were waiting for shorter periods and by 1993 almost no one was waiting more than two years (Le Grand and Wizard, 1998, pp.99-101). Overall, the average waiting time did not change under the quasi-markets and was broadly the same as before (cited by Le Grand, May & Mulligan, 1998, p.127)

Choice and Responsiveness

Another objective of the reforms, as set out in the Working for Patients, was “to give patients greater choice of services available”. It was argued that in the internal markets where providers, who compete with each other in order to secure contracts with purchasers, will have an incentive to attract patients and “money that follows them” and accordingly will make sure that they offer services which patients want (Mahon, Wilkin & Whitehouse, 1993, p.110). However, Mahon, Wilkin & Whitehouse, (1993) pointed out “if choice is expected to increase because of the introduction of a market ethos into the health service then disappointment is inevitable”. Indeed, the research project conducted at the early stage of internal markets and evaluating the impact of the NHS reforms on patients’ choices revealed little change during the first year of the reform (pp. 119-125). Later publications develop the same idea. According to Le Grand, May & Mulligan (1998) choice for patients did not increase under the internal marker, neither on the provider’s side, nor on purchaser’s side. With respect to responsiveness, the purchasers, namely GPFH, seem to have more success in obtaining responsiveness from providers but the overall change was also minimal (pp. 127-128).

Accountability

As far as health services were still funded out of general taxation under the internal markets it seems rational that purchasers and providers need to account for their activities to the funders. Two forms of accountability were mainly discussed in this respect: accountability to the centre and accountability to the local community and patients (Le Grand and May, 1998, p. 17). Overall, according to studies, there was more improvement in the upward accountability on both purchasers and providers sides and the accountability of the HAs to the center was higher than that of the GPs. However, the concern about the lack of accountability was growing, and even after several years since the launch of the internal markets it was generally regarded that accountability procedures must improve (Goodwin, 1998, p. 66).

Conclusion

Thus, from the discussion, we can see that there was some increase in efficiency, and what is important; the increase did not take place at the expense of equity. However, other criteria did not change much. Overall, there was little measurable improvement attributable to the internal market (Le Grand, 1999). Generally, the experiment was deemed to fail. However, some commentators still claim that the failure does not mean that internal markets cannot generally benefit health services; rather the failure was a result of the government's inability to create certain conditions necessary for internal markets to work properly. E.g., Klein (1998) argues that since it was the government, who was responsible for the consequences, it could not leave decisions to the markets so easily, which undermined the devolution of decision-making and impeded the establishment of competition -the central concepts of the market system. Le Grand (1999) goes even further, by claiming that in reality internal markets were never tried, instead there was a representation of one. The government simply "could not let go of the market that it had tried to set up" and consequently did not create proper environment for competition, the underlying condition for success; "In the battle between market competition and central control, control won".

Thus, from the discussion, we can conclude that in theory, internal markets can benefit health services in case certain conditions are met. However, it proved difficult to back up this argument by the empirical evidence from the UK internal market, since despite some improvements in terms of efficiency; the overall picture was mainly disappointing. Nevertheless, according to some commentators, the internal markets would have brought better results if they had been properly implemented. So generally it turns out that the failure was a result of inappropriate conditions which leads to the conclusion based on the initial prediction - internal markets can benefit public health services if they are implemented properly.

References

- Barr, N. (2004). *Economics of the welfare state* (fourth edition). Oxford, UK: Oxford University Press.
- Bartlett, W. & Le Grand, J. (1993). The performance of thrusts. In R. Robinson R. & J. Le Grand (Eds.), *Evaluating the NHS reforms*. King's Fund Institute.
- Bartlett, W. and Harrison L. (1993). Quasi markets and National Health Service reforms. In J. Le Grand. & W. Bartlett (Eds.), *Quasi-markets and social policy*. The Macmillan Press LTD.
- Boyne, G. A., Farrell, C., Law J., & Richard, W. M. (2003). *Evaluating public management reforms: principles and practice*. Open University Press.
- Butler, J. (1993). Origins and early developments. In R. Robinson & J. Le Grand (Eds.), *Evaluating the NHS reforms*. King's Fund Institute.
- Dixon, J. & Glennerster H. (1995). What do we know about fundholding in general practice? *British Medical Journal*, 311 (7007). pp. 727-730
- DoH, (1996). *The government expenditure plans 1996/97 to 1998/99*. London: HMSO.
- Glennerster, H. (1997). *Paying for welfare: towards 2000* (third edition). Prentice Hall.
- Glennerster, H. (2003). *Understanding the finance of welfare: what welfare costs and how to pay for it*. The Policy Press.
- Goodwin, N. (1998). GP fundholding. In J. Le Grand, N. Mays & J. Mulligan (Eds.), *Learning from the NHS internal market*. King's Fund.
- Hurris, C. & Scrivener G. (1996). Fundholder's prescribing costs: the first five years. *British Medical Journal*, 313, 1531-1534.
- Klein, R. (1998). Why Britain is reorganizing its National Health Service – yet again, *Health Affairs*. 17 (4), 111-125.
- Le Grand, J. & Bartlett, W. (1993). *Quasi-markets and social policy*. The Macmillan Press LTD.
- Le Grand, J. & May N. (1998). Methods. In J. Le Grand, N. Mays & J. Mulligan (Eds.), *Learning from the NHS internal market*. King's Fund.
- Le Grand, J. & Wizard P. (1998). The NHS: crises, change or continuity? In H. Glennerster & J. Hill (Eds.). *The state of welfare*. Oxford University Press.
- Le Grand, J. (1991). Quasi-markets and social policy. *The Economic Journal*, 101, 1256-1267.
- Le Grand, J. (1999). Competition, cooperation or control? Tales from the British National Health Service. *Health Affairs*. 18 (3). pp. 27-39
- Le Grand, J. (2002). Further Tales from the British National Health Service. *Health Affairs*, 21 (3). pp. 116-128
- Le Grand, J., Mays, N., & Mulligan, J. (1998). *Learning from the NHS internal market*. King's Fund.

- Le Grand, J., Propper, C., Robinson, R. (1993). *The economics of social problems* (third edition). Macmillan.
- Mahon, A., Wilkin, D. & Whitehouse, C. (1993). Choice of hospital for elective surgery referrals: GPs and patients' views. In R. Robinson & J. Le Grand (Eds.), *Evaluating the NHS reforms*. King's Fund Institute.
- Mulligan, J. (1998). Health authority purchasing. In J. Le Grand, N. Mays & J. Mulligan (Eds.), *Learning from the NHS internal market*. King's Fund.
- Powell, M. (2003). Quasi-markets in British health policy: a longue duree perspective. *Social Policy and Administration*, 37(7), 725-741.
- Propper, C. (1998). Who pays for and who gets health care? Equity in the finance and delivery of health care in the United Kingdom. *Nuffield Occasional Papers Health Economics Series: Paper No.5*. The Nuffield Trust.
- Propper, C., Burgess, S., & Green, K. (2004). Does competition between hospitals improve the quality of care? Hospitals death rates and the NHS internal market. *Journal of Public Economics*, 88, 1247- 1272.
- Propper, C., Burgess, S.M., & Gossage, D. (2003). Competition and quality: evidence from the NHS internal market. *CMPO Working Paper Series No. 03/077*
- Robinson, R. & Le Grand, J. (1995). Contracting and the purchaser-provider split. In R.B. Saltman & C. Von Otter (Eds.), *Implementing planned markets in health care*. Open University Press.
- Saltman, R.B., & Von Otter, C. (Eds.). (1995). *Implementing planned markets in health care*. Open University Press.
- West, P. (1997). *Understanding the National Health Service reforms*. Open University Press.
- Whitehead, M. (1993). Is it Fair? Evaluating Equity Implications of the NHS Reforms. In R. Robinson & J. Le Grad (Eds.), *Evaluating the NHS reforms*. King's Fund Institute.

კულტურული თანამშრომლობა, როგორც ეკონომიკური დემოკრატიის საფუძველი

მელიქიანი ნარინე
ეკონომიკის დოქტორი

აღნიშნული კვლევა მიზნად ისახავდა კორპორაციული კულტურის, როგორც სისტემის შექმნის საშუალების შესწავლას და დაკვირვებას, რომელიც უზრუნველყოფს ეკონომიკური დემოკრატიის და „საზოგადოებრივი მზადყოფნის“ გაძლიერებას სომხეთში. ამ მიზნით, სომხეთში კორპორაციული კულტურის ფორმაციის მიმართულეებით არსებული გამოცდილება შეისწავლეს და განსაზღვრეს მისი თავისებურებები, გააანალიზეს საჯარო სტრუქტურებისა და სამთავრობო წარმომადგენლების დამოკიდებულება და მიდგომები სომხეთის კორპორაციული კულტურის მიმართ, შეისწავლეს და შეაფასეს საქმიანი წრეების, საზოგადოების, და სამთავრობო წარმომადგენლების მოსაზრებები იმის თაობაზე, განიხილავდნენ თუ არა ისინი კორპორაციულ კულტურას, როგორც დემოკრატიული ეკონომიკის გაუმჯობესების მექანიზმს. ამასთანავე, მხედველობაში მიიღეს შემოთავაზებები როგორც კულტურული თანამშრომლობის განვითარების, ასევე დემოკრატიული პრინციპების სრულყოფისათვის.

Corporate Culture as the Basis of Economic Democracy

Melikyan Narine

PhD of Economics

The democracy is the government of the people by the people for the people

Abraham Lincoln

As evidenced by existing experience of democratic countries, a steady democratic system is considered to be the best guarantee for political stability, which is very important for economic growth and development of private sector, for reinforcement of democratic values, such as transparency and responsibility, which are, at the same time, essential conditions for effective economic policy.

The economic democracy can be considered as the material foundation for political democracy. It is characterized as a system of economic relations, the main goal of which is to provide each individual with free selection of job conditions, decision making, and to ensure fair and informed participation in the latter, having an aim to establish democratic values in the economic life, to protect the fundamental human rights, to strengthen the supremacy of law, to promote welfare and to raise the quality of life. The economic democracy also aims to unify private, group and public interests, to combine personal undertaking and competitiveness, self-regulatory mechanisms and the public regulation, and to encourage private entrepreneurship.

Extensive implementation of democratic principles in the economic life has been largely contributed by the development of joint-stock companies. Under modern conditions the following can be considered as economic democracy promotion mechanisms: "Corporate Governance", "Corporate Social Responsibility", "Corporate Culture" and other related concepts and mechanisms, which in essence are strategic concepts of public and business relations targeted at securing stable and effective development of the society and business activities, as well as at the positioning of business activity in public relations as a "corporate citizen".

Despite the tendencies of growing interest and concern with respect to "shareholder democracy" in Armenia, the corporate culture has not so far become a subject of examination in the Armenian organizations. The study of this issue has become pressing due to the circum-

stance that under modern conditions the traditional vertical linear methods of governance implemented by the organizations prove to be inefficient, and they need to seek internal forces of development that would allow to orient certain subdivisions and employees towards general goals and values, combine employee initiatives, ensure commitment to the business, ease the relationship within the organization's staff, reduce uncertainty factor existing among the staff, reveal expectations of staff members, create a sense of participation, present the vision and development prospects of the organization, and motivate the employees towards progress. Besides, corporate culture underpins the creation of "social consensus" and enhancement of economic democracy.

Literature review

The term "corporate culture" was first used in the past century by German field marshal and military theoretician Moltke as a term characterizing the relations among officers (Maslennikov R., 2007).

The definitions clarifying the content and nature of corporate culture can be divided into three groups:

1. Definitions characterizing activities of the company and its employees (Hall R, 2001, Shein E, 2001),
2. Definitions characterizing corporate culture according to its elements (Eldridge J. and Crombie A., 1974, Hampton D., 1987),
3. Definitions representing corporate culture as an integral category (Gold K., 1982).

The essence of the corporate culture is revealed by the researches made in this sphere, which have a rather rich history. In general, three basic schools involved in the study of corporate culture are identified:

- *Behavioral school*: for the investigation of corporate culture the school representatives focus on the analysis of behavioral rules, values and principles arising during the work process (Cyert R. and March J., 1959, Hampton D., 1987).
- *Effectiveness school*: school representatives focus on the connection between the corporate culture and the effectiveness of the company activity (Peters T. and Waterman R., 1982, Deal T. and Kennedy A., 1982).
- *Modeling school*: corporate culture is accepted by the school as an independent object of research. This school representatives have developed corporate culture formation models, have proposed a corporate culture evaluation methodology,

as well as have given the classification of corporate culture, etc. (Cameron K. and Quinn R., 2001).

Based on above described theoretical provisions, in the present article we have attempted to detect the link between the corporate culture, as the inherent element of corporate social responsibility, and the economic democracy in the Armenian reality.

Project Study Description

The following are the sources of necessary information for the research:

- Results of survey conducted among business entities;
- Results of survey conducted among representatives of expert community.

The questionnaires were developed based on the Ten Principles of the Global Compact and the methodology of Organizational Culture Assessment Instrument (Cameron K. and Quinn R., 2001).

The need for combining these two techniques was conditioned by limited possibilities of implementing an expanded social survey. Besides, if the survey among business entities was intended to explore their experience in the formation and development of corporate culture, as well as to reveal their approaches towards the role of corporate culture in the establishment of democratic principles in the society, the survey conducted among experts had an aim to present the overall assessment and attitude of interested parties towards the adoption and implementation of corporate culture elements by Armenian business community.

Taking into consideration the fact that corporate culture is a significant tool for realization of CSR, such organizations were included in the sample of business entities which have positioned themselves in the Armenian reality as those displaying social responsibility and activeness. Therefore, UN Global Compact member companies were included in the sample, which was also supplemented with:

- banks, which, while not being UN Global Compact Members, due to the power of law have adopted such standards that are compliant with OECD CG principles, and are guided in their activity by above mentioned standards,
- organizations, the shareholders with significant participation of which are foreigners (e.g. EBRD), in consideration of the role of management technologies in the process of corporate culture formation and introduction of CSR elements.

The survey was conducted among 32 business entities. Therefore, it can be qualified as a pilot survey producing such outcomes which can

provide an insight into the general situation and can form a foundation for expanded research.

As regards the expert survey, the sample incorporated various individuals holding interest in the issue under consideration, such as individual experts, representatives of international and local institutions with a mission to elucidate CSR issues in Armenia, as well as representatives of NGOs, governmental authorities, mass media, consulting companies, and educational institutions. The sample of expert survey was formed according to the "snowball" effect, i.e. each expert selected in the main list of experts had noted, in his turn, 3 additional experts, who were included in the survey sample.

Key Outcomes

The research outcomes are presented according to the functions of corporate culture (Dubinin ĩ. 2002).

Formation of value system as a function of corporate culture

Definitions of corporate culture elements suggest that corporate values of a company constitute the core of its corporate culture, which forms the foundation for development of the company's rules and principles of conduct.

Survey results evidence that key corporate values for the surveyed companies are as follows: consumers (22%), teamwork (16%), shareholder welfare (16%), and company's image (13%) (Figure 1). This suggests that companies are oriented towards tangible values, namely wealth and respect (Erasov B., 2000). It should be noted that the 16% of the companies has emphasized the importance of shareholder's prosperity as a corporate value, which can be explained by the specifics of the Armenian type of CG system, when the owner's influence is decisive both for the company activities and for distribution of the results. Almost the same situation is observed in the expert survey results (Figure 1). However, in contrast to the surveyed companies, the 46% of experts have given their priority to the value of respect (goodwill and image), and 39% to the consumers.

Figure 1. Main corporate values of the Armenian companies

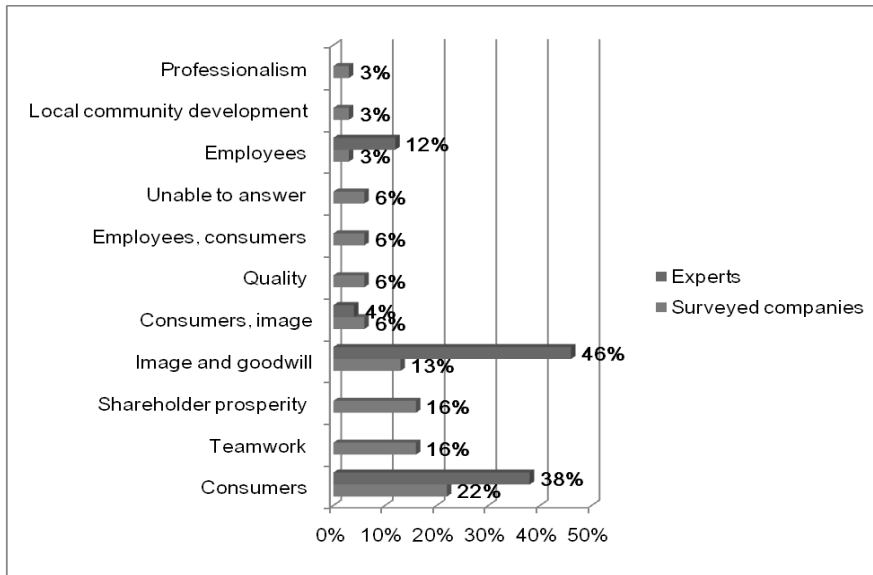

The introduction of the Code of Ethics and its actual implementation in practice are the assessment criterion and “visit card” both for the company and its every employee. The survey results demonstrate that 66% of the surveyed companies have Code of Ethics and emphasize its importance as an element of corporate culture, since they orient the employees towards corporate goals, contribute to identifying the corporate values and rules, as well as influences on the formation of interested people’s insight about the company and on reinforcement of its reputation. At the same time, 25% of the surveyed companies has mentioned about the absence of the Code of Ethics, commenting that their development and implementation is a necessary but prospective issue.

Taking into consideration the functional significance of Code of Ethics (reputation, management, corporate culture development), the accessibility principle of corporate culture, as well as the fact that the value system formation function includes the functions of the preservation and transfer of these values, than awareness of stakeholders about this fact becomes important. From the survey results it becomes clear that 53% of the companies inform the stakeholders about rules of conduct. Rather high is the percentage of companies (31%) that didn’t answer or had difficulties to answer to the given question. Therefore, we may conclude that the companies that have Code of Ethics do not still lead a consistent policy for the revelation and provision of their transparency,

which receives special significance from the aspect of diffusion of the best practice as well as transmission of the value system of the companies to the society.

Intention as a function of corporate culture

The Code of Ethics orients the employees to the corporate goals, supports the identification of corporate values and rules. Any company has certain goals that make its activities meaningful. Therefore it is expedient to view the corporate goals of the surveyed companies, dividing them into economic and social.

From the analyses of Table 1 it follows in the surveyed companies the prevalent economic aim is the growth of profits both as a separate group as well as in comparison with other goals. At the same time the 53% of the surveyed companies have indicated as economic goals the following: "Increase of profits, high quality, position strengthening and achievement of new sectors in the market".

Concerning the results of expert survey, the attention of Armenian companies is concentrated on the growth of profits, which is expressed both in separate groups and in comparison with other goals (Table 1).

Table 1.

Economic goals of the Armenian companies

<i>Economic goals</i>	<i>Companies, %</i>	<i>Experts, %</i>
Increase of profits, high quality, position strengthening and achievement of new sectors in the market	53	11
Increase of profits	14	58
High quality, achievement of new sectors in the market	12	8
Increase of profits, high quality, position strengthening	9	19
High quality	6	-
Position strengthening	3	4
High quality, position strengthening	3	-

In the social goals of the surveyed companies the personal growth and material welfare of employees relatively prevail. 41% of the surveyed companies have specified in their social goals the personal growth and material welfare of the employees as well as the favorable atmosphere and the involvement of young specialists, i.e. the main priority is given to internal social problems. As a result, only 6% of the surveyed companies considers the participation in the solution of communities' social problems as a social goal. It is necessary to add that in the 65% of the surveyed companies the social goals are totally absent.

The experts also confirm that social goals of the Armenian companies have internal orientation, but more than 19% of the experts mention that the companies involve the community development in their social goals.

As a matter of fact, the basic aim of the companies' activities in Armenia is the profit, and where the companies have also social goals, those primarily are of internal orientation. Such situation can be explained by the private sector life duration in Armenia. At their "young" age the Armenian companies encounter the problem of survival, so they set the deriving of profit as their supreme goal, at best they limit themselves by the solution of internal problems, isolating from social issues of community significance.

Formation of symbolic elements as a function of corporate culture

Corporate values of the companies find their reflection not only in their rules of conduct and goals, but also in their slogans, symbols, stories and legends, i.e. in the elements that form the "symbolic" level of displaying the corporate values.

Survey results show that 80% of the companies have slogans, the publicity of which is provided. The companies also have firm symbols (logotypes, firm calendars, stationery and so on), approximately 60% of the surveyed companies create legends or stories which mostly relate to their foundation as well as to their first leaders, founders and reputable employees.

Certain progress can be recorded in the practice of formation of the companies' corporate culture "symbolic" elements, which, when compared with the level of established corporate values, allows to conclude that in the surveyed companies the level of established corporate culture oscillates between the stages of "foundation"- "childhood" (Shein E., 2001). This means that in some companies we can see the spirit of collectivization, but there is no distinctly formulated value system in place, in the second part of companies the elements of corporate culture are in the stage of formation, while others already have their individual firm style. The foregoing is supported by Figure 2, from which it follows that the companies primarily treat themselves as partnerships, which is mostly

characteristic to initial stages of the corporate culture life, when the manifestation of creative approaches, teamwork ability, and combination of independence, collective thinking and activities are far more encouraged.

Figure 2. Description of the surveyed companies

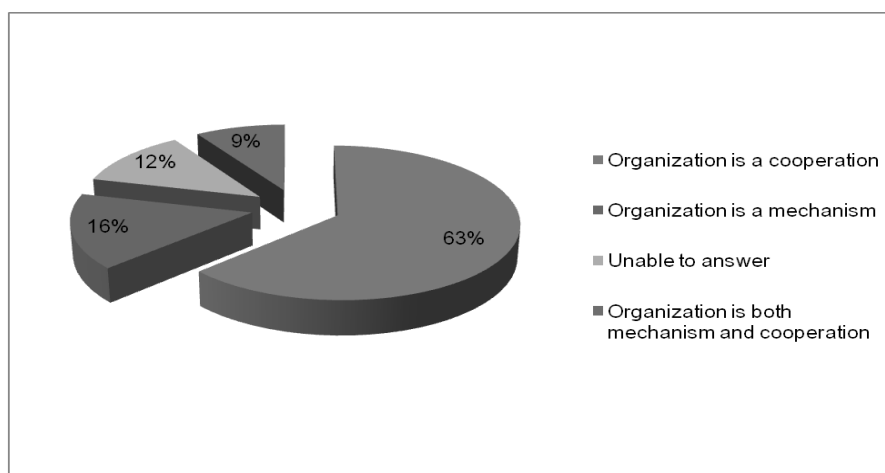

The fact that Armenian companies are in the stage of corporate culture “foundation”-“childhood”- “adolescence” is supported by the surveyed companies’ responses who state that the senior management is basically responsible for the corporate culture formation. Taking into consideration the CG peculiarities in Armenia, when the owners are mainly involved in the company’s day-to-day management, the decisive factor influencing on the formation of the companies’ corporate culture can be considered the personality of the owner. It can be stated that the experts share this opinion with the surveyed companies. This means that in Armenian companies the peculiarities of corporate culture are conditioned by the ideas, approaches, dispositions and value system of the owners.

Ensuring communication as a function of corporate culture

As a living organism any company needs coordinated activities of its internal units, subdivisions as well as of the employees. Corporate culture is a mechanism that incorporates different units of the company in one entirety through regulation of information flows. In the 34% of the surveyed companies the main source of information are immediate managers, at the same time there exist such sources of information as internal electronic communication (16%), publication of internal newspapers

(3%), combination of the mentioned sources of information (Figure 3). 46% of experts state that the source of information are immediate line managers, whereas 38% mention that employees are being informed through gossips (Figure 3), i.e. according to the experts, the communication system in the companies is not efficient enough and does not provide symmetric distribution of information, giving rise to gossips which, in their turn, may cause circulation of unreliable information.

Figure 3. Main channels of information dissemination of the Armenian companies

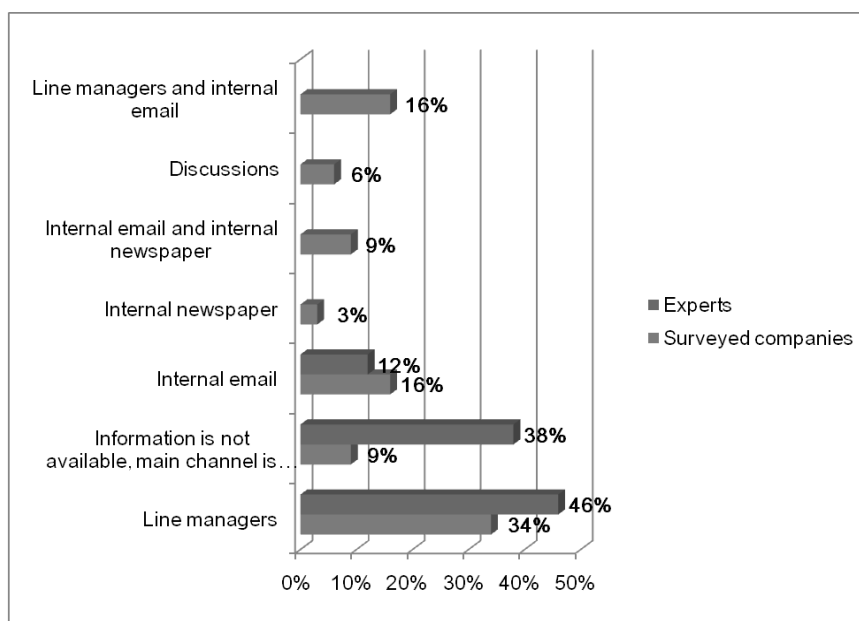

Taking into consideration that in Armenian companies the main source of information is the immediate manager, special importance is given to the nature of manager-employee relations. 87.5% of the surveyed companies have responded that the managers always communicate with employees, whereas the results of the expert survey demonstrate a very strict characterization of manager-employee relations, according to which more than 46% of the experts have mentioned that manager-employee relations are practically absent (Table 2). The difference in the answers of surveyed companies and experts can be explained by the fact that qualitative features of the surveyed companies' corporate culture are different as compared with those applied in other enterprises. Besides, in the surveyed companies the inquiry was conducted with the managing personnel. Therefore, certain bias in the answers is not excluded.

Table 2.

Relations between managers and subordinates inside the Armenian companies

Relations between managers and subordinates	Experts, %
No relation in practice	46
Managers regularly interact with subordinates	27
Formal relations are preferred than interpersonal relations	15
Unable to answer	6
Relations depend on the situation	4

In terms of corporate culture formation, communication of rules, feedback and provision of internal integration, the as well as horizontal regulation of information flows becomes more important.

As a tool of information flows bottom-up regulation can be considered the inquiries conducted among employees (as a model of referendum implemented in democratic countries), the participation of employees in the company management or the discussions held with the employers, which can be characterized as effective mechanisms for foundation and reinforcement of democratic elements within the companies. Only 47% of the surveyed companies have certain experience in conducting inquiries among employers, whereas in 41% no inquiries have ever been held. Prevailing majority of the experts have mentioned that no inquiries are being conducted among company employees. As to the employee participation in the management process, a more detailed discussion will be provided in the study of corporate culture socialization function.

The nature of relations among employees becomes important from the perspective of horizontal regulation of information flows, since company employees are not only the carriers of corporate culture elements but also those who communicate such values.

Figure 4. Essence of the employee relations of the Armenian companies

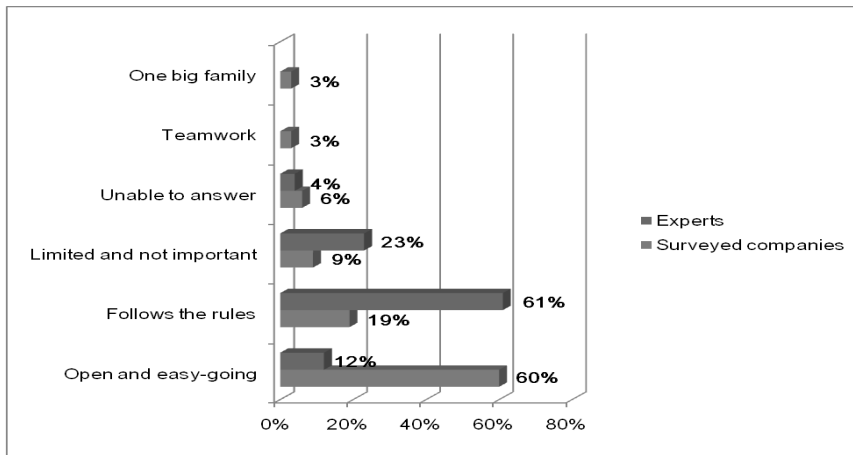

Relations among employees of the surveyed companies are mainly open and easy-going (Figure 4). However, according to the experts, these relations generally adhere to certain rules (Figure 4). Therefore we may conclude, that in both cases no serious obstacles for ensuring horizontal information flows are observed. Concerning the vertical (top-down and bottom-up) links of communication, here we observe obvious problems, which are expressed in the limited nature of manager-employee communication and feedback.

Formation of educational system as a function of corporate culture

Corporate culture encourages the training, education, raise of qualification, self-education and self-development, promotes the increase of such competency components as the professional characteristics of employees, creative potential.

Almost 35% of the experts have mentioned that in Armenian companies nothing is undertaken towards the development of work potential and the increase of employees' competency components, and the most widely implemented measures, as per the experts, are the participation of employees in conferences and seminars (23%), as well as the raise of qualification at the company's expenses (27%).

As regards the surveyed companies, the increase of their employees' competency level is effected through internal trainings and participation in qualification improvement programs financed by the company (41%). It should be noted that more than 9% of even socially responsible companies do not take any steps in this direction (Table 3).

Table 3.

Staff development programs implemented by surveyed companies

Staff development programs	Surveyed companies, %
Internal trainings, qualification improvement	41
Qualification improvement by the company	10
Internal trainings	9
Nothing is done for this sphere	9
Conferences, seminars	6
Internal trainings, conferences, qualification improvement	6
Unable to answer	6
Consultants' involvement	4
Qualification improvement by the employee	3
Self-development	3
Conferences, self-development	3

The nature of measures targeted at the development of human potential in the companies is an essential issue. Both experts and companies share the opinion that more active employees usually appear in the role of their initiators. Such measures are of non-regular nature, and their implementation is basically conditioned by the need to address situational problems.

Socialization as a function of corporate culture

The socialization function is reflected in the company management process through participation of employees.

To characterize the participation of employees in the company management process it is worthy to distinguish two levels of management: general management, which is realized through the involvement in the companies' board of directors, and current management, which is carried out through assistance to the executive body's activities.

Taking into consideration the Armenian model of CG and the fact that the surveyed companies are CJSC-s and LLC-s by organizational-legal status, for which the formation of the board in the management structure is not a mandatory requirement, the employees of such companies mostly do not participate in the general management. Their participation mainly concerns the current management.

It is worthy to refer to the companies' management style through which the level of employee involvement in the management process can be revealed. Thus, in 50% of companies the identification of prevalent activity directions and goals, basic methods and ways of their implementation, as well as the determination of control system is effected through the collaboration with employees (Figure 5). The experts give rather strict assessment to the management style: 42% believes that the management brings to realization of strict control without determination of prevalent activity directions and goals, basic methods and ways of their implementation, and 38% thinks that the identification of prevalent activity directions and goals, basic methods and ways of their implementation, as well as the determination of control system is effected without employee participation (Figure 5). Thus, by the management style feature, the corporate culture of surveyed companies more closely resembles the clan model (Cameron K. and Quinn R., 2001), and according to the experts, in Armenian companies there are no classic models of corporate culture in place.

Figure 5. Management style of the Armenian companies

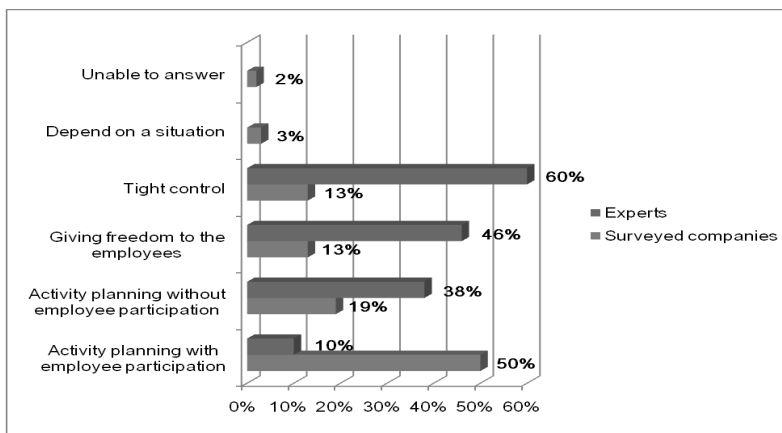

Both experts and surveyed companies have mentioned that periodic discussions with participation of employees are organized. The main

subject of discussions are issues of production nature, as well as working conditions, remuneration, assessment results, social conditions.

Encouragement of employees as a function of corporate culture

Corporate culture is a significant mechanism that impacts the motivation of employees through incentive system. A necessary condition for application of one or another encouragement option or mode is the assessment of the employees.

Survey results show that in 50% of companies the employee assessment system is absent, and in 50% it is present. In consideration of the latter, 41% of the companies had difficulties in answering the question by whom and how the assessment of employees is realized. At the same time, an identical number of companies has reported that the assessment of employees is effected according to the criteria defined by the company, by immediate managers and through open method. Thus, the companies ensure the transparency of both the criteria and method of assessment, which is laudable for the formation of appropriate behavioral model in the given companies, as well as in terms of ruling out undesirable and prohibited actions.

As opposed to the companies, the experts have indicated that in the large majority of the companies the assessment of employees is conducted by their immediate managers using individual approaches, and if 15% apply the open method of assessment, in 69% the secret mode prevails. This means that according to the experts, the assessment system existing in Armenian companies can lead to application of subjective approaches and creation of conflicts, which might be threatening for the corporate culture, especially for the realization of encouragement function.

As follows from Table 4, among employee encouragement modes the material motivation tools, such as remuneration for performed work, bonuses, participation in the profits. At the same time, it is necessary to note that material incentives of encouragement are the hygiene factors of motivation (Graham H., Bennett R., 2003), the significance of which in the satisfaction from work either decreases over time or is not essential from the beginning.

Table 4.

Employee encouragement modes of the surveyed companies

Encouragement modes	Surveyed companies, %
Material motivation tools	25
Material motivation tools, additional privileges, status, social motivation, personal motivation	22
Material motivation tools, status, social motivation	16
Material motivation tools, social motivation	9
No motivation tools	9
Material motivation tools, status, social motivation, personal motivation	6
Material motivation tools, additional privileges, social motivation	6
Status	3
Unable to answer	3

The role of companies in environmental and anti-corruption issues

The companies have special role in the formation and addressing of environmental risks and challenges: on the one hand they appear as a problem formation source, on the other hand – as the major player in their solution.

The survey results have revealed that only 25% of the companies have environmental protection policy: 37.5% of the surveyed companies have practice in implementation of environmental measures, and 62.5% had difficulties to specify any environmental measure realized by their company. As a result we can state, that the environmental management system is mainly absent in Armenian companies, and measures realized by the companies in this sphere are mainly conditioned by certain time periods or are forced by circumstances.

Both the surveyed companies and the experts mostly view the corruption as a social malice. As a principal anti-corruption mechanism, as seen by the surveyed companies (57%), may be the provision of legal compliance. At the same time, only 3% of the companies give importance to conducting explanatory works among employees as a means of combating corruption. It is important to note that 9% of the companies not only does not condemn corruption facts, but, on the contrary, tries to encourage the corruption, motivating that no successful business will be possible without bribes and other corruption facts. Besides, if we combine the responses “No measures are implemented”, “Have difficulties to answer”, “Do not see any ways of struggle”, we can state that 24% of the surveyed companies have rather passive position regarding the problem (Table 5).

Table 5.

Main tools to combat corruption in the surveyed companies

Main tools to combat corruption	Surveyed companies, %
Provision of legal compliance	57
No measures implemented	9
Have difficulties to answer	9
Corruption encouragement	9
Development of own plan of combating corruption	6
Do not see any ways of struggle	6
Trainings for employees	4

As to the experts, overwhelming majority of Armenian companies has rather passive position regarding this problem.

Perception of corporate culture and its link with economic democracy by the surveyed companies and experts

Responses provided both by experts and companies suggest that the concept of “corporate culture” is perceived by them according to its elements. Besides, the survey results demonstrate that companies attach importance to the relationship between the corporate culture and efficient company activities, and the advantage of formation of favorable moral and psychological climate among the staff.

Concerning the relationship between corporate culture and economic democracy, 46% of the experts describe it as a direct link, 38% see the existence of such link in a long-term perspective; 38% of the companies describe it as a direct link, and 59% see the existence of such link in a long-term perspective.

Conclusions and Recommendations

The major conclusion deriving from this research is that the Armenian market participants perceive the existence of relationship between corporate culture and economic democracy, however for most of them it is visible in the long-term perspective, which can be explained by revealed peculiarities of the Armenian corporate culture. According to these peculiarities, even socially responsible companies and those having active position in the market have certain problems in the process of corporate culture formation, development and communication. Without excluding the active role of the private sector in the establishment of economic and political democracy, nevertheless we can state that the perception of fundamental democratic values by the society, i.e. the degree to which the democracy is established in Armenia, is no less important, since the relationship under consideration is two-sided. The formation of effective corporate culture systems by the private sector can be considered as the driving force, leverage or creative potential able to change the existing public understandings, since responsible activities of the companies result in the formation of the social capital of trust and fairness.

Based on the outcomes of this research, with an aim of corporate culture development, as well as implementation and reinforcement of economic democracy principles, the companies are recommended:

- To develop the corporate management practice and the conduct of business based on behavioral principles. To view the corporate management, corporate social responsibility and corporate culture in one entirety, as mechanism that supplement and develop each

other, which are based on the principles of integrity, fairness, responsibility, transparency and self-regulation.

- To form responsible business conduct, this assumes the existence of a value system that is not limited to the supreme goal of deriving profit. The value system of the company should enable to correctly assess the nature of decisions made by the company, its actions and their realization techniques. of the companies. Besides, it is necessary for these values to turn into a part of business culture and practice.
- To know own corporate culture, its peculiarities, try to manage their corporate culture realizing the advantages it has upon existence of reliable relations with internal and external stakeholders, and perceive that without trust each will play his own “game”, which has no relevance to the general rules of the game, and at worst contradicts them.
- Collaborating with other business structures, government bodies and institutions of civil society, foster the formation of market institutions and mechanisms, the solution of problems having priority importance for the society development, as well as the communication of civilized practice and the increase of competency of interacting persons.
- To form effective systems of assessment and encouragement, communication and even distribution of information, this will contribute to the efficiency increase and creation of healthy moral and psychological atmosphere in the companies.

At the same time, the role of state and civil society institutions in activation of the social role of business and the strengthening of economic democracy through it may not be underestimated. The activities of state bodies should also be based on the principles of social responsibility and fairness, and the assessment methodology of their activities should be based on consumption approach, i.e. the assessment of the level of satisfaction of state services consumers, i.e. businesses and the society, with those services and their providers. At the same time, the state should take care of the introduction and implementation of fundamental corporate culture principles inside the state bodies and structures.

As regards the civil society institutions, not only they should be involved but also actively participate in the solution of basic social issues through the study of the society needs, formation, presentation and realization of the society order, as well as the increase of public awareness.

Only due to three-sided collaboration the realization of issues faced by each party and the establishment of democracy in the country will be possible.

References

- Cameron, K. and Quinn, R. (2001). *Diagnosing and Changing Organizational Culture*. Piter. Retrieved from: <http://dd.universtal.ru/domdoc/All+Documents>.
- Cyert, R. and March J. (1959).
- Deal, T. and Kennedy, A. (1982). *Corporate Cultures and Corporate Life*.
- Dubinín, Ľ.Á. (2002). *Corporate Ethics as a Tools of Social Management*.
- Eldridge, J., Crombie, A. (1974). *Sociology of Organization*. London: Allen&Unwin.
- Erasov, B. (2000). *Social Culture*. M.: Aspekt-Press.
- Gold K. (1982). *Managing for Success: A Comparison of the Private and Public Sectors*. Public Administration Review.
- Graham, H., Bennett, R. (2003). *Human Resources Management*. Translation of English under editing T. Bazarov and B. Eremin. M. Juniti-Dana.
- Hall R. (2001). *Organizations: Structures, Processes, and Outcomes*.
- Hampton, David R. (1987). *Organizational behavior and the practice of management*. Copyright Harper Collins Publishers Inc.
- Maslennikov R. (2007). *Philosophy of Corporate Culture*, Moscow, Delo.
- Michon C., Stern P. (1985). *La dynamisation sociale*. P.:Ed. d'organisation.
- Peters T.J. (1982). *Waterman R.H. In search of excellence governance*. N.Y.:Harper and Row,.
- Sathe V. (1985). *Culture and related corporate realities*. - Richard D. Irvin, Inc.
- Shein E. (2001). *Organizational Culture and Leadership*. Piter. Retrieved from <http://dd.universtal.ru/domdoc/SYONMXHMG.nsf/All+Documents>.

გამყიდველის სოციალური გავლენის პრინციპები ყიდვის პროცესში

*ციცქიშვილი რუსუდანი
საქართველოს უნივერსიტეტი*

სოციალურ ზეგავლენას მნიშვნელოვანი ადგილი უჭირავს სხვადასხვა სფეროში და მათ შორის არის სამომხმარებლო ქცევა. სამომხმარებლო ქცევის ერთ-ერთი შემადგენელია უშუალოდ ყიდვის განხორციელების პროცესი. ამ დროს მომხმარებელზე მრავალი ფაქტორი მოქმედებს. ერთ-ერთი ძირითადი ფაქტორი არის გამყიდველი. გამყიდველი იყენებს სხვადასხვა ფაქტორს მომხმარებელზე ზეგავლენის მოსახდენად. ამისათვის ის უპირველეს ყოვლისა უნდა იყოს აღქმული მომხმარებლის მიერ როგორც მიმზიდველი და სანდო. გარდა ამისა, გამყიდველი ზეგავლენის მოსახდენად იყენებს მთელ რიგ ტექნიკებს. მათ შორის ძირითადია: სხვა მომხმარებელთა ქცევის დამოწმება, პროდუქტის შეზღუდული რაოდენობით წარმოდგენა, თანამიმდევრული დათანხმება, დავალებულობის გრძნობის გამოწვევა, კონტრასტული აღქმა. ამ პრინციპების ცოდნა და მათი კრეატიულად გამოყენების უნარი არის აუცილებელი პირობა თანამედროვე კონკურენტულ სამყაროში გადარჩენად.

The Salesperson's Social Influence Principles in the Process of Buying

*Tsitskishvili Rusudan
The University of Georgia*

We live in the world of social influences: The number of our social relations rapidly increases and each of them contains the social influence in certain degree – people try to influence each other one or another. This is the case almost in all domains of social life. The targets of influence are

children and parents, friends and spouses, colleges, relatives, neighbors, voters, and, of course, consumers.

The modern human is permanently involved in relations of consumption. He/she systematically buys a big amount of products and services. At the same time he/she often plays the role of a seller. Most of us are "salespersons:" Marketers, lowers, doctors, teachers, psychologists, designers, artists, journalists and so on. We all sell our services. Nowadays a large number of people works in a wide range of services and sells goods, entertainments, work in the field of education and health care systems and so on. Consequently, for these people, professional success is determined not only by expertise in an appropriate area, but also by the art of relationship with a consumer, particularly, the skills of a consumer persuasion. These skills are partially innate and partially based on experience, observation, learning, and training. For the survival in the competitive market environment, the salespeople have to possess certain knowledge and skills to influence a consumer. They have to know the main principles of client persuasion and to be creative in usage of these principles.

One of the most influential principle is liking. No matter what is the reason for liking of the influence source. If we like it, we tend to be more persuaded by it. This truth is known by the professional salespeople very well and they use it in their practice. There are numerous ways to be more liked by a customer. We can categorize them into four main types of reasons. These types are: physical attractiveness, similarity, familiarity and compliments.

We like physically attractive people. It is more likelihood that customer appeals to good-looking salesperson, listens him/her and will be persuaded by him/her. Physically attractive people are more liked because they are rewarded: we get pleasure, experience positive emotions and moods, we feel ourselves calm and comfortable in relationships with them. Another reason is the stereotype that physically attractive persons have other good qualities as well, even such qualities that seem irrelevant to physical beauty, such as intelligence, expertise, kindness, honesty, truthfulness and credibility. It is clear, that the customer would be influenced by such kind of person much more then by other one. The third explanation for the salesperson beauty effect is the association aroused between salesperson and product or service offered by him/her. When one object becomes associated by another one, the positive perception of the first one tends to spread on the second one. That is in the case of the positive perception of the seller the customer tends to perceive more positively his/her product or service. Consequently, to take care about physical appearance for service workers is the part of their professional activity. This would be also taken into account by their supervisors in the process of selection and placement of their employees.

Liking is determined by similarity as well. Generally we like people similar to us and don't like dissimilar ones. The explanation for the similarity-liking connection is that similar people tend to agree with our ideas, values and interests and support our confidence in the rightness of our views. They understand us and we understand them. So interaction with them become more effective and rewarded. Another explanation for such similarity effect on attraction is the human tendency to maintain consistency among attitudes, to organize likes and dislikes in a balanced, consistent way. To perceive similarity with another person and at the same time dislike him/her is psychologically uncomfortable. We maintain cognitive consistency by liking similar persons and disliking dissimilar ones. The customer tends to like similar salesperson. Nowadays this truth is taken more into consideration in service. One example of this fact is that the models and TV journalists become plumper. The question is "is it possible for salesperson to be similar to all customers?" The answer is "yes": one thing is that the effect of similarity works even in the case of small similarities, when it refers to not very important personal qualities. Another thing is that no matter what the objective reality is, the salesperson may just seem to be similar to the customer. The goal is to attain the customer's "discovery" of similarity with the salesperson and this one helps customer in such a "discovery". The customer become more open for influence after hearing that salesperson has similar background or interests, place of origin, like same football team or actress and so on. Such kinds of relationships are more possible in the case of so called "commercial friendships", when salespeople and customers form warm, friendly personal relationships, containing something like affection, intimacy, social support and loyalty.

Commercial friendship has positive effects for marketers also because of another reason: in the one hand, a salesperson becomes more familiar for a consumer and in another hand, familiarity increases attraction. We like more familiar people, more familiarity cause more attraction. The positive effect of frequent contact and familiarity on liking is universal quality for human beings – we like much more everything that is usual and familiar because this make us free from uncertainty and anxiety, the situation become more predictable, we experience less tension and stress and spend less psychical energy. But of cause, it is a salesperson or any other object, if the initial impression is clearly negative, no following interaction would have positive effect. Positive effect of familiarity is the powerful reason for the success of the network marketing and "home shopping parties" – people listen more carefully arguments of familiar person and tend more to be persuaded by them.

Liking is determined by compliments as well. Many salespersons posses great skills of expressing their sympathy for costumers. They know how to say "I like you" to customers and as a result last ones have

no weapon against their offerings. The compliment may refer to the numerous kinds of things and these things may be quite unimportant ones as well. Even more a compliment works even when target knows that it is only tool in the hands of the source. The compliment may be nonverbal, when a salesperson expresses his/her positive attitude toward customer without words – by smile, eye contact, voice. The good salesperson always, even being in a bad mood, has to be able to smile warmly and tell to client, that he/she has wonderful taste, beautiful face, ideal weight, modern appearance and so on.

Besides liking another powerful influence principle is the salesperson's credibility. The source credibility is determined by two variables – expertise and sincerity. An expertise means authority, competence, knowledge and experience in given domain. We tend to believe in experts and their arguments, especially when lacking adequate information. The salesperson has to create impression of being an expert, show his experience and knowledge for having the chance to influence a customer. At the same time he/she has persuade the client in his/her sincerity. It is not easy to get the trust of client. But it is possible and salespeople achieve it in different ways. For example, a salesperson may “inform” customer about bad quality or defect of product and by such a way gain his/her trust. A credible salesperson is especially influential when a consumer has not yet learned much about a product or service and has not formed the opinion about it.

So, attractiveness and credibility are two especially important characteristics for effective salespeople. But they have to use also different techniques to persuade the consumer. Main kinds of these techniques are: principles of social proof, scarcity, reciprocity, consistency and contrast perception.

The principle of social proof means, that we tend to engage in certain behavior if we perceive that other people have done it. When we see that other consumer is interested in particular good, we nearly automatically turn our attention on this object. The effect of social proof is especially strong when the customer experience uncertainty and has no guidelines for decision making. In such case another customer's behavior becomes the guideline. Two conditions strengthen social proof effect: the consumer's similarity with the imitation object and amount of such objects. More perceived similarity cause more imitation. The consumer identifies his/herself with another one and uses following logic: he is alike me, he behaves in such a way that is I have to behave in such a way. No matter if there is or is not real similarity. Only customer's subjective perception is important. It is possible to use false customers to influence the real customer and salespeople do it sometimes, but usually they use another approach: they inform customers about “other customer's choice”. The specific case of social proof is when the customer identify

him/herself with any celebrity (doesn't matter why) and purchase certain goods or service only because this celebrity has done it. For example, the salesperson may tell young guy that he is alike to Brad Pitt and Brad Pitt had just such kind of glasses on Kann Festival.

Particularly strong type of social proof is conformity – the influence of majority. We have clear-cut tendency to see an action as more appropriate when majority are doing it. We often think that if a lot of people are doing something, it is the right thing to do. We look at others, gather information about others and take that into consideration in our evaluations and decisions. Because of such human quality salespeople often inform customers that his/her targeted object is favorable thing of most buyers. This message may be transmitted through different ways. For example, the salesperson may use such kind of words: “ Oh, you also like this sofa, it is so surprising, almost everybody likes it” or “ these cookies are selling very rapidly, I have to say them to get more”, or may be such kind of thing: “I can't understand why young people prefer these shoes” and so on. The salespeople's creativity is boundless, especially when they receive good commissions.

Salespeople often use the approach based on the powerful principle of scarcity – people's tendency to perceive opportunities as more valuable to them when their availability is limited. In fact scarcity is perceived as an object's value. We are afraid of losing and the potential loss plays a large role in our decision. Salespeople use scarcity principle in numerous ways. Of course, sometimes the limited-number information is true, but sometimes and quite often, it is wholly false. The object may become desirable only because it is less likelihood to get it. Even more - the consumer may be aware of the major reason for the object attractiveness (it's scarcity), but still has strong desire to gain it. The powerful reason for this is that uncontrollable emotions are involved. At this time it would be useful to ask ourselves: “why do I wish this thing: for using (in anyway) or just for possessing”, the sincere answer may save the huge amount of money that don't correspond to the real value of the object. Such in correspondence often is the case in the auctions. The scarcity principle power comes from two major sources. First is our tendency for spending less psychological energy, to think less: we know that the things that are difficult to possess are usually better than those that are easy to possess and we quickly make conclusion about targeted object, without thinking a lot. We are quite tired from processing external stimuli. The second explanation for scarcity effect is that as opportunities become less available, we lose freedom. But freedom is one of the most important value and we begin to make our best not to lose the freedom we already have – freedom of choice, freedom of possessing. As a result we spend money, sometimes very much money and our freedom become really expensive luxury.

Salespeople use scarcity principle in numerous ways. For example, salesman sees the customer looking at the product and thinking, evaluating it, searching arguments in his mind. At this moment the salesman comes to him and tells that this is really good thing, but unfortunately it is the last exemplar or the salesman may even tell to customer that the thing is already sold. In such a case the customer immediately decides that it is just the thing he needs. But that is not all: until he leaves the store, the salesman "discover" in his computer that they have such kind of things in the warehouse. The customer becomes happy and anxiously waits for the final "verdict". The another version of this play is "we don't have, but I can ask our branch shop". One more example of the scarcity principle usage is when false customer expresses the desire to buy the same thing as real customer thinks to buy or when some customers are invited for purchasing at the same time. When the customer sees the competitive other one the targeted object immediately becomes more valuable. Other powerful thing based on scarcity principle is an announcement that there are only limited-numbers of tickets, vacancies, flats or any other resources. The service workers use not only the number scarcity effect, but the time scarcity effect as well. That is the case when the salespeople tell to consumers that they may get the service only during the limited amount of time or that there is certain deadline for service usage. For example, they say that the concerts will be only until end of month. In such a case you would be in a hurry and may be visit the concert that you would not visit in other case.

The professional salesperson knows human beings' nature. He/she knows that human usually tends to be consistent and we see this tendency in many activities and in the consumer behavior among them. Particularly, if the person has told or done something, in the future he/she will try to act in such a way that don't contradict the thing he/she has said or done. This tendency is explained by the fact that human wants to be liked by others and inconsistency is an undesirable personality trait, the person whose words or behaviors don't match usually is evaluated negatively by others. Another explanation for the consistency tendency is that people are often afraid of new things, their unexpected results and chooses old ways. This is one of the reasons for the success of the brand extensions. So, if the customer bought our product, we will more expect that in the future he/she will buy the same thing, of course, if his/her expectations wouldn't be failed. Professional salesperson uses human tendency for consistency more subtly as well: the salesperson tries to get the consumer to make a commitment. Once a stand is taken, there is a natural tendency to behave in the ways that are consistent with the stand. For example, if the salesman sees that the lady is carefully regarding the refrigerator, he may ask this lady "Are you interested in this refrigerator?" and then the salesperson makes another question: "Are you going to buy

this refrigerator?" After a short warm and "sincere" conversation the salesman makes the last question "Are you buying this refrigerator?" The likelihood of the refrigerator purchasing will increase and even more, maybe the lady will buy the thing she was not going to buy at all. In another option of this approach the salesperson asks the consumer to make something for him, something little and unimportant, for example to sign the text that he/she positively evaluate this shop, or the shop environment is very pleasant, or something like that. The salesperson may also ask to fill the short questionnaire, give some information and so on. It is difficult to say "no" on such little requests. But the truth is that such kind of little requests have the great latent power, because they make favorable background for future influence: after a consumer say "yes" referring to something, maybe something very unimportant, in the future the likelihood he/she would agree referring to the more important thing increases. This reality is determined by the fact that the customer's self-image has changed a little. He/she becomes considered him/herself as having more favorable attitudes towards the product or the salesperson because he/she had done certain thing for him/her: our self-image is impacted in certain degree by the perception of our behavior.

They often noticed that human beings are "social animals." That is we share social norms that make possible to live in a society. One of them is the norm of reciprocity – when anybody makes something for us, we tend to make something for him/her in return. It is simple but important tendency and salespeople use it in different ways. The salesperson makes something for customer and waits that customer's tendency to be influenced would increase and he/she is right. For this purpose salespeople use free samples or ask to taste the product. Professional salesperson also knows that after he/she spend certain amount of time for consumer explaining what the product qualities are and how do product types differ from each other, it would become more difficult to walk away and not to buy anything.

Another simple and often used technique is contrast-using technique when salesperson suggests to consumer at the beginning product with unrealistic price or with unacceptable quality and only then suggests the product he/she is really going to sell. The last one would be perceived much more favorable and becomes much more attractive after such "an introduction" and likelihood of buying increases a lot.

This survey involves most often used techniques the salespeople use to influence a consumer. Of course salespeople often engage in some of these techniques at the same time. For the success they need not only knowledge but creativity as well – every situation is different, every consumer is specific, although there are typical situations and typical consumers. Two more things are irreplaceable – innate skills and experience. But the knowledge and trainings help salespeople be more influential.

Summery

The social influence is important in different domains of life and consumer behavior is one of them. Consumer behavior involves the buying process. Among other factors operating during this process one of the most powerful is the salesperson's influence. For exerting influence the salesperson has to be perceived by the consumer as attractive and credible. Besides salespeople use numbers of specific techniques. The most powerful ones are: the proof of other consumer's behavior, scarcity of goods or services, reciprocation between a salesperson and a consumer, consistent persuasion and contrast perception. The knowledge of these principles and the skills for their creative usage are key factors for survival in the modern competitive world.

References

- Aronson, E. (1998). *Social Wildness*. [obšestvennoe životnoe]. Moscow. Aspect Press.
- Aronson, E., Pratkanis, E. (2003). *The Mechanisms of Persuasion*. [mexanizmi ubeždenija]. St. Peterburg. Prime-Eurosign.
- Baron, R.A., Brandscombe, N.R., Byrne, D. (2008). *Social Psychology*. New York, Pearson.
- Blackwell, R. D., Miniard P. W., Engel, J. F. (2006). *Consumer Behavior*. Canada, Thomson.
- Blythe, J. (2008). *Consumer Behavior*. Canada, Thomson.
- Chaldini, R. (2008). *Psychology of Influence*. [psixalogija vlijanija]. St. Peterburg, Peter.
- Gardner, G. (2008) *Art and Science of People Persuasion*. [iskustvo I nauka vlijanija na vzgljadi ljudej]. Moscow. Williams.
- Levin, R. (2007). *Mechanisms of Manipulation*. [mexanizmy manipuljacii]. Moscow. Dialect.
- Patterson, K., Greni, D., Maksfield, D., MacMillan, R., Switsler, E. (2008). *How Can One Persuade the Others*. [kak vlijat' na drugix]. Moscow. Williams.
- Piz, A. (2006). *The Art of communication in Net Marketing*. [iskustvo komunikacii v setevom marketinge]. Moscow, Exmo. Prentice Hall.
- Ross, L., Nisbett, R. (1999). *Human-being and Situation*. [čelovek I situacija]. Moscow, Aspect Press.
- Schiffman, L. G., Kanuk, L. L., Hansen, H. (2008). *Consumer Behavior: a European Outlook*. London,

- Solomon, M. R. (2008). *Consumer Behavior: Buying, Having, and Being*. New York, Pearson.
- Stass, D. (2003). *The Psychology of Consumer*. [psixologija patrebitelja]. St.Peterburg, Peter.
- Taylor, S. E., Peplau, L. A., Sears, D. O. (2006). *Social Psychology*. Pearson, New Jersey.
- Temporal, P., Trott, M. (2002). *Romance with Customer*. St.Peterburg, Peter.
- Zavadski, M. (2006). *The Art of Trade*. [masterstvo prodaži]. St. Peterburg, Peter.
- Zimbardo, F., Lyaishe, M. (2000) *Social Influence*. [social'noe vlijanie]. St.Peterburg, Peter.

სამეწარმეო რისკ-მენეჯმენტი საქართველოში

ავალიშვილი-დე ბური მარინა
საქართველოს უნივერსიტეტი

თანამედროვე პირობებში, ბიზნესებს უწევთ სწრაფად ცვლებად გარემოში მუშაობა. ბიზნეს რისკები თანდათან სულ უფრო კომპლექსური, დინამიკური და მრავალფეროვანი ხდება. სამეწარმეო რისკ-მენეჯმენტის დადებითი შედეგების გათვალისწინებით, განვითარებულ ქვეყნებში კომპანიებში აქტიურად იწერება რისკების მართვის სამსახურები და მიმდინარეობს სამეწარმეო რისკების მართვის პროცესის სრულყოფა. საქართველოში ამ მიმართულებით სავალალო მდგომარეობაა და რამდენიმე ფინანსური ორგანიზაციის გარდა სამეწარმეო რისკების კომპლექსურ მართვას კომპანიები პრაქტიკულად არ ახორციელებენ. ამას ბევრი მიზეზი აქვს, რომელთაგან ნაწილი გამომდინარეობს ქართული კომპანიების თავისებურებებიდან, ხოლო ნაწილი ბიზნეს გარემოს სპეციფიკიდან. წინამდებარე სტატიაში განხილულია სამეწარმეო რისკ-მენეჯმენტის ძირითადი თეორიული საწყისები; გაანალიზებულია ფაქტორები, რომლებიც ხელს უშლიან სამეწარმეო რისკ-მენეჯმენტის განვითარებას საქართველოში; წარმოდგენილია რეკომენდაციები ორი მიმართულებით: თუ რა შეიძლება გააკეთონ თავად კომპანიებმა, როგორ უნდა განავითარონ შესაბამისი სამსახური და თუ რა უნდა გაკეთდეს ხელისუფლების მხრიდან, სასწავლო დაწესებულებებისა და არასამთავრობო ორგანიზაციების მიერ.

ERM in Georgia

Marina Avalishvili-de Boer
The University of Georgia

Businesses nowadays operate in an entirely different environment than in the past 20 years. Business risks became more complex, diverse and dynamic. Implementing Enterprise Risk Management (ERM) in this environment is no longer a choice. In the current economic climate, companies must be ready to respond to risks at all levels of their development. Enterprise risk management is a relatively new science. There is confusion about the meaning of enterprise risk management in different organizations and countries. There is no commonly used explanation of enterprise risk management, or a classification of enterprise risks and management process steps. It has been very difficult for companies and scientists to agree on a common language for the topic. Nonetheless, it is clear that an integrated enterprise risk management approach has many advantages and benefits and therefore companies recognise ERM as a critical management issue.

There has been a significant increase of interest in Enterprise Risk Management and many companies are in need for comparative benchmark data on ERM. Many international consulting companies study ERM issues and provide consultations about ERM issues to companies as an integral part of their services.

Several global surveys were conducted in the recent years, the most interesting of which are the following: (1) Delloite (2008), Perspectives on ERM and Risk Intelligent Enterprise; (2) AON (2010), Enterprise Risk Management Survey. Our comparison of these surveys leads to the conclusion that important drivers of ERM development are often the same. The key reasons for ERM are in particular regulation, regulatory compliance and Rating agency/ financial institution requirements. Other drivers are unanticipated losses, best practice, improved performance and decision-making, CEO impetus, and external stakeholder pressure.

In Georgian companies, enterprise risk management is not developed because of a variety of external and internal factors. Studying Enterprise risk management is of crucial importance for businesses to increase companies' value for shareholders and the society. In the long term, a more active ERM planning in Georgia will have positive economic and social effects for a country in development.

Enterprise Risk Management Theory

The term “risk” has numerous explanations and it is important to separate it from uncertainty. Uncertainty is a lack of certainty that results from a lack of knowledge and the impossibility for measurement. *Risk is related to the potential change of the state (of any object including business) where some possible outcomes have an undesired effect or entail a significant loss.* Risk can be measured by using objective probabilities that are based on statistical and historical data and subjective probabilities that are based on persons’ experience, knowledge and expertise.

Risks are characterized by diversity. New risks emerge as a result of economic and technological development of the modern world. At the same time, very often the same risks are defined by different terms. Sometimes, it is extremely difficult to separate different types of risks from each other, as there is a close cause-effect relationship between them.

There are four major factors for the classification of enterprise risks: Scale, level of acceptance, economic content, and risk sources. We think that in terms of enterprise risk management, it is desirable to classify risks by their sources and we agree with the opinion that the two major sources of risks are the organization’s internal area and the business environment. Risk factors from internal sources include operational, financial, and technological risks. Risk factors from the business environment include economic, social, environmental, legal, political, and market characteristics. However, we deem it expedient to single out strategic risks as a separate risk group from micro risk factors.

Risk management was established as an independent science in the second half of the 20th century and each stage of its development was related to some great industrial disaster. Enterprise risk management is based on the traditional risk management concepts with one major difference, namely that enterprise risk management provides an integrated management tool of all enterprise risks.

Enterprise risk management is part of the organization’s management strategy that aims at reducing the risks. Management and monitoring of various risks is not carried out individually, but in a coordinated way. As a result, the company can gain a long-term competitive advantage. Enterprise risk management increases the company’s value for the owners of the company and generally for the public.

Risk management process consists of six stages: Environment and company analysis, risk identification, risk measurement and prioritization, risk evaluation, planning of the risk reduction, management and monitoring. Each of these stages is an individual process with its own

goals, inputs, outputs, controls, mechanisms and activities. Success on one stage is the basis for the next as the output of the previous stage serves as the input for the next stage. There is a variety of useful mechanisms and activities for each stage that are developed recently. We believe that the most optimal result is achieved by defining the fifth stage (which is also defined to be risk reaction, risk response planning, risk management, etc.) as the risk reduction planning stage, a during this stage a particular strategy is selected about how the company should reduce the risks .

There are six major strategies of risk reduction: Diversification, risk avoidance, loss control, risk transfer, risk reassign, and risk retention. For different types of risks, on certain strategy or a combination of these strategies is used.

ERM in Georgia and activities to support its development

Based on the results of the ERM survey held in Georgia, which was conducted in the frame of the doctoral program last year, we can conclude that enterprise risk management is not developed in Georgia's business companies even at the basic level. The most important factors for the absence of ERM in Georgia are the following: (1) Failure of the company owners to properly assess the goals and benefits of enterprise risk management; (2) lack of support from managers. In addition, we can mention the peculiarities of the management structure of the companies, particularly, the fact that, very often, the owners (shareholders) and directors of the companies are the same people. Other factors include the following: (3) Absence of urgency proceeding from market position and business environment conditions – lack of competition on the market; (4) due attention is not paid to risk management in a business plan while issuing loans by financial organizations; (5) absence of requirements in Georgia (except for certain sectors, such as banking) posed by the regulatory entities for corporate governance. As internal control and risk management are subsets of corporate governance, there is no regulation governing them.

It is of crucial importance for Georgian companies to develop an Enterprise Risk Management Office. This would not be an easy task; however, taking into consideration the available foreign experience on this subject and an understanding of the benefits an ERM Office can generate, the establishment of such an office is worth the expenses and efforts. In the following part of the article, we will try to define the major factors and processes that companies should take in consideration for the formation of the Enterprise Risk Management Office.

Georgian Companies - Formation and Functioning of Enterprise Risk Management Office

Companies have different attitudes towards risks. These attitudes can be summarized on the basis of their risk tolerance as risk-seekers, neutrals and risk-avoiders. Risk tolerance of the companies and their risk management process depends on the following characteristics: Interests of company owners and decision makers, peculiarities of corporate governance, system of compensation for decision makers, size and organizational structure of the company, company's culture (Damodaran, 2008, pp. 340-365).

Enterprise risk management is a difficult, painstaking and, frequently, very expensive process.

While developing the enterprise risk management program, we should answer the following questions:

1. What is the ERM program goal?
2. How should the risk management office look like and what particular place should it take in the company's organizational structure?
3. Which particular instruments are used for identification, risk measurement and prioritization, risk evaluation, risk reduction?

The ERM program goals may be the following: Development of optimal mechanisms for risk management, promotion of implementation of corporate strategies, growth of transparency and accountability, prevention of critical risks, giving due consideration to the risks in decision-making process, observance of the company values by the owners, revealing new opportunities, increase in operational efficiency, etc. Selection of the goal depends on the stage of the company's development and different factors.

The second question entails the determination of the participants in the risk management process, their duties and responsibilities. Generally, all employees of the company are program participants, though it is desirable that responsible persons are those holding particular positions. Corporate governance codes of various countries provide general principles of responsibilities for the participants of the risk management process.

The key participants of the EMR are the following: Board of Directors – BOD (audit committee, risk committee), Chief Executive Officer – CEO/ Executive director, Enterprise Risk Management Executive chief risk officer – CRO, chief financial officer – CFO, risk officers and internal audit officers, managers, heads of departments, project coordinators, and team leaders.

The BOD is responsible for determining the company's strategic and critical risks, supervising risk management process and preparing a report for the owners. The responsibilities for concrete issues can be dele-

gated to the audit and risk committees. The BOD should discuss existing and new risks at least once a year and especially in the process of strategic planning it should provide (1) compliance of ERM program with a strategic plan; (2) optimal compliance of risk management centralization and decentralization; (3) moderate regulation of risk management. A systemic approach towards risk management and close mutual relations with other services stipulates that the relations between all services should be strictly determined; it is also necessary to determine the rights and obligations in various management offices.

The risk management office should be strictly subordinate to the regulation in place and the possibility of its development should be envisaged as well. Therefore, it is essential to find a balance between regulation and the freedom of creative initiatives.

In a modern company the role of ERM, which envisages management and monitoring of various risks (both internal process and external environmental risks) which are coordinated not individually, but under a joint strategy, effectiveness is optimized when the top management carries out the coordination of risk management in the organization (executive director or his/her deputy), while each employee should consider risk management as a part of his/her job. The executive director is the most important representative of the managerial staff, since he/she coordinates the entire process of risk management, makes strategic and tactical decisions and provides duly delivery of reliable and comprehensive information to the Board.

The executive director can create the risk management office or delegate this function to the chief risk officer or the chief financial officer. An executive manager (the name of the position has no decisive importance), who has relevant business skills and can search risk-related information from various sources, should be instructed to develop and implement the enterprise risk management strategy.

The risk management office should be directly subordinated to the executive director. It is desirable that the risk management office is created in the following composition: Information-Analytical Department (risk identification; measurement and prioritization; risk assessment), Risk Reduction Planning Department, Risk Control and Monitoring Department, etc.

Risk officers perform various duties within the frame of the risk management office, while audit officers conduct monitoring of the implementation and efficiency of the ERM program.

As far as top managers, heads of departments, project coordinators and team leaders are concerned, they are responsible for managing the risks (risk identification, accountability, etc.) in accordance with the purposes of their positions.

It is essential to involve the heads of all departments in the process of development of the ERM program. It is important for the heads of all departments (other services existing in the company) to deliver information about risks (presentation of risk management program) and to provide their feedback.

Formation of risk management office requires studying of the company's organizational structure. It is urgent that ERM is included in the formal corporate governance framework. It is especially important that information about risks is integrated into the decision making process by the Board and involve ERM in the business continuity plan (risk management plan is a part of business continuity at a pre-crisis stage).

Obviously, it is impossible to involve all ordinary employees in the process of program development, but it is necessary to develop a mechanism through which an employee will be able to deliver information to the management for the identification of any risk. Frequently, some risks remain unknown to the managers and the employees should notify them about it. Such initiatives on the part of the employees should be encouraged that will give them further motivation to watch business processes and developments closely and to cooperate with the managers in case of identification of a particular risk, or careful consideration of the risk reduction strategy.

Moreover, it is expedient to involve all leading stakeholders, such as key providers, consumers, partners, financial institutions, in the process of EMR program development. Furthermore, at the stage of risk measurement, assessment and development strategy of risk reduction, it is urgent to involve independent experts, who will make impartial conclusions.

To increase the efficiency of risk management office, it is important:

- (1) To provide constant raising of qualification of the head and the employees;
- (2) To bring job characteristics in compliance with staff capabilities;
- (3) To constantly develop the principles of staff motivation;
- (4) Since the staff provides information delivery and processing, their studying and upgrading should take place on a regular basis.

The key basis for the success of the enterprise risk management office is human resources. The staff working for the office should necessarily have a relevant education that requires the existence of special retraining and certification programs, have a good knowledge of the stages of risk management process and their interconnection, be familiar with the methodology used for risk assessment and reduction, have sufficient knowledge about statistical analysis and probability concepts, maintain a balance between theoretical knowledge and practical experience, effectively direct working meetings, which are held at various stages of risk management process while using various methods and with the participation of all stakeholders or experts (for example, upon conducting

SWOT analysis, analyzing the scenarios, etc.), try to improve the used methods and introduce modern methods, create and update business register, use various methods of information delivery (such as strategic risk map, strategic goal tracking board, etc., and also standard documents), be able to determine and implement risk management policy and procedures.

The introduction of information-computer technologies (computer software) has a crucial importance for the development of a risk management office. Development of information technologies promotes the effective and quick solution of managerial decisions as well as processing of database (risk register).

Each stage of the ERM process – business and environmental analysis, risk identification, measurement and prioritization, risk assessment, risk reduction planning, risk management and monitoring – is necessarily accomplished by communication, through which information is exchanged at the internal organizational level and between the organization and the environment. Proper organization of communication is a cornerstone for risk management. During risk management, it is essential:

(1) To constantly provide risk management office with reliable information;

(2) To observe and periodically study external environment and behavior of competitor enterprises;

(3) To establish effective mechanisms of collection, updating and availability of relevant data related to risks;

(4) To observe all types of risks and yielded results and to create a uniform information base (risk register);

(5) To select simple and established parameters for measurement of strategic business goals, risk controls and risk drivers;

(6) To provide confidentiality of information.

Accuracy of any calculation depends on the selected model and proper implications, as well as a moderate use of historical data. It is desirable to use scenario analysis and historical simulation simultaneously. It is logical that while assessing the risks, quantitative methods give a more accurate assessment about the risks, though frequently this is impossible due to a lack of available data. It should also be noted that it is not always necessary to use quantitative methods for assessment; sometimes, identification of a critical risk is enough for the development of a risk reduction strategy. Therefore, it should be defined in which particular cases the risks should be measured either by quantitative or by qualitative methods.

As soon as the company identifies and assesses the risks, risk reduction planning should start. The risk reduction planning stage covers the following activities:

- (1) To determine, whether obtained information is enough and to conduct additional researches in case of necessity;
- (2) To develop several alternatives to each particular risk reduction strategy;
- (3) To assess the value of strategy implementation and to compare it with the amount of losses;
- (4) To elaborate a schedule during strategy implementation;
- (5) To define the risks and difficulties emerging in the process of strategy implementation;
- (6) To develop key risk indicators (KRIs) and early warning indicators (EWIs).

As mentioned before, there are several risk reduction strategies. A company selects its strategy depending on numerous factors of which the most important are: (1) Types of risks, with consideration to their probabilities and impact/losses, (2) expenses to be defrayed for the implementation of the strategy.

In the conditions of a transitional economy, such as in Georgia, companies and investors mostly use two methods of risk reduction: Risk retention (that is cold self-insurance and means creation of the „risk“ fund to cover losses) and insurance. Generally, the use of risk retention method is more effective when the size of the „risk“ fund is small, or when investing in various assets becomes less profitable. We can discuss the advantages of risk retention from economic and managerial points of view. Economic efficiency envisages saving of insurance premium and, respectively, reduction of expenses, as well as opportunities to receive revenues for the reserve fund, saving of money as a result of detailed observation of losses in the past, etc. From the managerial point of view, we can distinguish the growth of flexibility of risk management, maintenance of control on money assets, etc.

Insurance was and still remains the most widespread method of risk management throughout the world. In Georgia insurance is often the only strategy, which most companies use to reduce the risks (although only for a few risks). The insurance market in Georgia is its development stage; the types of basic enterprise risk insurance are provided by insurance companies, though there is actually no demand for some of them.

As far as the second issue is concerned – i.e. determining and considering the expenses necessary for the implementation of the risk management strategy – it can be argued that ERM should be cost effective. However, at the same time, there are frequent cases where companies agree to bear expenses for the creation and implementation of more expensive models and strategies because in this process they generate information to their own companies that eventually assists them in making strategic decisions (quality of decisions increase).

The final stage of risk management process is management and monitoring. Monitoring organized correctly provides granting of necessary independence to the employees, on the one hand, and avoiding of mistakes, on the other.

In order to promote the development of enterprise risk management in Georgian companies, it is essential that various stakeholders, such as the state, the financial sector, educational institutions, non-governmental organizations, and think tanks carry out relevant measures.

The Role of the State

State support is important and essential, especially in the conditions of a transitional/developing economy. In order to provide further development of enterprise risk management it is urgent:

1. *To promote the growth of competition.* Promotion of competition will provide the development of companies' management in the long term; the owners will pay more attention to risk assessment and management.

2. *To focus on the Free Trade Agreement with the European Union and to promote the compliance with the EU standards.*

3. *To improve the Law of Georgia on Entrepreneurs and other laws.* Legislation should promote business in the following directions: (a) improvement of the companies' management structure, (b) introduction of internationally recognized principles of corporate governance, (c) obligation of concluding written agreements between counteragents on particular business operations and elaboration of the rules of submitting necessary information for the agreements, (d) restriction of frequent changes to the Tax Code and business-related laws, (e) introduction and observance of necessary security norms that is especially important in construction and processing industry.

4. *Promotion of the necessity of ERM on the part of the Ministry of Economy and Sustainable Development of Georgia and other state agencies.* It is essential to demonstrate the importance of enterprise risk management to businesspeople. This can be achieved in the following ways: (a) existence of risk management system in the company and adequacy of risk management process can serve as one of the evaluation criteria while holding various business competitions, (b) require the existence of risk assessment and management mechanisms in the companies while holding various tenders on state procurements, especially when the work to be done and the commodities are expensive, (c) in the process of privatization, as well as in the process of submitting investment projects and carrying out talks with the investors, it is essential that the authorities focus on the urgency of risk management, (d) it is important to imple-

ment relevant projects to promote the development of corporate governance.

5. *Promotion of the development of financial markets.* In terms of risk management, it is especially important to develop insurance and securities markets in the country.

The Role of Educational Institutions, Non-Governmental Organizations and think tanks

To introduce enterprise risk management and the related specialties;

To create textbooks in the Georgian language; to create a dictionary (English-Georgian) on risk management terms;

To develop a course of trainings on risk management (similar courses exist in respect of the financial sector, though not for other sectors) for businesspeople and other interested persons;

To conduct researches in the sphere of risk assessment and management by economic sectors as well as to develop relevant recommendations;

To deliver information to the founders of the companies about the best practices of risk management; to discuss particular successful business cases with them; to draw their attention to the importance of risk assessment in business planning.

References

- Monaham, G. (2008). *Enterprise risk management: A methodology for achieving strategic objectives*. New Jersey: John Wiley & Sons, Inc.
- Chew, D.H. (2008). *Corporate risk management*. New York: Columbia University Press.
- Damodaran, A. (2008). *Strategic risk taking*. New Jersey: Pearson Education, Inc.
- Frame, J.D. (2003). *Management risk in organizations, a guide for managers*. San Francisco: Jossey-bass.
- Doherty, N. (2000). *Integrated risk management: techniques and strategies for managing corporate risks*. New York: McGraw-Hill.
- Aon. (2010). *Global enterprise risk management survey*. Amsterdam: Author.
- Moeller, R.R. (2007). *COSO enterprise risk management: Understanding the new integrated ERM framework*. New Jersey: John Wiley & Sons, Inc.
- DeLoach, J.W. (2000). *Enterprise-wide risk management, strategies for linking risk and opportunity*. Financial Times Prentice Hall.

- Delloite. (2008). *Perspectives on ERM and the risk intelligent enterprise. Enterprise risk management benchmark survey*. Retrieved September 12, 2010, from http://www.deloitte.com/assets/Dcom-UnitedStates/Local%20Assets/Documents/us_risk%20consulting-ERMBenchmarkSurvey_110308.pdf
- Dafikpaku, E. (2011). *The Strategic Implications of Enterprise Risk Management: A Framework*. 2011 ERM Symposium. Retrieved May 16, 2011, from <http://www.ermssymposium.org/2011/pdf/Dafikpaku.pdf>

Law**მინდობით აღზრდა და მისი გამიჯვნა
მომიჯნავე ინსტიტუტებისაგან**

*მასხარაშვილი ხატია
საქართველოს უნივერსიტეტი*

მინდობით აღზრდის მიზანია ბავშვი აღიზარდოს ოჯახურ გარემოში და ჩამოყალიბდეს სრულფასოვან მოქალაქედ. უზრუნველყოს ბავშვის საზოგადოებაში ინტეგრაცია, ეკონომიკური უთანასწორობის შემცირება, თავიდან გვაცილებს მზრუნველობამოკლებული მოზარდის კრიმინალური სამყაროს გავლენის სფეროში მოქცევის საფრთხეს, მოცემული კვლევის მიზანს წარმოადგენს ასევე მინდობით აღზრდის ინსტიტუტის და სხვა მსგავსი ინსტიტუტების შესწავლით ხელი შეუწყოს აღნიშნულ სფეროში კანონმდებლობის სრულყოფას, მომავალში ასეთი ბავშვების ინტერესების დაცვას და მათი ოჯახურ გარემოში აღზრდის სრულყოფას. ილია ჭავჭავაძე ბრძანებდა: „შვილის გაზრდა, შვილის კაცად გამოყვანა უწმინდესი და უდიდესი ვალია მშობლებისა... გაზრდა შვილისა ისეთი მოვალეობაა, რომ სხვა ყველაფერი ამას უნდა შეეწიროთ, ამას უნდა შევალიოთ, სხვაგან და სხვაში უნდა დავიკლოთ და ყოველივე ნაწლაგ-ნადაგი, ყოველივე ამაგი უფრო _ ერთი დრო ამას უნდა შევახმაროთ... ტანთ მოიკელო, ფეხთ მოიკელო, მშიერ-მწყურვალი იარე და ნუ ჩასდგები ჯერ შვილისა და მერე ქვეყნის ცოდვაში. აი, რა უნდა ეწეროს გულის ფიცარზე იმ წმინდა საქმეს, რომელსაც მამა-შვილობას ეძახიან“.⁵ ზევით ხსენებულიდან ნათლად არის ჩამოყალიბებული ის საკითხი თუ რა საერთო და რა განმასხვავებელი ნიშნები აქვს მინდობით აღზრდას სხვა მომიჯნავე ინსტიტუტებთან, კერძოდ, შვილად აყვანას, მეურვეობას და მზრუნველობას. რაც ძალზედ მნიშვნელოვანია თითოეული ჩვენგანისთვის, რათა ბავშვი აღიზარდოს ოჯახურ გარემოში და ჩამოყალიბდეს სრულფასოვან მოქალაქედ, მიიღოს განათლება და ჩადგეს თავისი სამშობლოს სამსახურში.

Foster Care Placement and its Differentiation from Related Institutions

Maskharashvili Khatia
The University of Georgia

Upbringing of and care for the child is an important function of the state. Parents are primarily responsible for physical, mental and moral development of the child; however, the state also assumes responsibility to take care of the child. The child belongs to the state and society. One of the fundamental functions of the family, among many others, is appropriate upbringing of children. A child is extremely sensitive and it is the family where the child gets to know the simple rules of moral behaviour, "good" and "bad" traits.

One of the most significant objectives of the Family Law is upbringing of the child in the family harmoniously combined with social upbringing which implies devotion to the homeland, readiness to contribute to development of the country.

It is the aim of the family to facilitate growth and development of an individual at a specific stage.

It is also noteworthy that the rights of the child are protected under the United Nations Convention on the Rights of the Child of 1959 the preamble of which states that "the child, by reason of his physical and mental immaturity, needs special safeguards and care, including appropriate legal protection, before as well as after birth."¹

"Children are the future citizens of the mankind. Upbringing of the child is one of the most significant objectives of our life. Our children represent our old age, bad upbringing implies our own future grief, our sorrow, it is our crime before the mankind, the whole country," these are the words of the great pedagogue Makarenko.

Family Law stipulates several forms of upbringing of the child in the family, of which the following are the most important: adoption, guardianship and trusteeship, foster care. Despite of the fact that all these institutions are aimed at protecting the rights of the child, bringing up and taking care of the child within a family, there is also an essential difference between them.

Foster care is very important for upbringing of neglected children and children deprived of parental care. One of the most significant objectives of the care for children is bringing up a child in a home and not in a children's home.

Foster care aims to ensure that children are brought up in a domestic environment and develop as full-fledged citizens, receive education and serve the interests of the country. Studying such institutions promotes improvement of the legislation in this field, protection of the rights of such children in the future and enhancement of their upbringing in the domestic environment.

Foster care placement dates back to 1998 when the President's special order "On State Supported Activities for Parentless Children" was adopted. It stipulated placing children with foster care-givers based on an agreement. A one-time allowance in the amount of GEL 500 and a monthly double minimum salary amount until the child is coming of age was allocated to the families who chose to accept parentless children, who were sent to state orphanages by their family members, for the purpose of care and guardianship. This money was intended to be used as a means of supporting foster care children, buy clothes and other necessary items.

Due to the fact that the order failed to settle all the issues with regard to the children deprived of parental care who were in the state custody, adoption of a normative act (law) was found reasonable. Remuneration of a foster caregiver was not defined separately. Adoption of the Law of 1999 "On Foster Care for Orphans and Children Deprived of Parental Care" was facilitated by high levels of awareness of the acute character of problems related to the upbringing of children and the keen interest in the issues raised in the President's order. By virtue of this Law, social relationships related to foster care were regulated, basic principles were elaborated, remuneration for child care and upbringing was defined separately, and such kind of activity was considered as the basis for calculating length of service. This Law was in effect for eight years.

As a result of legislative, political, and structural changes taking place in the state, it became necessary to clarify the content of specific provisions of the Law of 1999 and to consider certain amendments to it.

Consequently, a new Law "On Foster Care" was adopted on December 18th, 2007 aiming at providing a domestic environment to children and supporting the child's primary right to develop as a person, socialize and adapt to the society by means of the system of foster care, i.e. foster placement.

It goes without saying that such issues as the institution of foster care, the legal basis for its establishment and termination, its comparison with related institutions, such as guardianship and trusteeship, as well as adoption, are of great importance.

These issues are included in regulations which are stipulated by both domestic and international law.

Improvement of living conditions of children is regulated by the Law of Georgia "On Adoption and Foster Care." The new child care system serves as the basis for a healthy future, including facilitating integration of the child into the society, decreasing the threat of the influence of the criminal world on children deprived of parental care, narrowing of economic inequality, providing equal opportunities, and supporting social justice.

Georgia acceded to the United Nations Convention on the Rights of the Child on April 21st, 1994. The accession obliged the country to bring its domestic legislation in compliance with the aforementioned Convention.

Foster placement is one of several alternative ways of state care of a child which in the custody of the state. This institution is one of the most acceptable forms of care for children deprived of parental care.

Family is undoubtedly an essential and irreplaceable condition for development of a healthy and full-fledged individual. Children at children's homes lack parental love, care, affection, sibling relationship, and domestic environment. It is obvious that specialized children's homes cannot ensure harmonious development of the child and are unable to replace the family. Foster placement aims to deal with this specific problem and envisages temporarily placing the child with a family based upon mutual agreement between the state and the foster family. Consequently, foster care is one of the most important outcomes of the civil legislation. The child is entitled to the right to live and be brought up in the domestic environment for the purpose of full and harmonious development, if the child is left without parental care. Due to this fact, foster placement of the child is one of the most acceptable forms and care for such children is a high priority for the state. Accordingly, the state is obliged to supervise foster children who are in its care.

Child care became a pressing issue after the reform taking effect, particularly after the invasion of the Russian troops in August 2008 that created a difficult economic, social, and political situation, caused destruction of property and devastation of economic resources, claimed numerous lives, and deprived hundreds of children of parents and places of residence. Alongside with the provision of humanitarian support, all legal forms of child care and upbringing should be used to alleviate their plight, in particular foster care.

Often families cannot provide conditions appropriate for life and education. A lot of children from such families become inmates of children's homes at best and street wanderers at worst. This situation poses a serious threat to their future.

Analysis of foster placement and study of peculiarities of legal regulation was conducted based upon comparative, historic and logical approaches.

The practice of fostering parentless children (orphans) in families for the purpose of their upbringing has been a long-standing practice in Georgia. To this effect, funds would be allocated to foster families from the state budget (treasury). Later on, foster care incorporated different forms (protection, patronage). Then the state was no longer able to extend material assistance to foster families and the institution of patronage was incorporated into guardianship and trusteeship. Formerly applicable Civil Code (1964) did not stipulate patronage as a form of placing children deprived of parental care with families any more.

The Law on "Foster Care" defined legal principles of foster care, regulated relationship between the state and the foster family, determined the rules and procedures of foster placement, and guarantees of performance. It also defined the status and rights and responsibilities of the social worker engaged in the issues related to child care throughout the entire period of foster placement.

The Law "On Foster Care" adopted in 2007 did not serve as a sufficient basis for complete establishment of this institution and a new Law "On Adoption and Foster Care" was adopted in 2009 and took effect in 2010. It was due to the fact that these two significant institutions – adoption and foster placement – are similar to each other in a certain way and are almost similarly managed and regulated. The difference between them is in legal consequences, namely, in the case of adoption, biological parents are replaced and adopting parents acquire the status equal to that of biological parents. In the case of foster care, the state offers a domestic environment to children deprived of parental care that envisages maintaining all kinds of legal relationship between the foster child and the biological family.

State care is provided through the guardianship and trusteeship body represented by the Social Service Agency, according to the Georgian legislation. Competence of guardianship and trusteeship body includes care for underage persons who do not have legal representative or whose representative has restricted authority or has been deprived of representative authority.

Foster child retains the surname of the biological family and maintains connection with it. He or she is not an heir to the property of the foster parents. In case of foster care, the child is in touch with their parents and family members. This is the difference between adoption and foster care. In the case of adoption, biological parents are replaced with the persons expressing wish to adopt the child. Consequently, foster care is temporary (while the adoption is not).

Foster children are persons whose family, due to poverty or other reasons, is unable to provide proper upbringing and education to the child. Such parents agree to temporarily place them with foster families, as they are unwilling to place the children with children's home. Foster

parents are persons who temporarily perform functions of parents. They may not have children or have one or two children and willing to temporarily host foster children. This is effected by a mutual agreement between the state and the foster family.

Adoption is regulated by Article 6 of the Law of Georgia "On Adoption and Foster Care" which states that:

Subject to adoption is a registered person under 18 years of age that is granted the status of the child sought to be adopted. The status of the child sought to be adopted is granted to the person: a) whose parent (parents) was/were acknowledged by the state as incapable, recognized as missing or declared deceased; b) who is an orphan; c) whose is recognized as an abandoned child; d) whose parent (parents) was/were deprived of the parental right; e) whose all legal representatives gave their consent for the child to be adopted, according to the rule defined by the Minister and by means of filling in the relevant form.

In case of foster care, foster parents are entrusted with the upbringing of the foster child which means that they get allowance for upbringing of the foster child and the whole period of foster care is considered as a service. Moreover, they are entitled to tax benefits, namely they are exempt from income tax. Foster parents are allowed to work in public or private sector. Social worker is responsible for managing the process of care. Their primary functions include the following: The social worker is supposed to help citizens get involved in the foster care program; based on an application of the family, he or she shall examine the person (the minor) who is in need of special care and the condition of his or her families, as well as the condition of the applicant foster family. Following this, the Social Service Agency shall make a decision, within the limits defined by the law, on whether to grant the child the status of a child deprived of parental care, and then the foster care placement of the child. The social worker provides the relevant evaluation and opinion that will serve as the basis for further activity.

The scope of application of this Law increased considerably as a result of the legislative changes introduced in 2009 and is formulated as follows: The Law applies to citizens of Georgia, stateless persons permanently residing on the territory of Georgia, and citizens of foreign country willing to adopt or seeking to provide foster care for underage citizen of Georgia or a stateless person permanently residing in Georgia, as well as to citizen of Georgia and stateless person permanently residing in Georgia who, pursuant to this Law, are subject to adoption or foster care.

The legal bases for adoption and foster care, according to Article 3 of the 2009 Law of Georgia on "Adoption and Foster Care" are the fol-

lowing: The Constitution of Georgia, international agreements and conventions acceded to by Georgia, including The United Nations Convention on the Rights of the Child, The Hague Convention on Protection of Children and Co-operation in respect of Intercountry Adoption, The Civil Code of Georgia, the law of Georgia "On Social Assistance," the law of Georgia "On Adoption and Foster Care," as well as other legal acts.

The scope of application of Article 7 of the Law which provides the definition of *foster mother* and *foster father* increased considerably. According to the Law the following persons are entitled to this right:

1. Citizens of Georgia, stateless persons permanently residing in Georgia and citizens of foreign countries permanently residing in Georgia willing to extend foster care to the child (who should apply to the guardianship and trusteeship body according to their place of residence).

2. Foster mother/father can be any person of the full legal age, including a relative of the child, except:

A) The person acknowledged by the state as incapable or of restricted capacity;

B) The person whose parental or guardianship/trusteeship rights and responsibilities are restricted, as a result of non-fulfilment of the obligations assumed under the Law;

C) The person who is unable to take care of the child due to deterioration in health condition;

D) The person who or whose family members have been convicted for a grave or especially grave crime, as well as the person who or whose family members have not been exonerated or discharged in accordance with the procedures defined by the Georgian legislation;

E) The parent, foster care-giver, guardian and trustee of the child who bear the responsibility to support the child.

A local branch of the Social Service Agency has the authority to carry out the foster care procedures, including identifying a person subject to foster care and a person seeking to accept the foster child within the administrative-geographic area it is responsible for, registering the person subject to foster care (foster child), the person seeking to accept the foster child (foster mother and father), and systematize information on these persons, conducting an assessment of the person seeking to

foster a child and the foster child, analysing the compatibility between the person seeking to foster the child and the person subject to foster care, considering the negative criteria (except for emergency cases of foster care), elaborating the plan of individual development of the child and monitoring implementation of this plan, supervising the living, educational, development, health conditions of the foster child, as well as fulfilment of obligations assumed by foster mother/father, providing consultations, within its competence, on issues of foster care, and exercising other prerogatives granted to it by the Georgian legislation.

Registration shall include the following steps: The person willing to provide foster care for a child should apply to the local guardianship and trusteeship agency (based on their residential address), fill in the special application form (annex 1), and in the case of an emergency foster care registration, attach the following documents:

- A) Identification document (the ID card, passport or residence permit of the applicant) and its copy;
- B) Criminal Record;
- C) Health certificate (Form IV-100a);
- D) Drug check-up, if the health certificate does not contain the relevant information.

The social worker shall, no later than 10 working days from the receipt of the application, provide an initial assessment of the person/family willing to extend care to the child and include his or her opinion. Should the social worker's assessment be negative, the local branch of the guardianship and trusteeship agency shall make a decision to decline the registration of applicant foster mother/father. Shall the local guardianship and trusteeship agency refuse to register the applicant foster mother/father, they may re-apply to the local guardianship and trusteeship agency for registration as foster mother/father after one year. Should the initial assessment of the applicant(s) be positive, the social worker no later than 15 working days provides a comprehensive assessment of the family and his or her opinion to be submitted to the local guardianship and trusteeship agency.

The Civil Law provides both the basis for foundation of this institution and termination of the rights and responsibilities of the participants of the aforementioned legal relationship:

Article 33 of the Law of Georgia of 18 December 2009 "On Adoption and Foster Care" stipulates that a foster care agreement may be terminated in the following cases:

- a) On the initiative of the foster family, due to substantive reason (illness, deterioration of health or economic condition, conflict between the foster child and the foster family members);
- b) On the initiative of the guardianship and trusteeship agency, due to adverse conditions and environment for child care;

- c) In case of return of the foster child to its biological family;
- d) In case of adoption of the foster child;
- e) In case the foster child attains the legal age of majority;
- f) In case of the foster person is getting married;
- g) In case of abrogation of the basis stipulated by Article 8 of this Law;
- h) Upon termination of the validity of the agreement.

Agreement on foster care is also regulated by Order 51/n of 26 February 2005 of the Minister of Labour, Health and Social Affairs of Georgia "On Approving Procedures and Forms of Foster Care," Article 17 of which enumerates a list of restrictions for termination on foster care. These include the following:

- A) Termination of the agreement, if its term has not been extended;
- B) Foster mother/father filing an application for cancellation of their registration;
- C) Passing away of the foster mother/father;
- D) Passing away of the child;
- E) Returning of the foster child to his or her biological family;
- F) The foster child coming of age;
- G) The foster person getting married;
- H) On the initiative of the foster family, due to substantive reason (illness, deterioration of health or economic condition, conflict between the foster child and the foster family members);
- I) On the initiative of the guardianship and trusteeship agency, due to adverse conditions and environment for child care;
- J) In all other cases stipulated by the Law of Georgia "On Adoption and Foster Care."

The agreement on foster care can also be terminated on the initiative of the foster family, due to substantive reason (illness, deterioration of health or economic condition, serious conflict between the foster child and the foster family members). In this case, taking into account the interests of the foster child, it is reasonable to terminate the agreement.

Civil Law stipulates three forms of child placement: Guardianship and trusteeship, foster care, and adoption. All of these institutions ensure protection of the child and are closely interrelated; however, there are a lot of differences between them as well.

Above was mentioned the difference between a foster child and an adoptee. Adoption can be allowed only if the interests and welfare of the child is the basic concern and if it is probable that the relationship will be formed between the adopter and the adoptee as that between the parents and the children.

Adoption dates back to the Roman law where adoption was aimed to exert influence of the adopter on the children of another family by means of establishing kinship ties with them. An adoptee was released

from obligations to their previous family and was totally accepted in the adopter's family.

At the initial stage, adoption was stipulated by the necessity to have a son in the family as the religious tradition obliged a family to rear a son for the purpose of protecting the sanctity of family. If a family was unable to have its own son, it had to adopt somebody else's. During the period of class division in Rome, adoption became a political method for noble patricians to maintain and continue their noble clan as well as to replenish and renew low and middle class of the patricians.

Academician Iv. Javakhishvili stated that the document in feudal Georgia certifying adoption was called "Adoption Book" or Charter. The existence of a special document indicates that the institute of adoption was widespread in the feudal Georgia. With regard to inheritance, an adoptee enjoyed the same rights as the family's own son.²

Adoption should ensure that interests and moral views of the underage child shall be considered, but equally significant is clarifying such issues as are defining the participants of the adoption process, as to who adopters and adoptees are going to be.

Participants in the adoption process are adopters and adoptees, in consideration of the age defined by the regulations of the Code.

It should be noted that the decision on adoption must be registered at the Territorial Service of the Civil Registry Agency according to the place of decision making. Authenticity of adoption, rights and responsibilities of the adopters and adoptees as well as of their relatives, take legal force upon the court decision being rendered, however their registration at the Territorial Service of the Civil Registry Agency is of paramount significance with regard to the protection of the child's rights and interests. The registration certifies the fact of adoption and ensures the integrity of the adoption. The aforementioned Agency makes relevant amendments to the records in relation to the given name, patronymic, and surname of the adoptee, place and date of birth of the parents and issues repeated certificates based upon the corresponding act record.

Adoption implies permanent relationship between the adopter and the adoptee; consequently, this form of placement is not used when the child is temporarily deprived of parental care or when the condition of health of the child does not allow his or her adoption. In some cases when children remain in the families who actually rear them but do not express wish to adopt them, guardianship and trusteeship agencies do not find it reasonable to place them with an adoptive family. In this case guardianship and trusteeship can be provided.

The Law does not equal relationship of guardians and trustees to that established by kinship. From the legal standpoint the adoptee is fully equal to the family's own children. Adopters and adoptees gain the

same rights and responsibilities as those that exist between the parents and the children.

The Civil Code of Germany gives the picture of the institute of adoption similar to that of Georgia.

According to the Civil Code of Germany adoption is allowed only under condition that the child's welfare is ensured and the same relationship is established as that between the parents and the children. A person who supported the mediation that was against the moral principles and the Law on adoption, or who transferred the child for the purpose of adoption and/or assigned or paid a price to the third person to this effect, can adopt the child only if it is indispensable for the child's welfare.

A (unmarried) single person may adopt a child individually only.

It is also noteworthy that the German legislation sets the age of 25 as the age for a person to become eligible to adopt a child.

Consent of the child is necessary for adoption, on behalf of incapable child or the child who has not yet reached 14 years of age, consent is given only by the child's legal representative. In other cases the child can give his/her consent personally only.

If the adopter and the adoptee are citizens of different countries, the consent should be approved by the Family Court. This rule does not apply, if German law is applicable with regard to adoption.

Decision on adoption is made by the Family Court based upon the application of the adopter.

It is inadmissible to file an application conditionally or by specifying the term. It should be notarized.³

Guardianship and trusteeship is similar to foster care and adoption. Guardians and trustees fulfill the same responsibilities, but they have certain rights restricted, are subject to supervision and are accountable to state guardianship and trusteeship agencies.

The institution of guardianship and trusteeship is one of the most ancient in the history of law that dates back to the law of Ancient East and Rome. These institutions were regarded as institutions of custodianship there.

The Roman law extended care to those persons as well who did not have a care-giver, or those who were deprived of paternal care or whose parents were deceased. Subject to care were also persons suffering from mental illness.

The institution of guardianship and trusteeship protected and managed the property, interests and rights of the persons under guardianship and trusteeship. A person having close relationship with the family of the person under guardianship, such as family member or kindred, was mainly appointed as guardian.

The fact that preliminary agreement between parents and guardians was necessary for marriage in Rome and Ancient Greece also indicates to existence of the institution of guardianship and trusteeship. Such agreement was mainly prerogative of the guardian or the parent, as infants were usually “engaged”.

As we can see the institution of guardianship and trusteeship played a very significant role in matrimonial and domestic relationships in Ancient Greece, Rome, and Byzantium.

The term “guardianship” and “trusteeship” means performing exactly the same function as is implied by the purpose of this institution. Dictionaries do not provide any other specific definition of this term. The Georgian word for this institution is the same as its name and literally means supervision, custodianship extended to a person.

According to the Civil Code of Germany, a guardian is assigned to an underage person, if this person is deprived of parental care or the parents are not entitled to represent the underage person both in relation to personal and property issues.

Guardian is appointed by the Family Court at its initiative. If it is considered that a guardian needs to be assigned to a child from the moment of his/her birth, the guardian can be assigned prior to his/her birth. The assignment itself takes effect upon the birth of the child.

Guardianship is terminated by the elimination of the precondition stipulated for ascertaining guardianship.

There are a lot of common issues between the German and Georgian legislations. It is important to differentiate them.

Guardianship and trusteeship do not stipulate the property related rights and responsibilities equal to those of parents; consequently, there is no requirement to register guardianship and trusteeship in the state agency.

Guardians and trustees are not obliged to support the children under their guardianship. In case of insufficient resources, the guardianship and trusteeship agencies allocate allowances to guardians and trustees.

Total number of children in the receiving family, including the family’s own children, should not exceed eight. Age difference between the parents seeking to accept the child and the child sought after should not be less than 15 years.

Children with disabilities, poor health or less advanced children can be transferred only if the family gives consent to accept them and who have appropriate conditions, in the first place financial and material means. These conditions should be indicated in the opinion provided by the guardianship and trusteeship body.

Development, change of content and termination of other forms of guardianship, trusteeship or care are subject to the law of the country

where a person to whom care is extended belongs. Foreigners or refugees residing in Georgia can be assigned guardian or trustee, according to the Georgian legislation.

If it is necessary to implement the procedures for guardianship but it is not defined as to who is going to participate in this process, or if the participant is in another country, the law of that country is applied which is most beneficial for the person to whom guardian is to be assigned.⁴

Child transferred to receiving family for upbringing retains the right to receive alimony, pension and other social allowances and compensation that are transferred into the bank account opened in the name of the child. Alimony, pension and allowance granted to the child placed with the receiving family are used by the receiving family to support, bring up the child, and ensure his/her education, considering restrictions defined by the legislation for guardianship and trusteeship.

Monetary funds are allocated from the state budget to receiving families to support each child they accept, considering such expenses as: clothes, shoes, everyday items, toys and books. If the child is placed with the family for more than one year, additional funds are allocated to purchase necessary furniture. These funds are allotted by the local body of self-government (government) for receiving parents throughout the whole period of the agreement.

The amount of monthly allocation is defined by the local body of self-government (government) based on the regulations for material support, considering prices defined in the specific region.

The law emphasizes that guardian and trustee are assigned voluntarily and free of charge.

Guardianship ceases as soon as the child reaches 7 years of age and the guardian becomes trustee without any particular permit. Trusteeship is terminated by the decision of guardianship and trusteeship agency when the child turns 18 years old.

Receiving parents are not entitled to prevent the relationship between the child and his/her parents and close relatives, if such relationship does not counteract with the child's own interests.

Guardianship and trusteeship agency issues a certificate to receiving parents indicating the parent's surname, given name, patronymic and address, date and number of agreement, as well as the child's surname, given name, patronymic and date of birth.

According to Article 1289 of the Civil Code of Georgia, guardians (trustees) are obliged to support the child they receive. Obligations of guardian and trustee are fulfilled free of charge. The child retains legal relationship with parents or close relatives subsequent to assigning a guardian. Consequently, close relatives have a responsibility to support the child and if such persons are not available, a pension or allowance is

allocated to the child. Guardianship and trusteeship agencies allocate allowance to the guardian or trustee for the purpose of supporting the child, if sufficient funds are not available. Like guardianship and trusteeship, adoption is also free of charge. Adopted child, as mentioned above, is legally equal to the family's own children.

The adopter assumes full responsibility to fulfil the obligations of the parent. Unlike adoption, guardianship and trusteeship, foster placement implies that paid agreement is concluded between the state and foster family that serves as the basis for transferring the child to the receiving family for the purpose of extending care and providing upbringing. Agreement on foster care significantly differs from other civil and legal agreements with its content and the rule of conclusion.

The agreement can be terminated on the initiative of the guardianship and trusteeship agency, when it becomes evident based on the opinion of the social worker that conditions have arisen that are inappropriate and/or harmful for the child.

In case of premature termination of the agreement on foster care, the child is transferred to the guardianship and trusteeship agency that shall take measures stipulated by the Georgian legislation.

As adoption is only legal relationship (not biological), the law envisages the possibility for its termination and relates it to certain legal circumstances.

The law stipulates termination of adoption: by cancellation of adoption and recognizing adoption as invalid.

Cases related to cancellation of adoption and recognizing adoption as invalid are relegated to the category of child-rearing cases. Consequently, the court considers them, if guardianship and trusteeship agencies are participating, no matter who has submitted the relevant request. Guardianship and trusteeship agency submits to the court an act on the conditions of the life and upbringing of the child in the adoptive family reflecting all the circumstances essential for decision making and issues an opinion upon verification, based upon this act, with regard to the case. The opinion should give the basis and motivation for the decision which is essential for establishing further relationship.

If the requirements of the law are violated during adoption, adoption can be cancelled, proceeding from the child's interests.

Deprivation of parental right does not cause cancellation of adoption in any case. If the child has reached 10 years of age, his/her interests should by all means be considered. Adoption can be cancelled by the court only and the relevant motive that stipulated cancellation of this act should be indicated.

Cancellation of adoption is final and for deprivation of parental right, the law considers possibility of its resumption.

Persons who consider that adoption does not serve the child's interests and that it should be cancelled, should submit the relevant information to guardianship and trusteeship agency that will make decision regarding the request for cancellation of adoption.

References

- Chavchavadze, I. *Works*, Vol IV.
United Nations Convention on the Rights of the Child of 1959
Shengelia R., Shengelia E. (2009). *Family Law*. Tbilisi.
The Law of Georgia of December 18th. (2009). *On Adoption and Foster Care*.
The Law of Georgia. *On adoption and foster care*.
www.mes.gov.ge
Civil Code of Germany. (2010). (as of March 1st, 2010), (p. 303), Tbilisi.

Endnotes

1. United Nations Convention on the Rights of the Child of 1959;
2. Iv. Javakhishvili, (1926). *Georgian Historical Documents i.e. Diplomatics*, p. 47. Tbilisi.
3. Civil Code of Germany. (2010). (as of March 1st, 2010), (p. 303). Tbilisi.
4. Roman Shengelia, Ekaterine Shengelia. (2009). *Family Law*. (p. 462). Tbilisi.
5. Chavchavadze, I. *Works*, Vol. IV, p. 364-365

სამეწარმეო საქმიანობის განვითარება და მისი სამართლებრივი რეგულირება

*ტრაპაიძე ნატო
საქართველოს უნივერსიტეტი*

პუბლიკაცია არის საქართველოსა და უცხოეთის ქვეყნების სამეწარმეო სისტემის საკითხების პრაქტიკული სისტემური ანალიზის მცდელობა. მიუხედავად იმისა, რომ ბოლო პერიოდში მრავალმა ავტორმა არაერთი მონოგრაფია თუ წერილი მიუძღვნა დღევანდელ საქართველოს სამეწარმეო კანონმდებლობის სფეროს, ქართული კანონმდებლობის სხვადასხვა ქვეყნის კანონმდებლობასთან შედარების სერიოზულ ნაკლებობას განიცდის ქართული მეცნიერება და პრაქტიკა. 1994 წელს მიღებული „მეწარმეთა შესახებ კანონი“ არაერთხელ მოექცა კანონმდებლობის მხედველობის არეში და მნიშვნელოვან ცვლილებებს დაექვემდებარა, დღეისათვის კი საქართველოში კერძო საწარმოთა საქმიანობის სამართლებრივი რეგულირება, საწარმოთა ფუნქციონირების, მათი ორგანიზაციულ-სამართლებრივი ფორმები, თითქმის შეესაბამება განხილული ქვეყნების კერძო სამართლის სუბიექტების მოწყობის ზოგადად პრინციპის, საქმიანობის საგანსა და ფორმებს. პუბლიკაციაში მოყვანილია სხვადასხვა ქვეყნის სამეწარმეო სისტემა, მათი უფლებაუნარიანობის წარმოშობა, საჭირო დოკუმენტაცია, მათი მართვა და ა.შ.

Development and Legal Regulation of Entrepreneurial Activities

*Trapaidze Nato
The University of Georgia*

Development of the entrepreneurship is priority area in Georgia as one of the countries with transitional economy that operates economic activities in the market, has established market infrastructure and implemented the reform of economic radicalization. Exactly this is the goal of economic reforms oriented at revival and development assistance of entrepreneurial activities. Entrepreneurial activities have always been highlighted in Georgia: historically it was emphasized by kings and feudal

lords and nowadays the state focuses attention on its development. The entrepreneurship is first of all the lifestyle and only after that the source for generation of profit in the United States of America and due to the above reason active business is especially assisted there. The entrepreneurship is considered to be the factor of improvement welfare of population in Germany. In the near future, we shall see that the entrepreneurship becomes the basis of economic development of Georgia and the guarantee of development of activities carried out by an entrepreneur and proprietor.

Fifteen years have passed from the first codification of corporate law in Georgia. The law on entrepreneurs laid the foundation for a new market economic system based on the private initiative and private property. The first commercial enterprises, whether Joint Stock or Limited Liability Companies were founded and developed in compliance with this law. In my opinion, the new Georgian economy was established by entrepreneurial entities founded under this law.¹

My attention attracted economic situation, development of entrepreneurship, trade and other relations of Biblical countries. The Lord grants riches, property, and wealth to a man and also talent to manage, take his portion and savour his work. All this is grace and blessing of the Lord.² It is true that the goal of authors of the Bible was not to deliver information reflecting the life of the countries and their population, but archaeological finds gave us an opportunity to get sufficient supporting materials for issues that are not directly considered in the Bible (period of the Old Testament) such as commerce, deals and relations in entrepreneurial activities, namely what ate, how dressed and what kind of relations used to establish the people of that period.

According to the Bible, in the period of the Old Testament the head of the household fulfilled the work that nowadays is considered to be professional occupation: the items meant for direct consumption were processed and produced. The architecture and buildings of that period distinguish themselves with a rather high level of taste. Fortifying of cities was especially important. Construction of strengthening, fortifying and residential objects was carried out in Egypt, Israel, Babylon and other countries. For example, Jerusalem built by Solomon, Cheops Pyramid and other pyramids, Babylon and etc. From the aforesaid we can mention for instance evidences reflecting the work of craftsmen and masters as well as development of construction, commerce and trade routes in the Biblical period that is activities operated by the first private entrepreneurs and group interest manufactures³.

The necessity to regulate development of entrepreneurial activities by certain norms gradually became evident in ancient times. Rather interesting is the origin and historical development of entrepreneurship. Taking into account historical development of entrepreneurial activities and

entrepreneur's views, the entrepreneur is considered to be founder of business who better than anyone knows and can perform his work, opens new enterprises, creates working places, operates business and knows which sources are necessary for conduction of business, distributes these sources taking into account expenses, controls all charges, defines the scope of income, generates profit, acts basing on principals of Christian psychology, charity and welfare of the country.⁴

The Scotsman John Lee became the founder of the French Royal Bank and Mississippi Company, took in his hands the whole trade monopoly between France and Mississippi being a part of France in that period (XVIII century). His astounding success did not last for a long time; he became bankrupt as a result of one inconsiderate action: he issued shares that significantly exceeded the sum of his assets. R. Kantilion analyzed mistake made by John Lee and delivered characteristic of an entrepreneur acting under risk⁵. The entrepreneurship became formed already in the XVIII century; there were defined significant differences existing between capital owner and trader. The first operates the capital, provides its turnover, creation of new working places and generation of profit. So the function of supplier of the capital was separated from the function of capital market, risk capital and entrepreneurial activities. It was the Era of Entrepreneurial Revolution. The roles of entrepreneur and owner of the capital were determined exactly in that period (Spyros Makridakis "Forecasting, Planning and Strategy of the 21st century").

Development of business is rather closely connected with the subject of my research, that's why I decided to begin my work with general consideration of business and entrepreneurship. Achievement of success in business is impossible without clearly defined and regulated relations. From this viewpoint, the Georgian entrepreneur faces many challenges. Entrepreneurial activity is connected with permanent establishment of new relations in the course of business and these relations must remain in the framework of law and legality. There are several ways for resolving these problems. One of the possible solutions is that the entrepreneur carefully studies the law at least to the extent that is necessary for everyday management of his company. Another way is to employ a highly skilled lawyer or consult competent law firms. Development of the human society began with natural exchange of foodstuff and simple household items in ancient times. Further began realization of these goods. Due to great demand in various products in the society, business was operated in various directions. Under legislation of Georgia and according to international norms, the subjects of commerce law, i.e. individual entrepreneur natural persons, co-owners of corporations and owners of corporate capital (shares) are entitled to operate any kind of business that is not forbidden by legislation.

The entrepreneurship/entrepreneurial activity is often called business. Obvious is that business is associated with entrepreneurship/entrepreneurial activity. The following terms are used in the legislation of Georgia and works of Georgian scientists: entrepreneurial law, commercial law, trade law, corporate law, business law and etc. Nowadays the following terms are generally used in the norms of international law, legislation of Georgia and works of Georgian and foreign scientists: corporate that is entrepreneurial law. Noteworthy is that the term "entrepreneur" and not "corporation" is used in the Law of Georgia "On entrepreneurs" dated the 28th of October 1994. The term "corporation" is not used and defined in legislative acts of Georgia. The word "business" is of American origin and has various meanings in the laws issued in English language. From linguistic viewpoint, the term "business" means professional occupation of businessman who carries out entrepreneurial activities aimed to generation of profit. In the majority of cases, the term "business" is elucidated as active, repeated, legitimate action based on establishment of business relations and aimed at generation of profit. Proceeding from all the above-mentioned, definition of business is wider than of entrepreneur due to multilateral direction of its development.⁶

Rather interesting is legal regulation of entrepreneurship in foreign countries. Legal norms regulating foreign economic relations of entrepreneurial activity inside the country take significant place in the legal system of developed countries. One group of international law specialists considers these norms to be a part of private law. The second group thinks that these legal norms represent separate branch of the law that is called business law in many countries of the world; is known as the Law "On entrepreneurs" in Georgia. Natural persons and legal entities in the most countries of the world are entitled to operate business related activities regulated by legal norms.

Very interesting is to consider organizational and legal form of enterprises existing in the United States of America, the procedure of registration of these enterprises, documents required for registration and authorities carrying out the registration.

By legislation of the United States of America is envisaged entrepreneurial activities carried out by private entrepreneur (owner of enterprises that according to the official statistics belong to private enterprises and universal partnerships or limited liability companies) and corporation.⁷

A natural person willing to be granted the status of entrepreneur must apply to local authority of any state and obtain a license for operation of certain type of business. General Limited Liability Partnership is founded basing on the agreement concluded between partners and does not represent a legal entity. Founder-partners are obliged to meet the following requirements: the first, equal distribution of income and losses

between partners; the second, joint control of business and active participation in activities carried out by the partnership; the third, all partners are jointly liable to creditors to the extent of their property.

General Limited Liability Partnership is founded as a rule by a highly skilled specialist in the field of law, architecture, finances and bookkeeping, medicine and other services. The partners of the General Limited Liability Partnership assume liability to creditors. Their liability and participation may be limited in proportion to their deposits. The enterprises of this organizational and legal form are generally founded for operation of construction and mounting business, acquisition and application of natural resources, conduction of real estate related and other kinds of activities. The difference existing in the aspect of liability is rather obvious and the goals of foundation of this legal enterprise are specified in the legislation; these goals are not so definitely prescribed in the legislation of Georgia. In spite of this fact, all legal forms are destined for conduction of any activities not forbidden by current legislation. In addition to the aforesaid, noteworthy are the following differences existing between the US legislation and legislation of other countries: the tax code prescribes that the taxes shall be paid not by an enterprise but by partners in proportion to their income; these taxes are payable by an enterprise in other countries and in Georgia. Legal status of corporations is regulated by legislation of the United States of America. For registration of corporation, the charter must be submitted and the application must be filed with the state secretary. The subject and purpose of cooperation specified by the charter may include any kind of activities allowed under the US legislation. Name of cooperation (association, club, institution, foundation, company, union, syndicate and other) shall be specified in the charter. Place of business, founders and legal address of the company, directors and their addresses shall be exactly indicated in the charter. The corporation is considered to be registered after registration of the charter of corporation by the state secretary. Emission of shares can be stipulated the charter of corporation. In such case obligatory is to specify the scope of capital, class of shares and nominal cost of shares in the capital. Management of corporation is carried out by general meeting. Labour capacity of manager of corporation can be defined by regulation of the board of directors. Manager of the corporation shall be appointed by general meeting of the corporation or on the grounds of resolution made by the board of directors. From the aforesaid are obvious certain differences existing between legislations of other countries and legislation of Georgia; however, especially noteworthy are the rules of registration. The function of the National Agency of Public Registry is granted to the secretary of the United States of America. The US legislation is rather interesting in this aspect and as much interesting is its application in practice.

In compliance with the French legislation, legal entities (Personnes morales) are divided into legal entities of private law and public law. Legal entities of private law are legal entities of commercial law, i.e. traders. A legal entity of public law operating commercial activities is regulated by the norms of commercial law. Definitions of legal entity and commercial trader are prescribed by the Commercial Code of France. According to the Commercial Code of France, commercial trader is a person who is involved in the entrepreneurial activities and makes it for his/her profession. For operation of these activities a person shall be registered by a judge of commercial or general court and incorporated into trade register. Commercial trader may be a member of Limited Partnership or owner of a private enterprise. Commercial trader is liable to creditors to the extent of her\his property. Status of legal entity of private law is generally determined by the Law of France "On commercial companies" issued in 1966 and Decree "On commercial companies" passed in 1967. Organizational and legal forms of entities of private law are determined basing on these normative acts: the first, the General Partnership; the second, Limited Partnership; the third, Joint Stock Company, the fourth, Joint Stock Commandite Company; the fifth, Limited Liability Company.

General partnership (Societe en nom collectif) is a legal entity. Its members assume full and social liability to creditors; their liability is valid in the period of functioning of the company and within five years after its liquidation. The scope of minimal capital required for foundation of the company is not specified.

Limited partnership (Societe en commandite simple) can be founded by legal entities and individual traders. Members of limited partnership are liable to creditors in proportion to their deposits. Information about members of the Company must be published.

Joint Stock Commandite (Societe e commandite par action) is a legal entity founded by no less than one trader and three shareholders.

Limited Liability Company (Societe a responsabilite- SARL) assumes liability to its creditors to the extent of its property. Founders of a Limited Liability Company may be both natural persons and legal entities. If founder of the Company is a sole person, it is called "Sole Limited Liability Company". Maximal number of founders must not exceed 50. If the number of founders exceeds 50, the Company must be transformed into Joint Stock Company within the period of two years. Supreme body of the Company is meeting of founders. Convocation of annual meeting and establishment of collective body - supervisory board are mandatory when the number of founders exceeds 20. The supervisory board is staffed by at least three persons.

Joint Stock Company (Societe Anonyme - SA) is entitled to issue ordinary and preference shares. Its authorized capital is the same as in case of Joint Stock Commandite. The supreme authority of the Company is

meeting of partners. The Joint Stock Company is obliged to publish its balance, profit, losses and final annual results of the Company.

Authorized capital, increase or decrease in the number of founders is determined for almost all legal and organizational forms in France. The French legislation is more exacting in comparison with other countries; under exactingness is meant availability of many requirements and documents required for foundation of an enterprise of any legal and organizational form in France.⁸

According to the legislation of Great Britain, natural persons are entitled to operate business related activities on individual basis or enter into a new association – partnership. A natural person does not need any additional registration to become a “trader”. Obtaining of a license is mandatory, if a natural person intends to operate business subject to licensing provided for in the legislation. Special law “On General Partnership” (Partnership Act 1890) is passed in the United Kingdom of Great Britain. Operation of such form of business is not associated with status of a legal entity. General partnership does not represent legal entity under the legislation of Great Britain; state registration is not required for its registration. Activities of partnership are determined by agreement made between partners. The partners are jointly liable to creditors; the sum of the liability shall be divided between partners. Organizational and legal form of Limited Partnership is envisaged by legislation of England (Limited Partnership Act 1907). The majority of private enterprises in Great Britain are companies. According to the legislation (Companies Act 1958), the companies are legal entities that may be founded by at least two persons. Member of the company may be natural person or legal entity. The following organizational and legal forms of an enterprise are provided for in the legislation: the first, a Company Limited by Shares; the second, a Company Limited by Guarantee; the third, an Unlimited Company; the fourth, Public Companies. The majority of companies are limited liability companies (Ltd). Legal nature of this enterprise is similar to the Limited Liability Company envisaged by legislation of Georgia.

An enterprise is considered to be a Public Company if its public status is directly defined in the articles of association–memorandum. Such companies are obliged to have authorized capital; they assume liability to creditors to the extent of this authorized capital. Amount of the authorized capital must not be less than 50 thousand pound sterling. Availability of authorized capital at the moment of foundation of the company is not binding for private companies and minimal rate of deposits to be paid to the authorized capital is not defined. It must be noted that both private and public companies enlisted here are legal entities operating as a rule a small-scale and medium-scale business.

The documents required for foundation of the aforesaid companies is memorandum and internal regulations. Trade name, address, subject of

activities and authorized capital of a company shall be mentioned in the memorandum with indication of shares belonging to each founder.

State registration is carried out by official person of registration authority - registrar of companies. Obligatory is payment of registration fee and symbolic (emblem) and submission of the articles of association, application and information about director and first secretary. After registration of the aforesaid information, the legal entity is considered to be registered and special certificate is issued.

In addition to the stated above, I have considered legal entities of Germany, their registration and origin of their competence. According to the German legislation, legal entities of private law are divided into associations or partnerships (Vereine) and institutions (Stiftungen). The law provides for the following legal and organizational forms: the first, Commercial Company (Partnership); the second, Limited Liability Company; the third, Joint Stock Company; the fourth, Cooperative. Under the legislation of Germany, commercial companies (partnerships) are not legal entities, but they are granted certain legal competence, they are entitled to act as a plaintiff and defendant in the court. Their activities are regulated by the Civil Code of Germany. The legislation of Germany foresees four types of commercial partnerships: the first, Limited Commercial Partnership and the second, Limited Partnership. Commercial Partnerships are joint ventures founded for achievement of common purposes. Liability of founders to creditors is not limited; they are jointly liable for all indebtedness of the company. Property of the company represents private and joint property of its founders⁹.

Limited Partnership (association) assumes full liability to its creditors, but its commandites are liable to creditors only in proportion of their deposits.

Limited Liability Company is regulated by the law "On limited liability" passed in Germany still in 1892. These companies are very popular in Germany. The limited liability company represents legal entity and is granted full legal competence and authorities. The document required for foundation of the company is agreement made between partners. Agreement of partners must include the following information: trade name, place of business, subject of activities, amount of the authorized capital, monetary deposits of each founder partner. Governing organ of the Company is general meeting and director.

Entrepreneurial activities in Russian Federation are regulated by the Civil Code, the law on commercial company and other normative acts. The law provides for the following legal forms: the first, Private Entrepreneur; the second, General Partnership and Limited Partnership; Limited Liability and Additional Liability Company; the third, Public and Closed Joint Stock Companies; the fourth, Cooperative; the fifth, State and Municipal Enterprises;

The simplest legal form is private entrepreneur, who acts solely and does not represent a legal entity. The private entrepreneur assumes individual liability to creditors to the extent of his/her property. General partnership represents unification of several entrepreneurs and commercial organizations into one company for conduction of joint activities. Agreement concluded between partners represents precondition for foundation of a general partnership. Minimal amount of the capital is not determined by legislation. The majority of enterprises are limited liability companies that represent legal entities. Its founders may be physical persons and legal entities. The state or local self-government authorities may not be founders of a company.

Functioning of a Joint Stock Company is regulated by the "Civil Code and Federal Law of Russian Federation" "On Joint Stock Companies". The capital of a Joint Stock Company is divided into two types of shares: the first, open shares that can be purchased by any person and the second, closed shares that can be purchased by founders of the company only. The supreme governing body of the Joint Stock Company is meeting of shareholders that shall be convoked at least once per annum. Management of the Company may be executed also by the board of directors and council of founders.

Cooperative is founded for operation of joint activities. Members of cooperative personally take part in its work and contribute their shares to cooperative. According to legislation, the number of cooperative members must not be less than five. The document required for foundation of a cooperative is cooperative charter approved by members of cooperative. Management is carried out by general meeting and executive authority-administration.

The law has been more than once amended in Georgia from the day of its passing until now. Notwithstanding successful or unsuccessful outcomes of such changes, they are evidence of historical process of development of the corporate law in Georgia. Each epoch faces new challenges. As a result of many changes introduced into the law on entrepreneurs passed in 1994, the law became obsolete and many of its provisions became inadequate to contemporary requirements.¹⁰

Amendments are constantly made to this field and ignoring these changes is inadmissible in the process of codification of the corporate law. Correspondingly, fundamental changes were introduced into the Law of Georgia "On entrepreneurs" and came into effect from the 1st of January 2010.

Regulation of entrepreneurial activities and legal and organizational forms of enterprises, their foundation, rules of registration, rights and obligations of partners, as well as many other aspects connected with entrepreneurial activities are generally based on the Law of Georgia "On entrepreneurial activities" passed in 1994. This law regulates only legal

form of entities carrying out entrepreneurial activities and not relations established in the course of entrepreneurial activities. In compliance with article 1 of the Law of Georgia "On Entrepreneurs", entrepreneurial activity is considered to be only legitimate, repeated, organized and independently operated business oriented at generation of profit. Proceeding from the above-mentioned, key signs of entrepreneurial activities are as follows: legitimate activities; repeated activities; independent operation of business; organized management. According to the theory of law, legitimate is considered to be any kind of activities that does not contradict to the current legislation and moral norms, customs and habits established and recognized in the society. Certain kinds of activities are directly forbidden under the legislation of Georgia, for example, illegal production and sale of pornographic and other products is forbidden and prosecuted according to the Criminal Code of Georgia. Correspondingly, legitimate is considered to be activity that is not directly forbidden by normative acts. The enterprise of any legal and organizational form is oriented at regular operation of activities foreseen by the charter and allowed by legislation within uncertain period of time. The legislation has recognized the following legal forms of enterprise: the first, Individual Enterprise; the second, Joint Liability Company; the third, Limited Partnership (LP); the fourth, Limited Liability Company (Ltd); the fifth, Joint Stock Company (JSC); the sixth, Cooperative.

An Individual Entrepreneur being the owner of an individual enterprise shall be an individual whose entrepreneurial activities must necessarily be based on an organization established on an entrepreneurial basis and maintaining proper accounting records. Such an entrepreneur shall act in legal relations in his/her own name.

In spite of the fact that individual enterprise is not a legal entity under the Law of Georgia "On entrepreneurs", an individual entrepreneur, i.e. natural person, shall act in his/her own name as an independent person. An individual entrepreneur conducts activities connected with individual enterprise solely and assumes personal liability to creditors to the extent of his/her property. According to the form of individual enterprise provided for in the legislation, it can be a small-scale or medium-scale enterprise. For the time being, the current legislation determines registration of an individual entrepreneur according to the place of residence. An individual entrepreneur must be incorporated into Entrepreneurial Register conducted by Service Agency of the Ministry of Justice of Georgia.

Besides, I would like to emphasize the essence and purpose of the registration of entrepreneurs. As a rule, state registration of entrepreneurs is carried out in all countries of the world. I have already mentioned the procedure of state registration in various European countries (France: by the law on commercial registration; Germany: by the Com-

mercial Code; USA: by separate laws on corporations and partners valid in various states). Different are also authorities carrying out registration (France: registration is carried out by the Secretary of Commercial Law; USA- by the State Secretary and etc.). According to the Law of Georgia "On entrepreneurs" passed in March 1995, the registration of enterprises in Georgia was carried out by courts. After amending the Law on Entrepreneurs on the 24th of June 2005, the registration of entrepreneurs was carried out by tax authorities. Nowadays the enterprises are registered by Tbilisi National Agency of Public Registry. The main purpose of registration is development and improvement of the society and granting of the status of entrepreneur by the state to associations or separate natural persons residing on its territory and destined for operation of commercial activities, generation of profit, purchase, sell and etc. Noteworthy is that information on registration systems and other related information is public both in Georgia and in all European countries.¹¹

Joint Liability Company shall be a company where two or more partners are united to conduct a business jointly, under one trade name, to carry out independent and repeated entrepreneurial activities and in which the partners are liable to creditors of the company as joint debtors directly and to the extent of their whole property. Joint Liability Company may be founded by two or more natural persons and legal entities that are united to conduct a business jointly under one trade name, to carry out independent and repeated entrepreneurial activities. The company is liable to its creditors to the extent of the property of each partner.

Limited Partnership is a company similar to the Joint Liability Company. The main difference is existence of two categories of partners in the limited partnership – commandite and complementary. Liability of limited partnership to its creditors is limited by payment of the guarantee. Proceeding from concept of the company, its founder must be at least one complementary - personally liable partner and one commandite, whose liability to creditors is limited by payment of the guarantee.

Limited Liability Company shall be a company that's liability to creditors is limited to the extent of its property. Partner of the company does not bear responsibility for obligations of the company. Taking into account concept of the limited liability company, the company is founded by joint capital of its partners. Deposits may be paid to the capital by monetary and non-monetary property. Liability of the company to its creditors is limited and the company is liable only to the extent of its property. Partners of the company do not assume personal liability to creditors. Under settlement of a debt is meant coverage by the property that the partners have contributed to the authorized capital. Founders may be both natural person/persons and legal entity/entities. Founder of the Company may be also the state.¹² Manager of the company is director. The company may have several directors (financial, executive and so on).

The company is entitled to carry out any kinds of activities not forbidden under the legislation of Georgia; amount of the authorized capital is not specified by the law, it may be any sum or movable or real estate contributed by partners. At the end of each economic year the partners receive profit in proportion to their shares. This form of legal entity is the most popular in Georgia. The tendency to found a limited liability company is conditioned by various factors. In comparison with Joint Stock Company that has considerable capital, a Limited Liability Company has rather simple legal form and simplified structure of management. In addition to the aforesaid, the procedure of foundation a limited liability company is more liberal in comparison with a joint stock company and personal company. For a Limited Liability Company is typical so called "corporate coverage". This means that the partner of a limited liability company does not assume personal liability to creditors of the Company. In case of a personal company, the partner is liable for obligations of the company to the extent of his/her property. The Limited Liability Company as a legal form of an enterprise was for the first time specified in the Law of Georgia in 1991 when the law "On fundamentals of entrepreneurial activities" was passed. According to this law, a Limited Liability Company was recognized as one of the forms of an enterprise. Noteworthy is that enterprises similar to the limited liability company existed in Georgia already at the end of the 80s years. The enterprise where one of the partners was foreign natural person or legal entity was called "joint venture". Definition of a limited liability company has been changed for several times in the Georgian legislation. Definition of a limited liability company in Article 44, first edition of the law (1994) was established as follows: a Company having limited liability to creditors of the Company to the extent of its property, liability of partners of the company is limited to the extent of their shares in the authorized capital. General and specific signs of the company must be jointly characterized in order to demonstrate legal nature of the limited liability company.¹³ General features typical for a limited liability company: legal personality, entrepreneurship, corporation, capital (authorized capital property), liability to the extent of its property, exclusion of liability of partners for obligations of the Company and other.

I have briefly considered and compared also legal forms of enterprises existing in other countries. Basing on this comparison, we can conclude that nowadays legal regulation of private enterprises and business related activities in Georgia, the form of functioning and legal form of enterprises, correspond to general principles foreseen for arrangement of an entity of private law, subject and form of their activities. Taking into account that Georgia is a country with transition economy, the methods of legal regulation of separate issues and the area of their practical implementation are different. In whole, generally similar is private organizational and legal form of enterprises of open and market economy deter-

mined by legislations of various countries, their legal nature, fields of activities, terms of establishment and payment of deposits, financial accounting and rules of settlement, governing organs of enterprises and liability to creditors. The above-mentioned main principles insignificantly differ from each other depending on economic, political, democratic state and development of the country. This approach is conditioned by similar economic and social conditions existing in the civilized countries of the world as well as by worldwide recognized international legal norms regarding national normative acts.

References

- Selected corporation and partnership statuses, rules and forms.* (1994). St. Paul. Minn.
- Chanturia, L. *Significance of Guidelines and Resolutions on Corporate Legislation of Europe for Codification of Georgian Corporate Law.* P.447.
- Commercial Code of Germany.
- New Testament
- Zhamen, S. Lacur, L. (1993). *Commercial Law*, M. p. 37.
- Amilakhvari, Z., Amilakhvari, G., Tsereteli, N. (2010). *Business Law.* Second edition. p.26
- Bible, Ecclesiastes.
- Selected corporation and partnership statuses, rules and forms.* (1994). St. Paul. Minn.
- Bible, Old Testament.
- Chanturia, L. (2003). *Law on Entrepreneurs in Georgian legislation.* Liluashvili, T. 75 Anniversary Collection. Tbilisi. p. 11-30.
- Janezashvili, T. (2002). Entrepreneurial register in European countries. *Mahazine "Notarial system of Georgia", N 3-4*, p.81.
- Burduli, I. *Authorized capital and its functions.* p.208.
- Migriauli, R. (2004). *Legal aspects of bankruptcy of a Limited Liability Company.* p. 16.
- Liluashvili, G. (2009). *Essence and importance of registration of entrepreneur.* p. 139

Endnotes

¹ Lado Chanturia. Law on Entrepreneurs in Georgian legislation. Tengiz Liluashvili. 75 anniversary collection. Tb. 2003. p. 11-30.

² Bible, Ecclesiastes

³ Bible, Old Testament

⁴ New Testament

⁵ S. Zhamen, L.Lacur, Commercial Law, M. 1993, p. 37.

⁶ Zaur Amilakhvari, Giorgi Amilakhvari, Nino Tsereteli. Business Law. Second edition. 2010. p.26

⁷ Selected corporation and partnership statuses, rules and forms. St. Paul. Minn. 1994

⁸ Selected corporation and partnership statuses, rules and forms. St. Paul. Minn. 1994

⁹ Commercial Code of Germany

¹⁰ Lado Chanturia. Significance of Guidelines and Resolutions on Corporate Legislation of Europe for Codification of Georgian Corporate Law. P.447

¹¹ Tamaz Janezashvili. Entrepreneurial register in European countries. Journal "Notarial system of Georgia", 2002, N 3-4, p.81.

¹² Irakli Burduli. Authorized capital and its functions; p.208.

¹³ Roin Migriauli. Legal aspects of bankruptcy of a nLimited Liability Company. 2004.. p. 16.

Science and Technology

საქართველოს კვლევებისა და განვითარების სისტემა 1996-2005 წლებში

*გოგოძე სოსო
ტეხინფორმი
ურიდია მერაბი
საქართველოს უნივერსიტეტი*

სტატიაში წარმოდგენილი და გაანალიზებულია ძირითადი მაჩვენებლები, რომლებიც ასახავენ საქართველოს კვლევებისა და განვითარების სისტემის დინამიკას 1996-2005 წლებში, და განხორციელებულია მათი შედარება ევროპა-ცენტრალური აზიის რეგიონის შესაბამის მაჩვენებლებთან. მიღებული შედეგების ანალიზის შედეგად შეგვიძლია დავასკვნათ, რომ საანალიზო პერიოდში საქართველომ ვერ შეძლო კვლევებისა და განვითარების საკუთარი სისტემის სათანადო უზრუნველყოფა და რამდენადმე ეფექტურად მართვა.

Georgian Research and Development System in 1996-2005

*Gogodze Joseph
TECHINFORM
Uridia Merab
University of Georgia*

In the modern world the level of science and technology development becomes the most important precondition for the development of a given country and the wealth of its population.

The process of transition to a market economy entails gradual changes in the character of Research and Development institutions' activities, conditioned by their attempts to adjust to the new situation and survive under difficult financial conditions.

The aim of this paper is to study statistical characteristics of the Research and Development (R&D) system of Georgia in 1996-2005 and

compare them with corresponding characteristics of the R&D systems for the Europe-Central Asia region.

We consider main short-term and long-term tendencies, which characterize dynamics of personnel, management, and funding of the R&D system of the following two country groups: Countries of the Europe - Central Asia (ECA) region and successor-states of the former Soviet Union. As a result, we are able to position Georgia in relation to each of these two groups. The essential part of our analysis is based on the individual data of the ECA countries.

As a corollary of presented data, we conclude that in the period under study Georgia could not secure funding of its own R&D system and could not efficiently manage it. As a result, Georgia's R&D system became plagued with a significant shortage of personnel which is by no means restorable in a short time.

By the key indicators of the R&D system, Georgia is behind the leading Soviet successor states and has a very weak position in the ECA region overall.

Method

Data sources

The following information was collected to study R&D activities of the ECA countries in 1991-2005:

ResPat - number of patents granted to residents, according to the data of the World Intellectual Property Organization (WIPO).

Source: WIPO, <http://www.wipo.int/ipstats/en/statistics/patents/index.html>.

USPat - Number of patents granted by the United States Patent and Trademark Office (USPTO).

Source: USPTO, <http://www.uspto.gov/web/offices/ac/ido/oeip/taf/reports>.

EUPat - Number of patents granted by the European Patent Office (EPO).

Source: OECD; <http://stats.oecd.org/wbos/Index>.

Number of personnel involved in R&D.

Source: UNESCO; <http://stats.uis.unesco.org>.

Number of researchers.

Source: UNESCO; <http://stats.uis.unesco.org>.

R&D funds (% GDP).

Source: UNESCO; <http://stats.uis.unesco.org>.

Gross domestic product (in 2000 international US dollars).

Source: WB, <http://web.worldbank.org/website/external/datastatistics>.

Income groups according to the official classification of the World Bank.

Source: WB, <http://web.worldbank.org/website/external/datastatistics>.

Pop - number of resident population.

Source: WB, <http://web.worldbank.org/website/external/datastatistics>.

Sampling

In accordance with the classification of the World Bank, the total number of ECA countries is 56. Because of their specifics or specific phase of development, several countries show distinguished, non-typical innovation activity for the period 1995-2005. At the preliminary stage of research, we decided that it is expedient to separate these countries. For this purpose, we use demographic and patent activity criteria. At the first stage, we set aside countries with population less than 250,000 (the demographic criterion). According to this criterion, we left out the following countries: Andorra, Channel Islands, Faroe Islands, Greenland, Isle of Man, Liechtenstein, Monaco, and San Marino. At the second stage, we separate countries with total (international as well as domestic) average annual patent activity of less than 0.1 patent granted per 1 million residents in 1991-2005 (the patent activity criterion). According to this criterion, we excluded the following countries: Albania, Macedonia, Montenegro, and Serbia. Thus, the final sampling of ECA region countries consists of 44 states (Table1).

Final sampling of ECA countries							
ARM	Armenia	FIN	Finland	LTU	Lithuania	SWE	Sweden
AUT	Austria	FRA	France	LUX	Luxembourg	CHE	Switzerland
AZE	Azerbaijan	GEO	Georgia	MDA	Moldova	TJK	Tajikistan
BLR	Belarus	DEU	German	NLD	Netherlands	TUR	Turkey
BEL	Belgium	GRC	Greece	NOR	Norway	TKM	Turkmenistan
BIH	Bosnia-Herzegovina	HUN	Hungary	POL	Poland	UKR	Ukraine
BGR	Bulgaria	ISL	Island	PRT	Portugal	GBR	United Kingdom
HRV	Croatia	IRL	Ireland	ROM	Romania	UZB	Uzbekistan
CYP	Cyprus	ITA	Italy	RUS	Russian Fed.	UK	United Kingdom
CYP	Czech	KAZ	Kazakhstan	SVK	Slovak Rep.		
DNK	Denmark	KGZ	Kirghiz Rep.	SVN	Slovenia		
EST	Estonia	LVA	Latvia.	ESP	Spain		

Data preparation

Preliminary analyses show that the difference between the R&D activities of the countries also depends on the category of income they belong to. Considering this circumstance and the small size of sampling, we group countries into two classes – Lower-income countries and Upper-income countries. Our classification amalgamates the official classification of the World Bank, which is based on special methodology and groups countries into four different classes: Low-income countries, Lower-middle-income countries, Upper-middle-income countries, and High-income countries. The group of countries with Upper-income in our classification consists of countries, which by the World Bank classification, are placed in the group of High-income and Upper-middle-income. The group of countries with Lower-income consists of countries, which by the World Bank classification are placed in the group of Low-income and Lower-middle-income. The totality of the group of countries with Lower-income had been changing to some extent in years 1991-2005, but in essence it is represented by the countries of the former Eastern Bloc.

We also present data which reflect dependence of the effectiveness of the R&D system in the institutional environment in which it is functioning. We estimate the functioning quality of the R&D system by the patent activity. We use the following relative indicators: ResPatPop, USPatPop, and EUPatPop. These indicators represent patent activity per one million inhabitants:

$\text{ResPatPop} = 10^6 \text{ ResPat/Pop}$, $\text{USPatPop} = 10^6 \text{ USPat/Pop}$, $\text{EUPatPop} = 10^6 \text{ EUPat/Pop}$.

Essential correlation between the indicators USPatPop and EUPatPop suggests unifying them in one integrated indicator of the international patent activity:

$\text{IntPatPop} = \text{USPatPop} + \text{EUPatPop}$.

There is one more reason which justifies introduction of this integrated indicator. Preliminary analysis shows that in the period under study the ECA region countries with lower-income did not have distinct preferences while choosing patent offices for international patent aims. We think that analysis conducted on the basis of patents granted only by USPTO or EPO patent offices would detract from the real estimation of possibilities of countries with Lower-income.

To characterize the institutional environment in which the R&D system is functioning, we use six indicators of governance quality which has been tracked by the World Bank since 1996 (Kaufmann, Kraay, & Mas-truzzi, 2009). The indicators reflect a relative condition of the country by the following six attributes of governance quality:

Voice and Accountability (VA) – capturing perceptions of the extent to which a country's citizens are able to participate in selecting their gov-

ernment, as well as freedom of expression, freedom of association, and a free media.

Political Stability (PS) – capturing perceptions of the probability that the government will be destabilized or overthrown by unconstitutional or violent means, including politically-motivated violence and terrorism.

Government Effectiveness (GE) – capturing perceptions of the quality of public services, the quality of the civil service and the degree of its independence from political pressures, the quality of policy formulation and implementation, and the credibility of the government's commitment to such policies.

Regulatory Quality (RQ) – capturing perceptions of the ability of the government to formulate and implement sound policies and regulations that permit and promote private sector development.

Rule of Law (RL) – capturing perceptions of the extent to which agents have confidence in and abide by the rules of society, and in particular the quality of contract enforcement, property rights, the police, and the courts, as well as the likelihood of crime and violence.

Control of Corruption (CC) – capturing perceptions of the extent to which public power is used for private gain, including both petty and grand forms of corruption, as well as "capture" of the state by elites and private interests.

Described indicators strongly correlate. This is the reason why we use an integrated indicator of governance quality.

$$G = (VA + PS + GE + RQ + RL + CC) / 6.$$

Results

In 1996-2005, the R&D system of Georgia was characterized by a sharp decline of financial and personnel security. This situation can be explained by two main factors. First is the combination of influences generally characteristic of transition economics (Radosevic, 2003). The second factor is reflects the specific circumstances characteristic of Georgia.

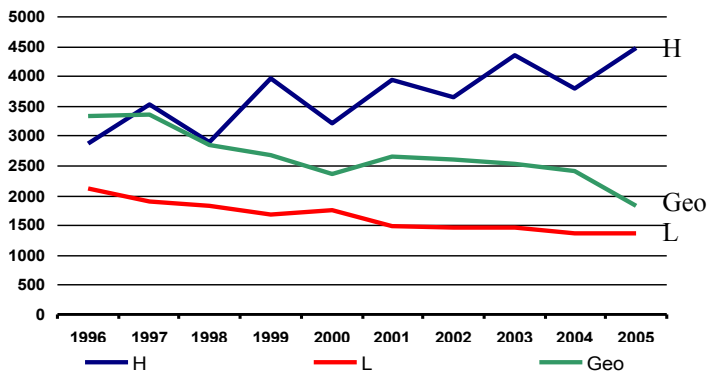

Fig.1.

Researchers (HC) per 1 million inhabitants.
 H-ECA countries with Upper-income.
 L-ECA countries with Lower-income. Geo- Georgia.

In the period under study, the number of researchers in the R&D system of Georgia per one million inhabitants has significantly decreased. The range of decrease in the period 1996-2005 varies from approximately 3,500 to 1,800 persons per one million inhabitants. In 1996, this number was in close correspondence with the average number of researchers per one million inhabitants for Upper-income ECA countries. In 2005 this number practically became equal to average number of researchers per one million inhabitants for Lower-income ECA region countries (Fig.1).

As far as Georgia belongs to the group of ECA region countries with Lower-income, one may consider these circumstances less important. On the other hand, if we take into consideration all the difficulties inevitably associated with reproduction of scientific personnel, we definitely have a reason to worry. Comparison with the former Soviet States (Fig. 2) shows that the Baltic states, which are demographically close to Georgia, managed much better in taking care of their scientific personnel. In particular, the number of researchers in Estonia in 2005 came closer to the average index of counties with Upper-income. We think this fact is directly connected with Estonia's progress in the development of knowledge-oriented highly effective economy.

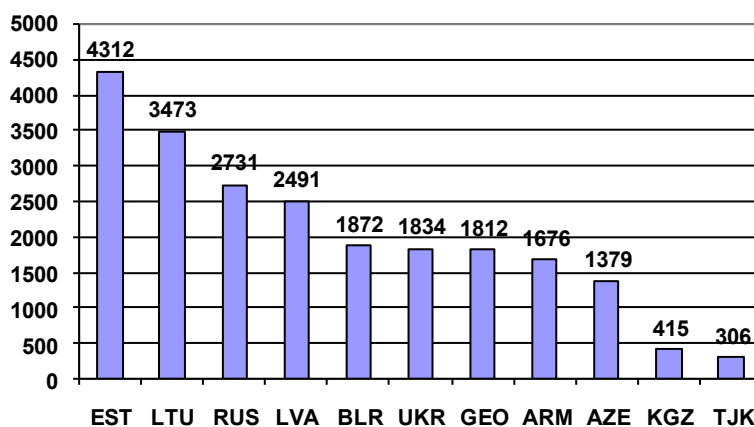

Fig.2. Researchers (HC) per 1 million inhabitants, former USSR countries, 2005

The structure of the R&D personnel in Georgia has changed essentially. In particular, the share of researchers in the whole R&D personnel decreased significantly from 85% in 1996-1998 to 60% in 2005. Note that at the beginning of 21st century the average of this indicator for the EU member-states was 59% and for the non-EU states from the ECA region - 65%. Thus, one may say that Georgia approaches the "European level," but on the other hand the specific pattern in Georgia in 1996-2005

was that, simultaneously with the 3.3% average annual decrease in the number of the R&D personnel and 6.8% decrease in the number of researchers, the annual growth in the number of assistant personnel was on average 10.3%.

Gross domestic expenditure on R&D (GERD) as % of the GDP reached its minimum in 2000 at about 0.2% and has stayed steady on this level until 2006 (Fig. 3). This is two times less than the average levels of this indicator for the Lower-income countries of the ECA region. Note that in 2001-2005 this indicator in Estonia was 0.8%, in Russia -1.19% (Fig. 4), and the average for the Upper-income ECA countries was approximately 1.5%.

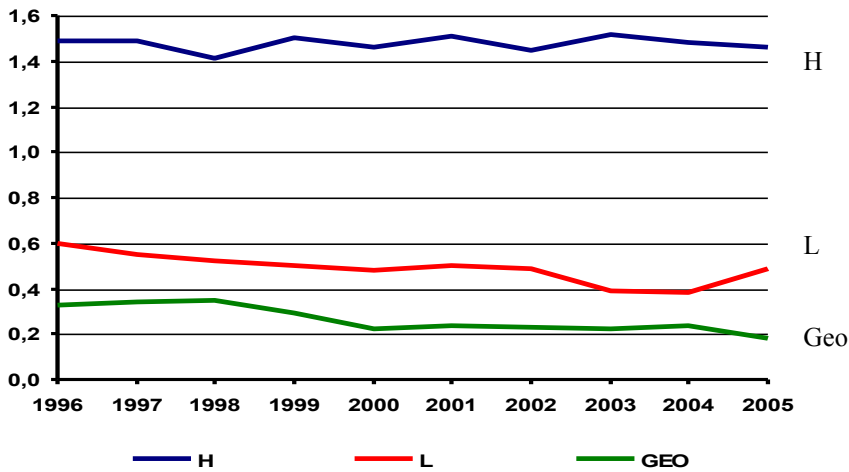

Fig.3. Gross domestic expenditure on R&D (%GDP)
 H-ECA countries with Upper-income.
 L-ECA countries with Lower-income.
 Geo-Georgia.

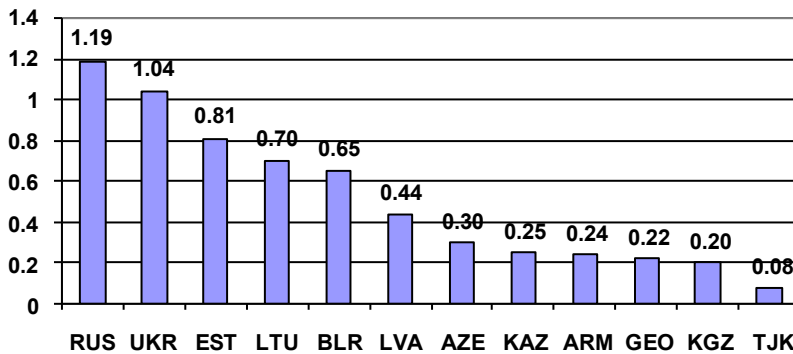

Fig.4. Gross domestic expenditure on R&D (%GDP), former USSR countries, 2005

The picture is even more dramatic when we consider the comparison of R&D funds per one researcher (Fig. 5). In particular, in 2005 Georgian R&D funds in total were 2,972 \$PPP 2000 which is practically 10 times less than the same indicator for Russia, Ukraine, the Baltic states, and Belarus (Fig. 6).

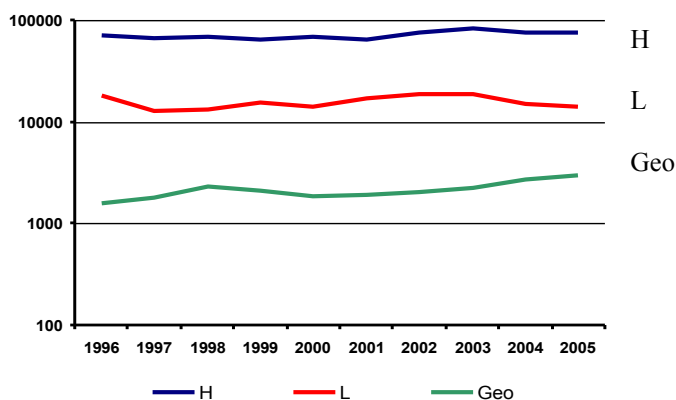

Fig.5. Gross domestic expenditure (USD-2000 PPP per Researcher)
 H-ECA countries with Upper-income.
 L-ECA countries with Lower-income.
 Geo-Georgia.

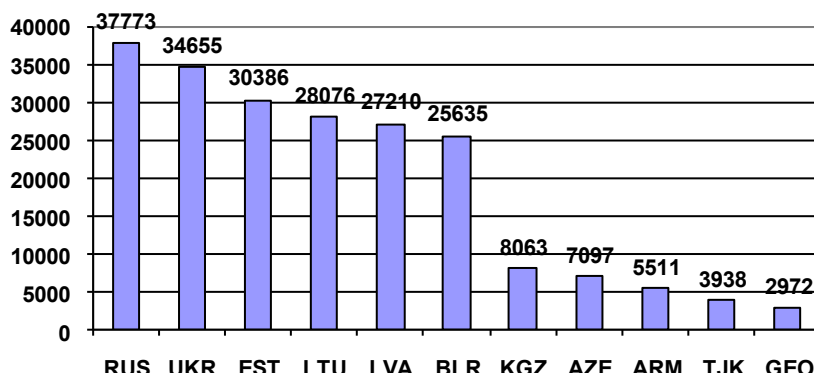

Fig.6. Gross domestic expenditure (USD-2000 PPP per Researcher) former USSR countries, 2005

We must mention that the sharp decrease of financial support for the R&D sector in Georgia began in 1991, when the USSR as well as the Soviet R&D system stopped functioning. This was the period, when Georgia (as well as other Soviet successor states) began to take care of its own R&D system independently. It is a deplorable fact that for objective or subjective reasons – mainly because of the lack of necessary political will - Georgia failed to manage its R&D system to any extent. Moreover, Georgia could not even find the necessary funds to protect its R&D system from structural disintegration.

We also have to mention that no data concerning formation and distribution of funds for the R&D system of Georgia could be found in the UNESCO database. Neither can one find any trends of expenditure of these funds in the years 1995-2005. This means that aforementioned data was not delivered to the UNESCO or quality of the data was unsatisfactory. It is only natural to suppose that this fact in itself reflects the approach to the R&D system from the general institutional point of view. It also reveals the level of government management of this area in the period 1995-2005. The influence of the general institutional environment on the quality of functionality of the R&D system is proved by the following observation. If we consider IntPatPop and ResPatPop as indicators of the quality of functionality of the R&D system in a given country and G as an indicator of the institutional environment of this country, then after necessary calculation we will see that the natural logarithm of IntPatPop - $\ln(\text{IntPatPop})$ is strongly correlated with G in the positive direction (coefficient of correlation $k=0.89$). This shows the importance of the general institutional environment on the functionality of the R&D system. We have to mention one consequence of the conducted analysis. There is an interesting observation about how the indicator G relates with the residential patent activity. If we exclude from sampling Armenia, Georgia, Moldova, Russia, Ukraine, and Uzbekistan (we have to point out that we could not get data for domestic patent activity in 2005 of Azerbaijan, Belarus, Kazakhstan, Kyrgyz Republic, Tajikistan, and Turkmenistan), then the indicator G and $\ln(\text{ResPatpop})$ are strongly correlated in the positive direction with coefficient $k=0.68$, whereas the coefficient of correlation k is equal to 0.35 if these countries are included in the sample. We hypothesized that the patent offices of these countries overestimate the degree of innovation in the work of resident inventors. This also characterizes the institutional environment in which the R&D system of Georgia is functioning. Certainly this fact is a post-Soviet "syndrome" and is not characteristic of Georgia only.

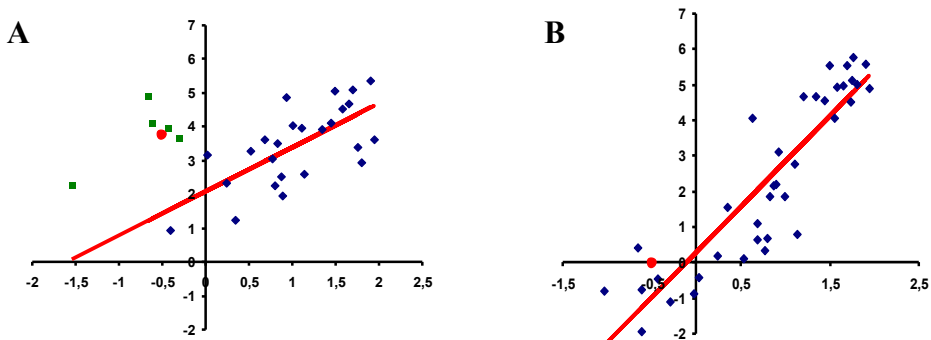

Fig.7. Relation between patent activity and governance quality 2005
 A) Vertical axis – $-\ln(\text{ResPatPop})$ B) Vertical axis – $-\ln(\text{IntPatPop})$; Horizontal axis – Governance Quality Indicator G. Star-Georgia, Squares-former USSR republics except Baltic States, Rhombuses-other countries from sampling.

After becoming independent, Georgia began to resume inner patent activity only in 1993 and granted first 19 patents to its residents. First international patent (registered in USPTO) was granted to residents of Georgia in 1995. In total in years 1991-2005 Georgia granted 2053 patents to its residents. Also residents of Georgia obtained 38 international patents (registered in USPTO and EPO), from which 20 were done with co-authorship with foreign colleagues (1 with a resident of Czech Republic, 2-Germany, 4-UK, 1-Finland, 6-US, and 11-Russia). Table 2 gives the structure according to main sections of the international patent classification (IPC) of the stream of patents registered in patent offices of Europe and US in years 1991-2005.

Table 2.

		World	Georgia
A	HUMAN NECESSITIES	14.6%	46.0%
B	PERFORMING OPERATIONS, TRANSPORTING	19.2%	-
C	CHEMISTRY, METALLURGY	13.2%	4.0%
D	TEXTILES, PAPER	1.3%	-
E	FIXED CONSTRUCTIONS	2.8%	-
F	MECHANICAL ENGINEERING, LIGHTING, HEATING, WEAPONS, BLASTING	8.4%	9.7%
G	PHYSICS	21.7%	11.0%
H	ELECTRICITY	18.8%	29.3%

As described on the diagram below, in 1991-2005 the international patent activity of Georgia has middle rating among former Soviet states (Fig.8). At the same time, Georgia is far behind the leaders of this group.

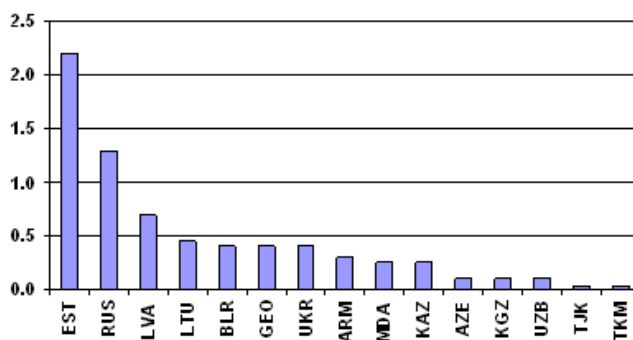

Fig.8. Patents granted by UPSTO and EPO (Unit per 1 000000 inhabitants) former USSR countries, 1991-2005

Probably this circumstance has systematic character and middle average rating of patent activity of Georgia is explained by the influence of certain inertial factors. The same is shown by analysis of the annual patent activity (Gogodze I., Chubinishvili T. 2009). It seems that the R&D system of Georgia is exploiting its early achievements and this resource is probably being exhausted in short time.

Discussion

By analyzing the statistical data presented above, we conclude that in the period under study:

- The R&D system of Georgia suffered from a significant shortage of personnel which is by no means restorable in a short time.
- Due to certain circumstances, in particular because of the lack of political will, Georgia could not protect its R&D system by adequately funding it and therefore could not effectively govern it.

As a result, from the point of view of its productivity, Georgia's R&D system does not display a distinct tendency of growth in the period under study. This shows its orientation on exploitation of the early achievements. Thus, by the key indicators of the R&D system, Georgia is rather behind the leading Soviet successor state and has a very weak position in the ECA region. This is determined by causes of a systemic character and is related to several factors, which negatively affect the functionality of the R&D system of Georgia.

Presented material underlines the following problems:

- Disintegration of the old structure of relations in the science and technology sector and difficulties creating a new one.
- Disadvantageous institutional environment for innovational activity.
- A lack of clear goals and policy in the R&D sector.

The listed factors as well as other reasons had a negative impact on the effectiveness of the R&D system of Georgia in the period under study.

We think that investigation of the factors (non-advantageous as well as assistant), which define the functionality of the R&D system of Georgia, and analysis of their quantity must be a subject of detailed future research. This kind of research will definitely be an important step towards determination of a necessary policy for raising the effectiveness of the R&D system of Georgia.

References

- Gogodze I., Chubinishvili T. (2009). Innovation potential of Georgia: Analyze of patent activity. *Economica (Georgian)* 5-6, 142-154.
- Kaufmann D., Kraay A., & Mastruzzi M. (2005). Governance Matters V: Aggregate and individual governance indicators for 1996–2005. *The World Bank, WPS4012*.
- Radosevic S., (2003). Patterns of preservation, restructuring and survival: science and technology policy in Russia in post-Soviet era. *Research Policy*, 32, 1105-1124.